



PROGRAMOVATELNÉ AUTOMATY

Peripheral modules on CIB Common Installation Bus®

TXV 004 13.02

Peripheral modules on CIB bus

TXV 004 13.02

1. edition - January 2014

CONTENT

1. INTRODUCTION	3
1.1. CIB - COMMON INSTALLATION BUS	3
2. CIB MASTER.....	3
2.1. MASTER CONFIGURATION.....	9
2.2. THE STRUCTURE OF THE TRANSMITTED DATA	12
2.3. POWER CIB BUS.....	14
3. CIB UNITS, MODULES.....	17
3.1. C-AM-0600I.....	18
3.2. C-AQ-0001R	23
3.3. C-AQ-0002R	26
3.4. C-AQ-0003R	29
3.5. C-AQ-0004R	31
3.6. C-DL-0012S	33
3.7. C-DL-0064M	37
3.8. C-DM-0006M-ILED	41
3.9. C-DM-0006M-ULED	45
3.10. C-DM-0402M-RLC	48
3.11. C-HC-0201F-E.....	57
3.12. C-HM-0308M	64
3.13. C-HM-1113M	69
3.14. C-HM-1121M	74
3.15. C-IB-1800M.....	79
3.16. C-IR-0202S	85
3.17. C-IR-0203M.....	91
3.18. C-IT-0100H-A	98
3.19. C-IT-0100H-P.....	101
3.20. C-IT-0200I	104
3.21. C-IT-0200R	108
3.22. C-IT-0200S.....	111
3.23. C-IT-0504S.....	116
3.24. C-IT-0908S.....	122
3.25. C-OR-0008M	128
3.26. C-OR-0202B	131
3.27. C-RC-0002R	135
3.28. C-RC-0003R	139
3.29. C-RI-0401S	146
3.30. C-WG-0503S.....	152
3.31. C-WS-0200R.....	158
3.32. C-WS-0400R.....	161
3.33. C-WS-0200R-LOGUS	164
3.34. C-WS-0400R-LOGUS	170
3.35. RCM2-1	176
4. ATTACHMENTS.....	180

1. INTRODUCTION

The manual is intended to inform the user of PLC Tecomat Foxtrot with modules working on the CIB bus. It provides information about the basic parameters of modules and their operation. CIB, including their individual elements, is referred under the trademark **CFox**.

1.1. CIB - Common Installation Bus

CIB - Common Installation Bus is two wire installation bus. CIB modules are both powered and communicated over this two-wire bus.

The CIB bus has always one control master and up to 32 slave modules (units). Master can be an internal part of the central module or can be as expansion unit on the DIN rail in the control panel. CIB peripheral modules are delivered in several form factors - for interior installations as well as for DIN rail installation

Tab. 1.1 Basic parameters of the CIB bus

Number of wires ^{*)}	2
Cross-section of wires ^{*)}	min. 0.8 mm ²
Topology ^{*)}	Arbitrary
Distance of the master from CIB slave module	max. 500m
Typical Voltage	24V DC (no backup) 27.2V DC (backup)
Tolerance of the supply voltage	20.4 ÷ 30V
The baud rate	19,2 kb/s

^{*)} It is recommended for CIB installation to use the twisted pair cable with the wire cross section at least 0,8 mm², e.g.. J-Y(St)Y1x2x0,8. The cross section and topology is necessary to choose with respect to the voltage drop along the cable - according to amount and type of CIB modules.

For more details and CIB application examples see. *Příručka projektanta systémů Foxtrot (TXV 004 11)*.

NOTE : With respect with CIB bus the term *CIB peripheral module* is equal with the term *CIB peripheral unit*.

2. CIB MASTER

CIB master communicates with CIB peripheral modules and transfers the data into the central module over the system bus TCL2. The CIB master is available in two versions. As the internal master or as external master. Internal master is inherent part of the central modules Tecomat Foxtrot (CP-10xx), where it is referred as module CF-1140, (or MI2-01M). External master is connected to the Foxtrot over the system communication bus TCL2 and is referred as module CF-1141, (or MI2-02M).

CIB MASTER

Internal master contain 1 CIB branch (for up to 32 CIB slave modules), internal master of CP-1000/1001 and external master contains 2 CIB branches (2x up to 32 CIB slave modules). Beside to internal CIB master CPU Tecomat Foxtrot enables to serve up to 4 external CIB masters.

Since 2011 the family of CPU Tecomat Foxtrot are modernized. From the point of view of the CIB buses the modernization brings replacement of the former MI2-01M a MI2-02M masters by the new one with the names CF-1140 and CF-1141 (for comparison see more below).

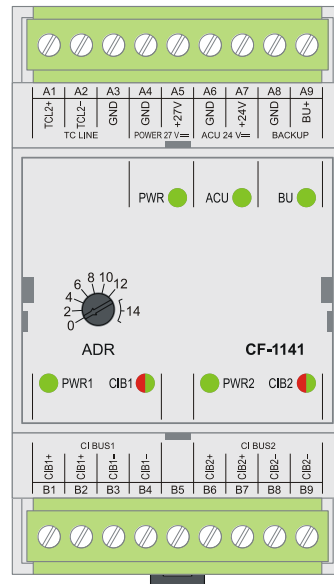

Fig. 2.1 Front view CF-1141

Tab. 2.2 Basic parameters of CF-1141 module

CF-1141	
System bus	TCL2
The installation bus	2x CIB (2x up to 32 modules)
Load of CIB line	max. 1A (for each CIB line)
Nominal Input Voltage	24V and 27.2V DC
Tolerance of the input voltage	20.4 ... 30V DC
Backup accumulator voltage	24V DC
Max. Load	60W
Self consumption	24mA
Dimensions	52 x 100 x 60mm
Weight	120g
Operating temperature	0 .. +70°C
Storage temperature	-25 .. +85°C
Operation position	arbitrary
Type of operation	continuous
Installation	on DIN rail
Connecting	Removable screw type terminal
Cross-section of wires	max. 2.5mm ²

Module CF-1141 provides a full internal power for CIB lines (it contain internal decoupling element for load capacity of 1A). Module also allows connecting and charging the backup battery that can power both the CIB lines as well as the PLC central module

1.1. CIB - Common Installation Bus

(the output terminals BACKUP). For connection see following chapter *Connection of the CIB line to the master*.

Tab. 2.3 Connection of the CF-1141 terminals

Terminal	Signal	Description
A1	TCL2+	data signal of the system bus TCL2
A2	TCL2-	data signal of the system bus TCL2
A3,A4,A6,A8	GND	ground terminal
A5	+27V	power supply 24V DC (bus without back-up) 27.2V DC (bus with back-up)
A7	+24V	power from the backup battery 24V DC
A9	BU+	back-up power supply 24 / 27V DC (BACKUP)
B1, B2	CIB1+	CIB line 1
B3, B4	CIB1-	CIB line 1
B6, B7	CIB2+	CIB line 2
B8, B9	CIB2-	CIB line 2

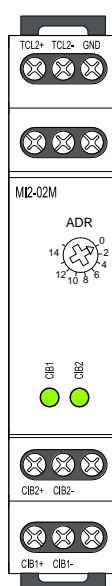

Fig.2.2 Front view MI2-02M

Tab. 2.4 Basic parameters of MI2-02M

MI2-02M	
System bus	TCL2
The installation bus	2x CIB (2x up to 32 modules)
Nominal input voltage (SELV) / own consumption	24V a 27.2V DC / 25mA from the bus CIB
Tolerance of the input voltage	20.4 ... 30V DC
Max. load	2.5W
Galvanic isolation	No
Dimensions	90 x 18 x 65mm
Weight	75g
Operating temperature	-20 .. +55°C
Storage temperature	-30 .. +70°C
Electrical strength	according to EN 60950
Degree of protection	IP 30
Overvoltage category	III
Degree of pollution according EN 61131-2	2
Operating position	arbitrary
Installation	on DIN rail

CIB MASTER

Connecting	screw type terminals
Cross-section of wires	max. 2.5mm ²

Module MI2-02M does not contain the decoupling element to power the CIB lines. Lines have to be supplied externally by using decoupling modules, see chap. [2.3 Supplying of the CIB bus](#).

Tab. 2.5 Connection of the MI2-02 terminals

Signal	Description
TCL2+	data signal of the system bus TCL2
TCL2-	data signal of the system bus TCL2
GND	signal ground
CIB1+	CIB line 1
CIB1-	CIB line 1
CIB2+	CIB line 2
CIB2-	CIB line 2

Connecting the internal master module to the PLC TECOMAT Foxtrot

Connecting the internal master (CF-1140 or MI2-01M) is done by internal circuitry of CPU without any additional outside interconnections.

Connecting the external master module to the PLC TECOMAT Foxtrot

The external master (CF-1141 or MI2-02M) is connected to the PLC Foxtrot via the interface circuits on terminals A1 to A3 marked as TC LINE.

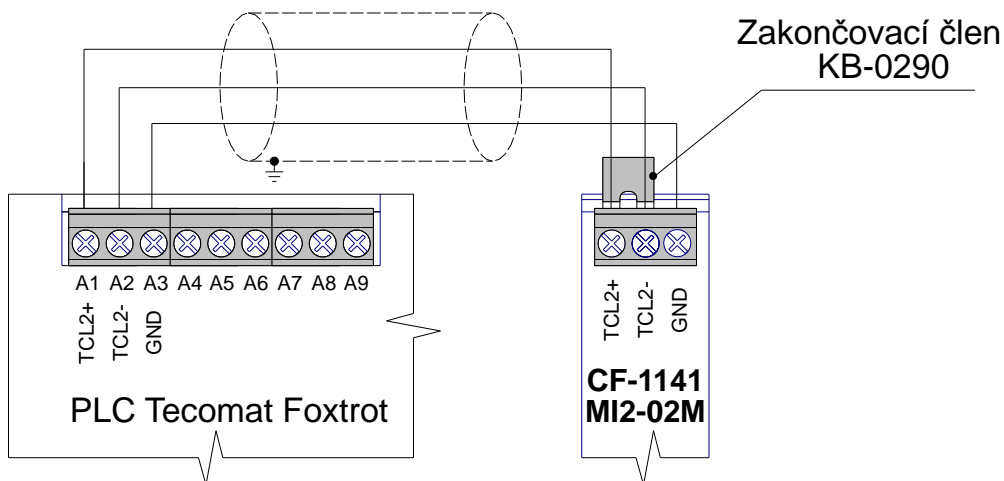

Fig. 2.3 Connecting the external master module to the PLC TECOMAT Foxtrot

On the PLC side the communication line TCL2 is terminated inside the PLC module. On the side of master module it is necessary to do the termination. This is achieved by using a terminating element KB-0290 (TXN 102 90) connected between the terminals TCL2+ and TCL2-. The terminator is a part of package PLC Foxtrot. If there are other modules the communication line TCL2, termination has to be placed at the end of the whole line!!

1.1. CIB - Common Installation Bus

Connecting CIB line to the master module

CIB line is connected to the master module via terminals + CIB and CIB-. If the CIB line has to be powered by an external power source, the power source must be separated from the CIB line by the decoupling module C-BS-0001 or BPS2-02M. Some CIB lines are fully (or partially) supplied directly from internal circuits of the master (see chap. [2.3 Supplying of the CIB bus](#)).

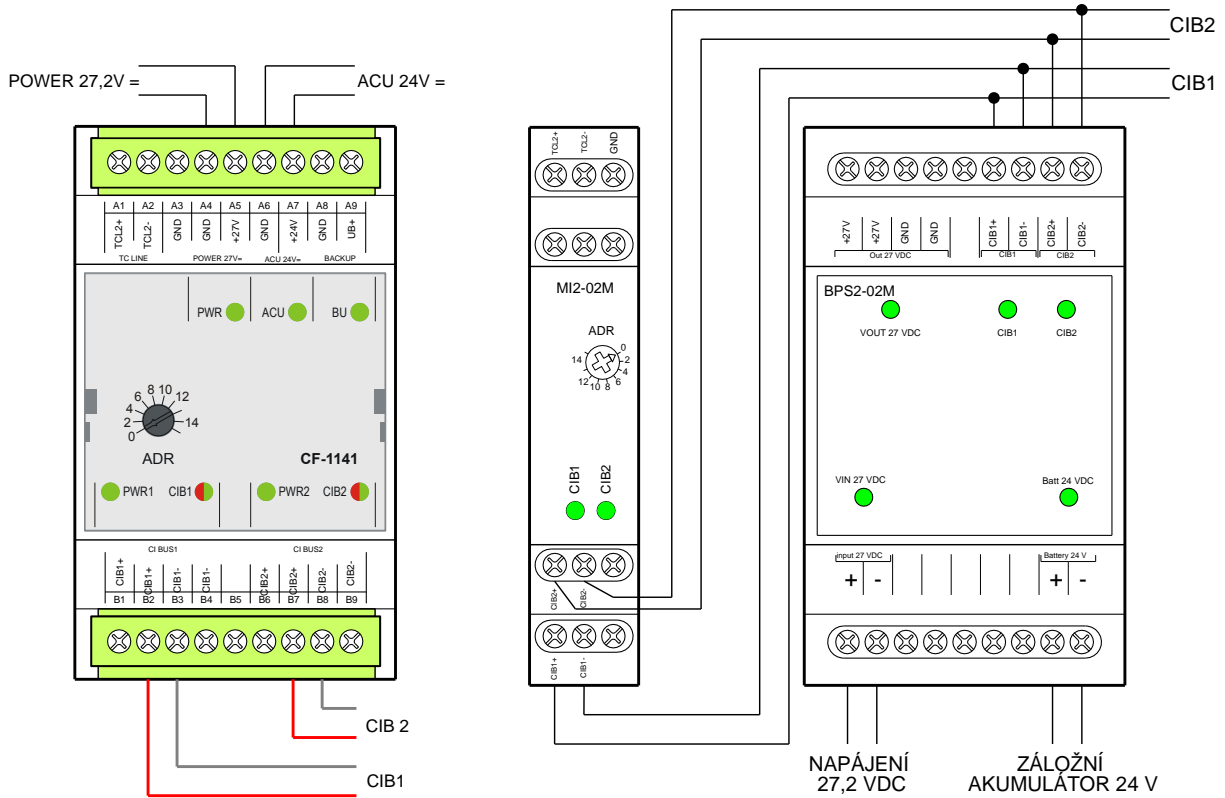

Fig.2.4 Connecting CF-1141 to CIB line

Fig.2.5 Connecting MI2-02M to CIB line by BPS2-02M

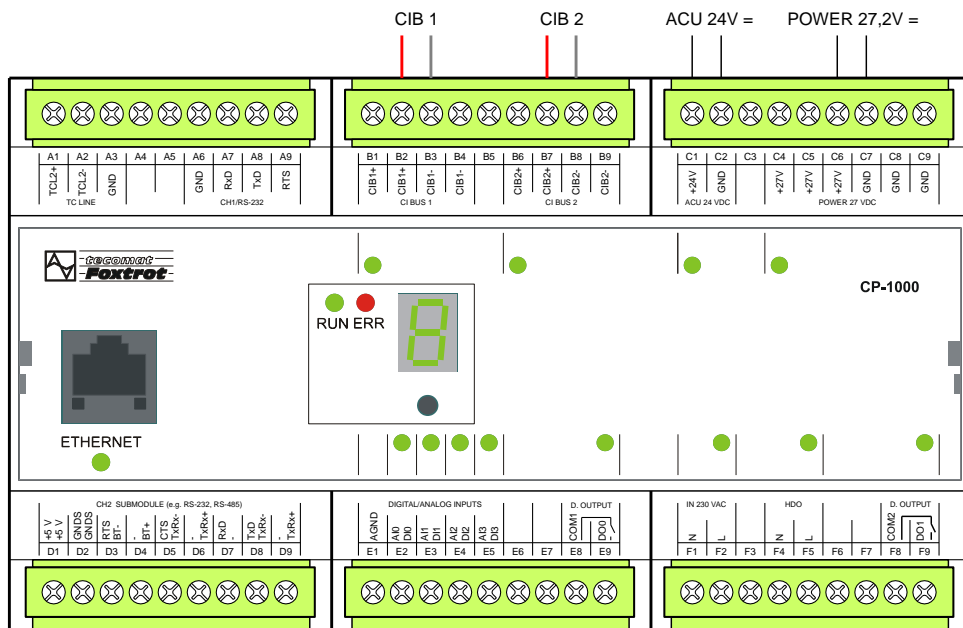

Fig.2.6 Connecting of the basic module Foxtrot CP-1000 to the CIB line

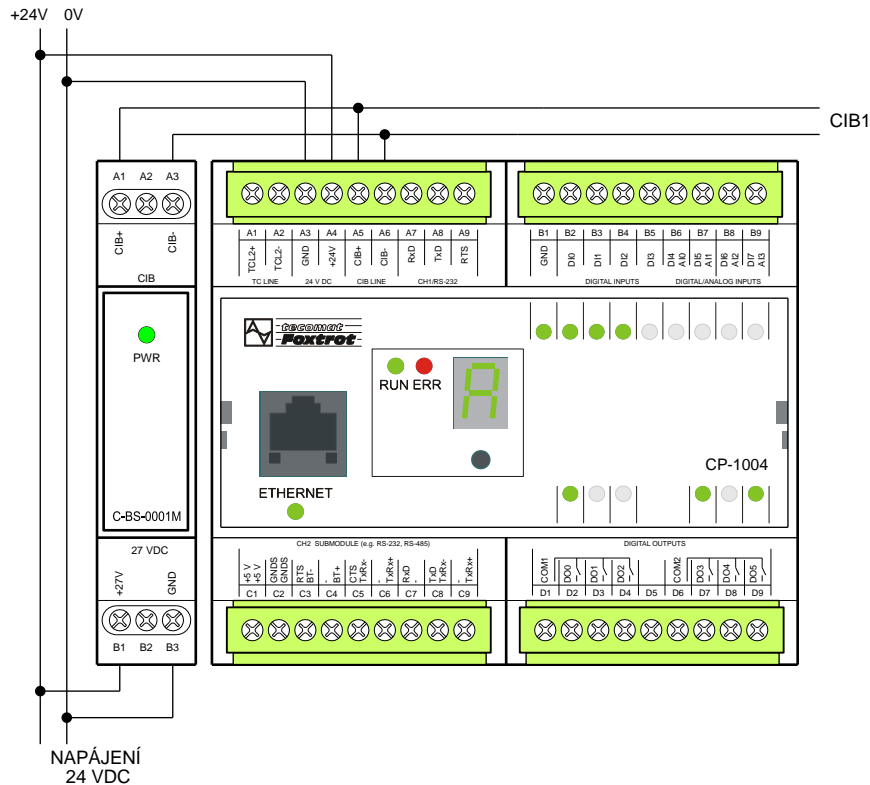

Fig. 2.7 Connecting of the basic module Fox trot CP-1004 to the CIB line with C-BS-0001M

Communication parameters

Master module communicates with the CPU by system messages of the bus TCL2. Parameters of communication are fixed by the specification of the TCL2 bus.

In terms of addressing on the TCL2 the internal CIB master is firmly mapped in the frame number 0, slot 2

For CIB lines of external master its communication address is set by the rotary switch on the front cover of the module. By setting its address, the module is uniquely addressed on TCL2 bus. This addressing must be done with respect to the addresses of other participants TCL2 to avoid address collisions. So the external CIB master module (resp. its two CIB lines) will be mapped always in the frame 3. Address of the line CIB1 of respected master will be equal to the position of the rotary switch, address of the line CIB2 of the same master will equal to the position of rotary switch incremented by +1.

Indicators

For the internal master no indicators are on the front panel of CPU.

On the front panel of external master there are two LED indicators(CIB1 a CIB2), each for the signalisation of the traffic on respective CIB line. In case of still green light of LED the CIB is in HLAT mode. (No connected module is served). In case of blinking green light of LED, module is in RUN mode (slave modules are serviced) and all serviced slave modules communicates. Blinking red among the green blinking in RUN mode indicates the communication failure of some slave module on the line.

2.1. Master configuration

On the external master CF-1141 there are additional 5 LED indicators (PWR, ACU, BU, PWR1, PWR2) monitoring the voltage level of the individual sections of the master. In the normal state all 5 LED still light. In case of voltage drop below the 22V limit, corresponding LED will blink (or turns off completely).

Limitations and comparison of master module MI2-01M with CF-1140 and MI2-02M with CF-1141

Modules **MI2-01M** and **MI2-02M** enables to serve **up to 32** CIB slave modules on one CIB line. Because of the limits of module memory, however there are some limitations in the real number of slave modules. In practice, there may be cases where these masters are actually able to serve fewer modules than the specified maximum value of 32 modules on one line CIB. These cases occur particularly in the cases where there is e.g. vast majority of the modules of the same type on one CIB line.

Modules **CF-1140** and **CF-1141** have much higher memory capacity, which enable to serve **really 32** slave modules on one CIB line.

Information about the used memory capacity of the specific CIB line can be seen on the bar graph in *unit/device manager* (see. fig. 2.9).

2.1. Master configuration

Adding new master in the PLC Tecomat Foxtrot configuration is done by dialog *HW Configuration* in *Project Manager*. CPU Tecomat Foxtrot allows handling one CIB line using the internal master (CF-1140, MI2-01M) and up to 8 external CIB lines using 4 external masters (both external masters CF-1141 and MI2-02M contain 2 CIB lines).

Activation of the operator's internal master is done in menu *Central module*.

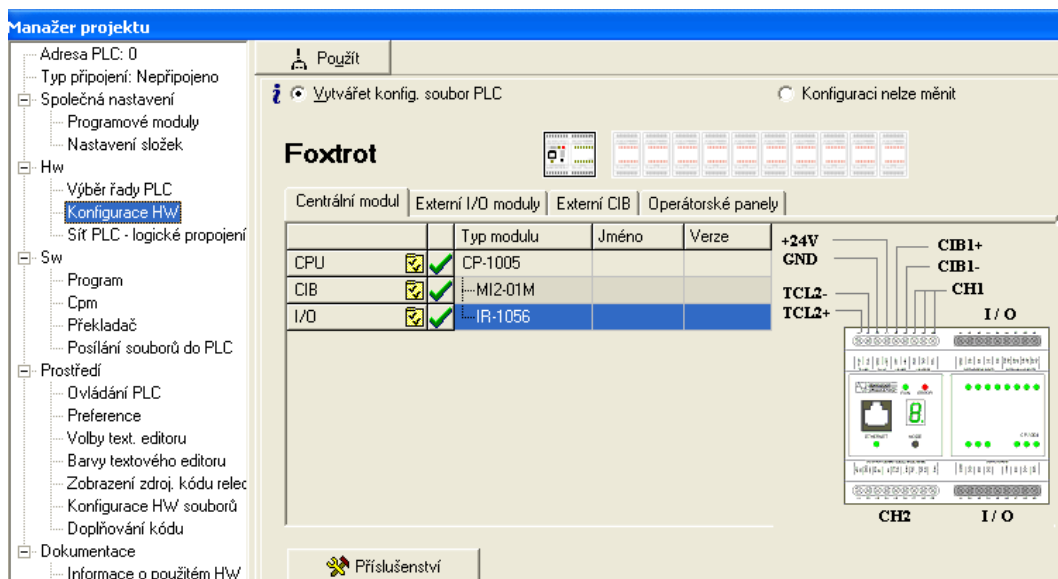

Fig. 2.8 Activation of serving of the internal CIB master

Adding new external master in the PLC Tecomat Foxtrot configuration is done by the same dialog in menu *External CIB* .

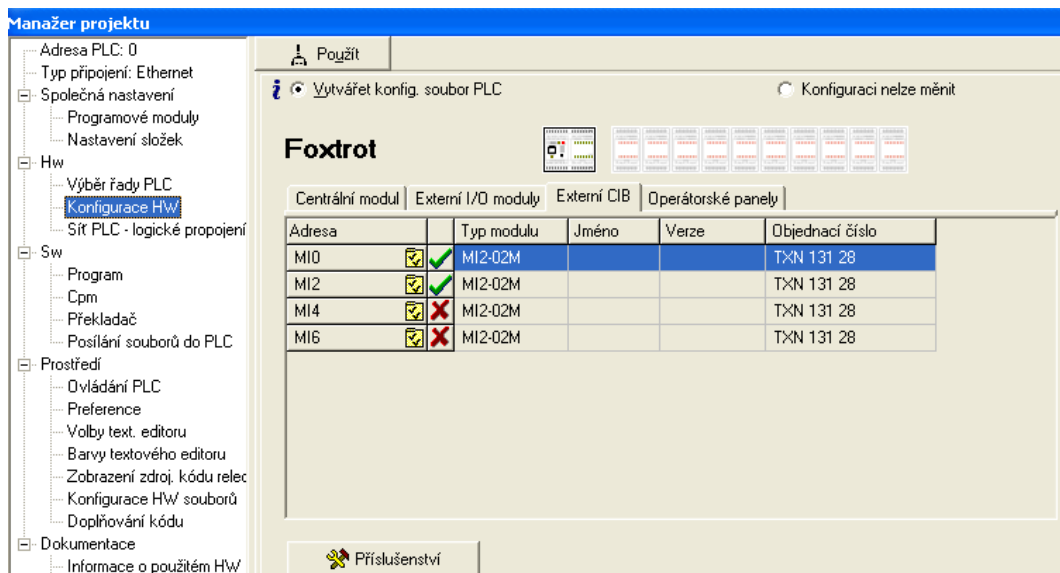

Fig. 2.9 Activation of serving of the external CIB master

SW configuration of master to serve the modules on CIB bus is performed in dialog *Unit/device manager*. Dialog is available in the window *HW Configuration* after the click on icon on the line of the master.

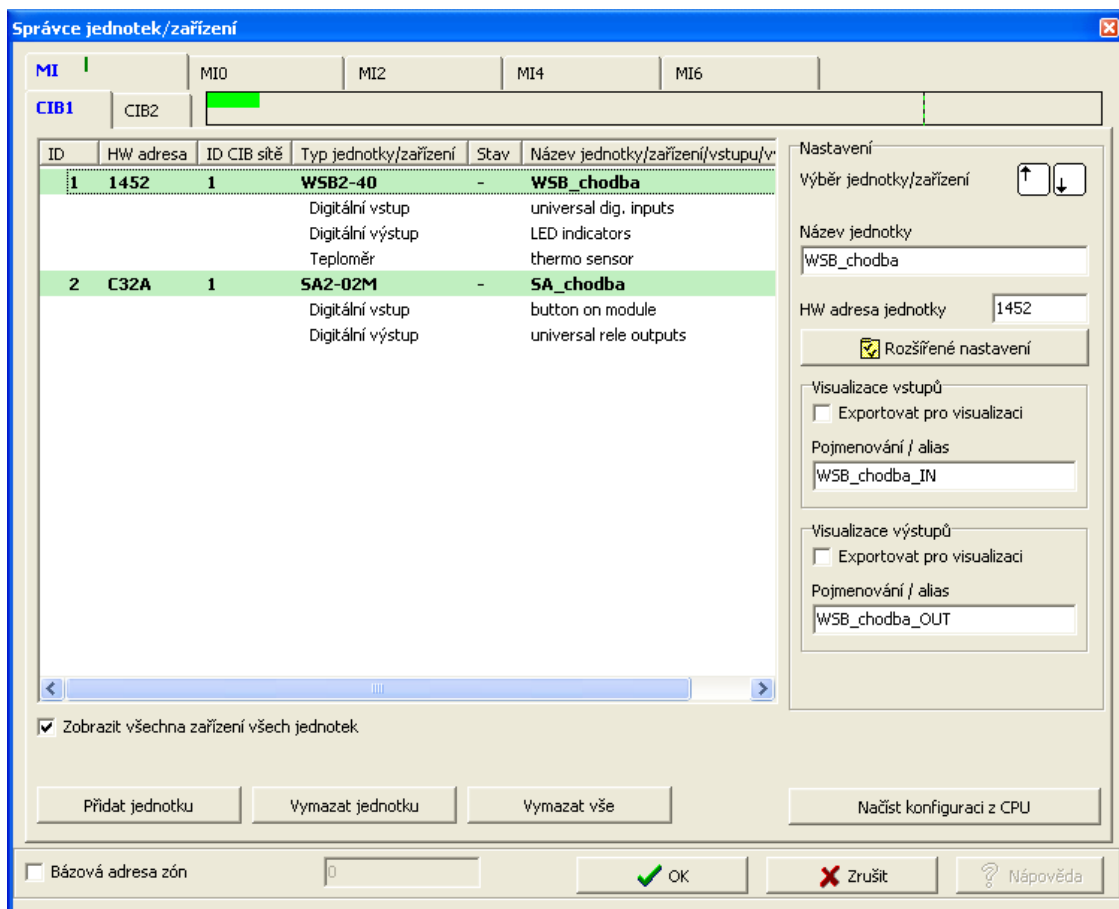

Fig. 2.10 SW configuration of the CIB master

CIB modules can be added on the list manually by the button *Add the unit*, or automatically by the button *Read the configuration from CPU*. Remove module by the button *Delete unit*. Removing all modules can be done by button *Delete all*. Then it shows

2.1. Master configuration

the option to remove all units from the actual CIB line, from the current CIB master or all units from all masters.

At the top of the window right next to the name of the line of selected CIB master is a colour bar graph indicating the usage of memory of the respective CIB lines. If the bar is green the memory capacity for the line is sufficient. If the bar changes the colour for yellow, the memory capacity is near to the limit. It is warning status. If the bar changes the colour for red, the memory capacity is overflow. In such case the line is not able to serve requirements of CIB modules on the line and some module has to be removed from CIB line.

Bar graphs next to the names of individual masters display only to the occupation of the CIB line, disregarding the memory capacity of the line (graph is still green).

HW address of CIB module

Fix address is assigned to the module during the manufacturing process and is written on the cover of the module. CIB address is 4-digit code in hexadecimal format. On the same CIB line cannot be more units with the same HW address!!!! HW address 0000 is dedicated one. (It is excluded from the CIB services). Assignment of the address 0000 is used for temporary withdrawal unit from service of CIB master (while the I/O unit variables stay kept in the structure of the master CIB).

Name of the module

It is possible to enter user identification of the module. Entered text will be used as prefix of the structured data of the module.

Advanced settings

For modules which allows extended user configuration button *Advanced settings* is available. Press the button to activate the dialog offering other properties of the module.

Naming / alias

You can specify a symbolic name under which structure of inputs/outputs of the module will be available in the user program and also in the visualization (SCADA) environment.

Export for visualisation

When checking the item - data structure will be included in the export public file used as input file for visualization software.

In terms of service each CIB module is divided into devices (input, output, digital, analogue,) and the device is further divided into specific inputs / outputs (digital input, digital output, analog input,).

Show all devices of all modules

Checking item the tree branch units of equipment will be unpacked. Checking box **Use device** of the optional device enables to activate or deactivate it.

Base address of the zone

Checking the item enables to enter the absolute position of the beginning of the CIB line in the stack.

2.2. The structure of the transmitted data

CIB master reserves data area in the stack of CPU in which the data transmitted from/to, status and fault zone CIB modules are available. Structure of the data area is evident from panel *Setting I/O* in Mosaic environment. Panel is available after pressing icon  in toolbar.

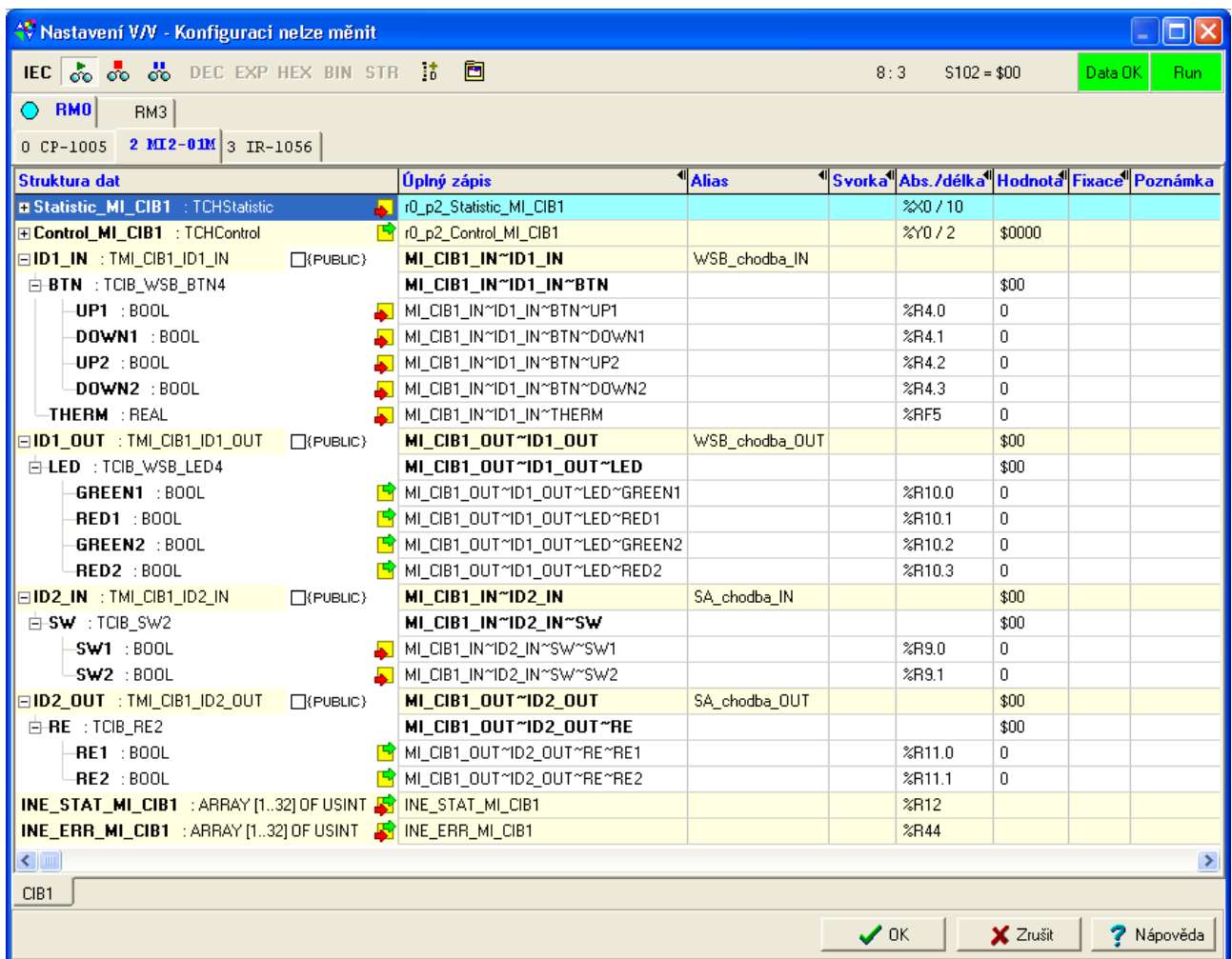

Struktura dat	Úplný zápis	Alias	Svorka	Abs./délka	Hodnota	Fixace	Poznámka
Statistic_MI_CIB1 : TCHStatistic	r0_p2_Statistic_MI_CIB1			%X0 / 10			
Control_MI_CIB1 : TCHControl	r0_p2_Control_MI_CIB1			%Y0 / 2	\$0000		
ID1_IN : TMI_CIB1_ID1_IN <input type="checkbox"/> (PUBLIC)	MI_CIB1_IN~ID1_IN	WSB_chodba_IN					
BTN : TCIB_WSB_BTN4	MI_CIB1_IN~ID1_IN~BTN				\$00		
UP1 : BOOL	MI_CIB1_IN~ID1_IN~BTN~UP1			%R4.0	0		
DOWN1 : BOOL	MI_CIB1_IN~ID1_IN~BTN~DOWN1			%R4.1	0		
UP2 : BOOL	MI_CIB1_IN~ID1_IN~BTN~UP2			%R4.2	0		
DOWN2 : BOOL	MI_CIB1_IN~ID1_IN~BTN~DOWN2			%R4.3	0		
THERM : REAL	MI_CIB1_IN~ID1_IN~THERM			%RF5	0		
ID1_OUT : TMI_CIB1_ID1_OUT <input type="checkbox"/> (PUBLIC)	MI_CIB1_OUT~ID1_OUT	WSB_chodba_OUT			\$00		
LED : TCIB_WSB_LED4	MI_CIB1_OUT~ID1_OUT~LED				\$00		
GREEN1 : BOOL	MI_CIB1_OUT~ID1_OUT~LED~GREEN1			%R10.0	0		
RED1 : BOOL	MI_CIB1_OUT~ID1_OUT~LED~RED1			%R10.1	0		
GREEN2 : BOOL	MI_CIB1_OUT~ID1_OUT~LED~GREEN2			%R10.2	0		
RED2 : BOOL	MI_CIB1_OUT~ID1_OUT~LED~RED2			%R10.3	0		
ID2_IN : TMI_CIB1_ID2_IN <input type="checkbox"/> (PUBLIC)	MI_CIB1_IN~ID2_IN	SA_chodba_IN			\$00		
SW : TCIB_SW2	MI_CIB1_IN~ID2_IN~SW				\$00		
SW1 : BOOL	MI_CIB1_IN~ID2_IN~SW~SW1			%R9.0	0		
SW2 : BOOL	MI_CIB1_IN~ID2_IN~SW~SW2			%R9.1	0		
ID2_OUT : TMI_CIB1_ID2_OUT <input type="checkbox"/> (PUBLIC)	MI_CIB1_OUT~ID2_OUT	SA_chodba_OUT			\$00		
RE : TCIB_RE2	MI_CIB1_OUT~ID2_OUT~RE				\$00		
RE1 : BOOL	MI_CIB1_OUT~ID2_OUT~RE~RE1			%R11.0	0		
RE2 : BOOL	MI_CIB1_OUT~ID2_OUT~RE~RE2			%R11.1	0		
INE_STAT_MI_CIB1 : ARRAY [1..32] OF USINT	INE_STAT_MI_CIB1			%R12			
INE_ERR_MI_CIB1 : ARRAY [1..32] OF USINT	INE_ERR_MI_CIB1			%R44			

Fig. 2.11 The structure of the transmitted data

Mix_CIBx_IN [], Mix_CIBx_OUT []

Zone of input data *Mix_CIBx_IN []* and zone of output data *Mix_CIBx_OUT []* is structured into items *IDx_IN* and *IDx_OUT* in the same order as the CIB modules are inserted during the configuration of the CIB line.

2.2. The structure of the transmitted data

Data are available for the user program either under the automatically generated variable names (column *Full entry*), or under the user name assigned in the *Unit/Device manager* during configuration (column *Alias*).

Before transmission to/from the bus CIB some input/output data are automatically converted to/from other format for efficient transmission over the CIB bus, but in the stack they are accessible in the normal format.

INE_STAT_Mlx_CIBx []

Status zone *INE_STAT_Mlx_CIBx[]* contains the communication status of each CIB module.

	NET	-	-	REI	HS	ADR	COM	INI
Bit	7	6	5	4	3	2	1	0

- INI - unit initialization status
1 - unit is initialized
0 - unit is not initialized
- COM - unit communication status
1 - unit communicates
0 - unit does not communicate
- ADR - unit addressing status
1 - unit addressed successfully
0 - unit is not addressed
- REI - unit reinitialization status (after communication failure)
1 - unit is reinitializing
0 - unit is running
- NET - unit service status
1 - unit is serviced
0 - unit is not serviced
- HS - service signature (for diagnostic purposes)

INE_ERR_Mlx_CIBx []

Fault zone *INE_ERR_Mlx_CIBx[]* indicates the number of failed communications with each CIB units. If the relevant variable contains zero value, the communication with the unit is OK (without communication failure). *INE_ERR_Mlx_CIBx* variables are of type byte, so the number of errors is counted until the value 255, then the counter will rollover to a new error counting from the value 0.

2.3. Power CIB bus

CIB bus has to be powered for the proper operation. Bus power supply can be provided internally directly from CIB master modules, or external power supply is required (see next Tab. below).

For backup power of CIB bus the switching power supply **is recommended: PS2-60/27** (27.2V DC, 60W, designed to recharge batteries). For not backup power of CIB buses it is possible to use switching power supply **DR-60-24** (24V DC, 60W). In the case of external power CIB bus options for proper operation is always **necessary** so separate the impedance of the power supply from the CIB bus by decoupling module C-BS-0001M or BPS2-02M. In the case of internal power CIB bus (e.g. from CF-1141 master module, or from CP-1000/1001 basic module) it is not necessary any additional decoupling. Decoupling is provided directly by these modules.

Module C-BS-0001 provides decoupling of the power supply for one CIB line.

Module BPS2-002M provides decoupling of the power supply for two CIB lines. On the module there is also available direct output voltage to supply the CPU and its peripherals. The module also allows connecting and charging the backup battery that can power both the CPU and CIB lines in case of failure of main power line.

Tab. 2.6 Number of CIB lines in CPU Foxtrot and their power supply

	CP-1000 ¹	CP-1004 ⁴ CP-1005 ³ CP-1006 ² CP-1008 ²	CP-1014 ⁴ CP-1015 ³ CP-1016 ² CP-1018 ²	CP-1020 ¹	CP-1026 ² CP-1028 ²	CP-1036 ² CP-1038 ²
CIB Bus - internal lines	2	1	1	2	1	1
- more lines ⁵ by the external modules MI2-02M ³ and CF-1141 ¹	8					

¹ Modules provide **full** internal power of CIB lines from the master (max. load 1A on each CIB line), external power for CIB lines is not required.

² Modules provide **partial** power CIB lines from internal master for load up to 100mA. For higher load it is necessary to use additional power over the decoupling module.

³ Modules **do not contain** internal power supply of CIB lines. It is always necessary to use an external power supply connected over the decoupling module.

⁴ Modules with internal master CF-1140 (models of year 2011 and later) include partial power lines from the CIB Master for internal consumption up to 100mA. For higher loads is necessary to use an external power supply connected over decoupling module.

Modules with internal master MI2-01M (models before year 2010) do not contain any internal power of CIB lines. It is always necessary to use an external power supply connected over the decoupling module.

⁵ The total number of connected CIB lines and RFox networks interact. Total number of modules CF-1141, MI2-02M and RF-1131 can be max. 4.

2.3. Power CIB bus

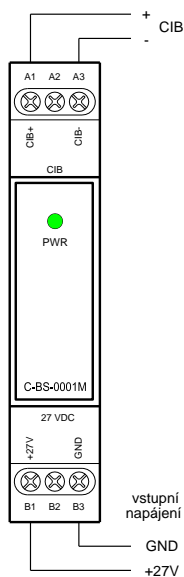

Fig. 2.12 Connection example C-BS-0001M

Tab. 2.7 Basic parameters C-BS-0001M

Power supply	
Input voltage	24 ÷ 27,2V DC
Output voltage for CIB	1x 24 ÷ 27,2V DC / 1A
Dimensions and weight	
Dimensions	90 × 18 × 60mm
Weight	120g
Operating and installation conditions	
Operating temperature	0 ÷ +70 °C
Storage temperature	-25 ÷ +85 °C
Electrical strength	according to EN 60950
IP degree of protection acc. IEC 529	IP 20
Overvoltage category	III
Degree of pollution according EN 61131-2	2
Operating position	arbitrary
Installation	on DIN rail
Connecting	screw type terminals
Cross-section of wires	max. 2,5 mm ²

Tab. 2.8 Basic parameters BPS2-02M

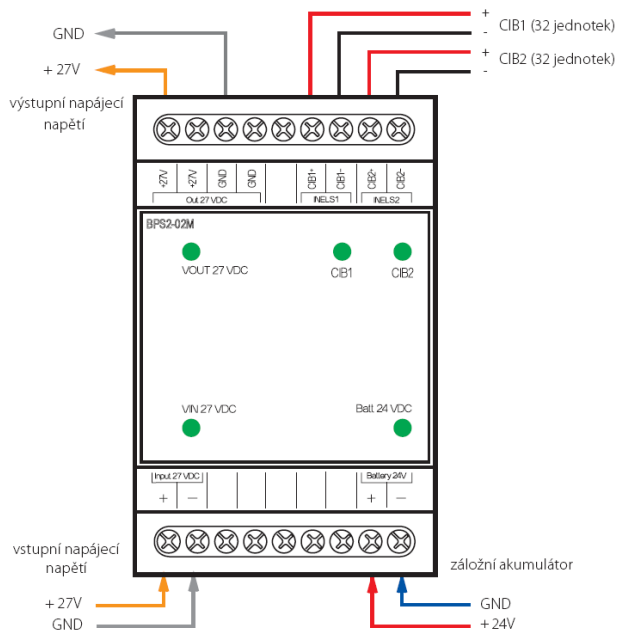

Fig. 2.13 Connection example of BPS2-02M

Power supply	
Input voltage	24 ÷ 27,2V DC
Output voltage for CIB	2x 24 ÷ 27,2V DC / 1A
Output voltage CPU	24 ÷ 27,2V DC / 1A
Input for AKU	24V (2x 12V in series)
The charging current AKU	2A
Dimensions and weight	
Dimensions	90 × 52 × 65mm
Weight	100g
Operating and installation conditions	
Operating temperature	-20 ÷ +55 °C
Storage temperature	-30 ÷ +70 °C
Electrical strength	according to EN 60950
IP degree of protection acc. IEC 529	IP 20
Overvoltage category	III
Degree of pollution according EN 61131-2	2
Operating position	arbitrary
Installation	on DIN rail
Connecting	screw type terminals
Cross-section of wires	max. 2,5 mm ²

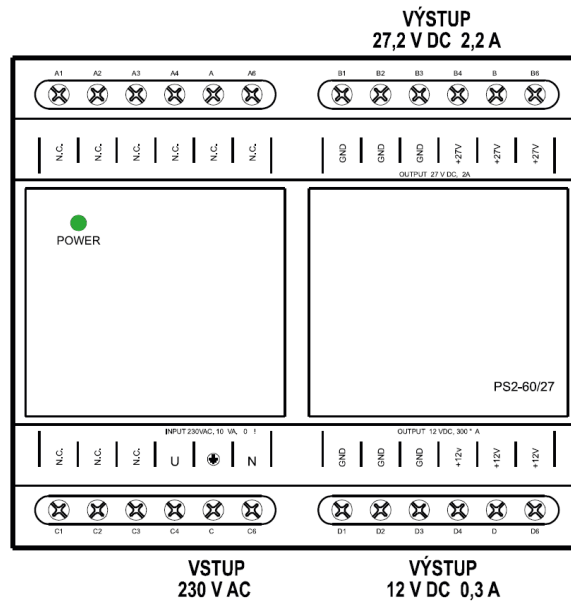



Fig. 2.14 View of PS2-60/27

Tab. 2.9 Basic parameters PS2-60/27

Power input	
Input voltage	230V AC; +15/-25 %
Minimum input voltage	110V AC at reduced power to 45 W
Input voltage frequency	47–63 Hz
Maximum power consumption	106 VA
Input protection	T2,5/250V

Power outputs	
Number of voltage levels	2
Output voltage / current of 1st level	27,2 V DC/ 0 ÷ 2,2 A
Output voltage/current of the 2nd level	12 V DC/ 0 ÷ 0,3 A
Total output power	max. 60W
Protection against short circuit	electronic
Efficiency	87%
Dimensions and weight	
Dimensions	105 × 90 × 65mm
Weight	340g
Operating and installation conditions	
Operating temperature	–10 ÷ +60 °C
Storage temperature	–40 ÷ +85 °C
Air relative humidity	20 ÷ 90% without condensation
Electrical strength	according to EN 60950
Protection class of appliance	I according to EN 61140
Degree of ingress protection EN 60529	IP 20, IP40 covered in the switchboard
Overvoltage category EN 60664-1	II
Degree of pollution EN 60664-1	2
Operating position	vertical
Installation	on DIN rail in switchboard
Connecting	screw type terminals
Cross-section of wires	max. 2,5 mm ²

3. CIB UNITS, MODULES

This chapter describes the parameters CIB units, examples of their connection, configuration procedure and description of the structures of data transmitted by units. Dialogs of unit configuration are available from the window *Unit/device manager* after pressing button  *Advanced settings*.

Structures of transmitted data can be seen in the window *I/O setting* in Mosaic, see. fig. 2.4 Panel is available by clicking on the icon  in the toolbar.

Structure items have assigned symbolic names that begin always by characters *IDx_IN* and *IDx_OUT*, where x is number corresponding to the order of unit on the bus (column ID in *Unit/device manager*). In the column *Full notation* is always present concrete symbolic name for that item. If we want to use data in the user program we use either this symbolic name or we enter our own symbolic name that can then be used into the column *Alias*. We do not use absolute operands in any case since they can be changed after next compilation of the user program.

CIB modules of INELS II manufactured by ELKO EP s.r.o. Holešov, that can be connected to the CIB bus, are described in separate manual *Peripheral modules INELS II on CIB bus (TXV 004 17)*.

ELKO EP, INELS and iNELS are registered trademarks of Elko EP s.r.o. Holešov.

3.1. C-AM-0600I

Measuring module contains five universal inputs and 1 interface for connecting the flow meter Taconova AV23. Universal inputs can be configured for measuring resistive temperature sensors, voltage and current or as binary inputs or as an input interface for counting pulses from energy meters (standard interface S0 according to IEC 61393 / DIN 43864). Interface for connecting a flow meter Taconova AV23 includes two measuring inputs, one for the evaluation of the flow and one for evaluating the temperature of the reference medium.

The module is housed in a plastic box with increased protection IP55, for installation on the wall or on the cover of the device or panel.

Under the plastic cover of the module is placed LED indicator. After connecting the module to the CIB line (power connected) the green RUN LED lights still. If the module is served by the CIB (it communicates), green RUN LED flashes regularly.

3.1. C-AM-0600I

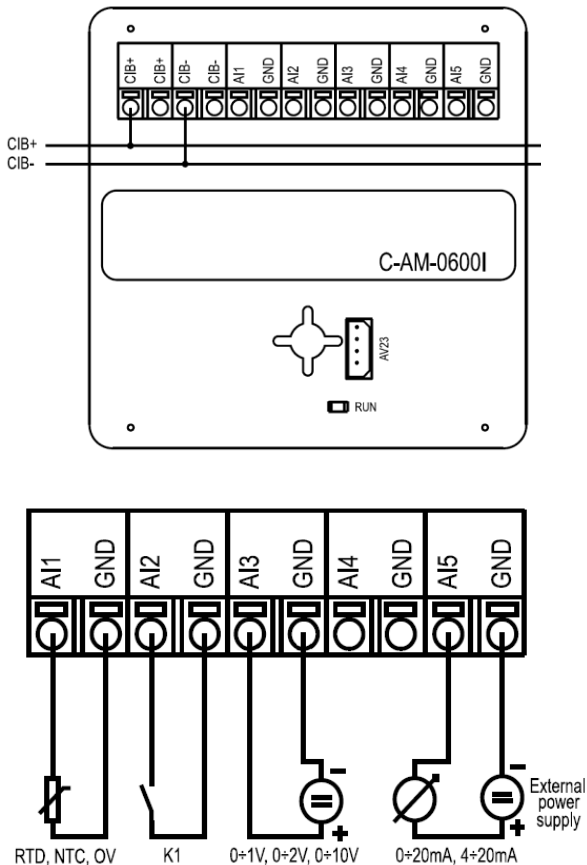

Fig. 3. 1 View and connecting C-AM-0600I

Interface for flow meter Taconova AV23	
Supply voltage	5V DC
Typical power consumption from CIB	3mA
Input resistance	>14kΩ
Range of measurement	0.5 ÷ 3.5V ~ 1 ÷ 12 l/min, ~ 2 ÷ 40 l/min, ~ 0 ÷ 100 °C
Measurement error	±0.5%

Power supply	
Power supply and communication	24 V (27 V) from the CIB
Max. power consumption	80mA
Dimensions and weight	
Dimensions	104 × 85 × 37mm
Weight	65 g

1) For resistors over 50kΩ the resolution of AD converter decreases considerably thus increasing measurement error. These ranges are only complementary.

2) Range OV450k can only be set on input AI5.

3) Binary inputs do not have their own configuration dialog. They are set by the configuration dialog of the corresponding analog input.

4) Active binary input corresponds to the range of 0 ÷ 10V. Passive binary input corresponds to ranges Pt1000, Ni1000, KTY81-121.

5) Input AI5 as pulse counter has to use reduced voltage that does not meet the standard interface S0.

3.1.1. Configuration

Tab. 3.1 Basic parameters C-AM-0600I

Universal inputs	
Quantity	5
Optional input type	analog, binary, pulse counter
- Analog	
Resistance ranges	Pt1000 (−90 ÷ +320 °C), Ni1000 (−60 ÷ +200 °C), NTC12k (−40 ÷ +125 °C), KTY81-121 (−55 ÷ +125 °C), OV200k (0 ÷ 200kΩ), OV450k (0 ÷ 450kΩ)
Voltage ranges	0 ÷ 10V, 0 ÷ 2V, 0 ÷ 1V
Current ranges	0 ÷ 20mA, 4 ÷ 20mA
Accuracy	±0.5% of full range, ±1% (NTC12k), ±10% (OV200k,OV450k) ¹⁾²⁾
Period of refresh AI	typically 5s
- Binary ³⁾	
Delay log.0 -> log.1	10ms
Delay log.1 -> log.0	500ms
Minimal pulse width	30ms
Type of binary input ⁴⁾	Active or passive
- Passive Input voltage	7.4V from internal power supply
- Active Input resistance	64.9kΩ
- Pulse counter (standard interface S0, IEC 61393)	
Reference voltage typ.	24V DC for AI1 ÷ AI4, 7.4V for AI5 ⁵⁾
Max. input current	14mA
Min. pulse width	30ms
Max. pulse frequency	20Hz
Max. switch resistance	800Ω in closed state
Operating and installation conditions	
Operating temperature	−10 ÷ +55 °C
Storage temperature	−25 ÷ +70 °C
IP degree of protection acc. IEC 529	IP55
Operating position	arbitrary
Type of operation	continuous
Installation	
Type	wall (surface) mounting
Connecting	Push-in terminals, AV23 connector
Cross-section of wires	0.14 ÷ 1.5 mm ²

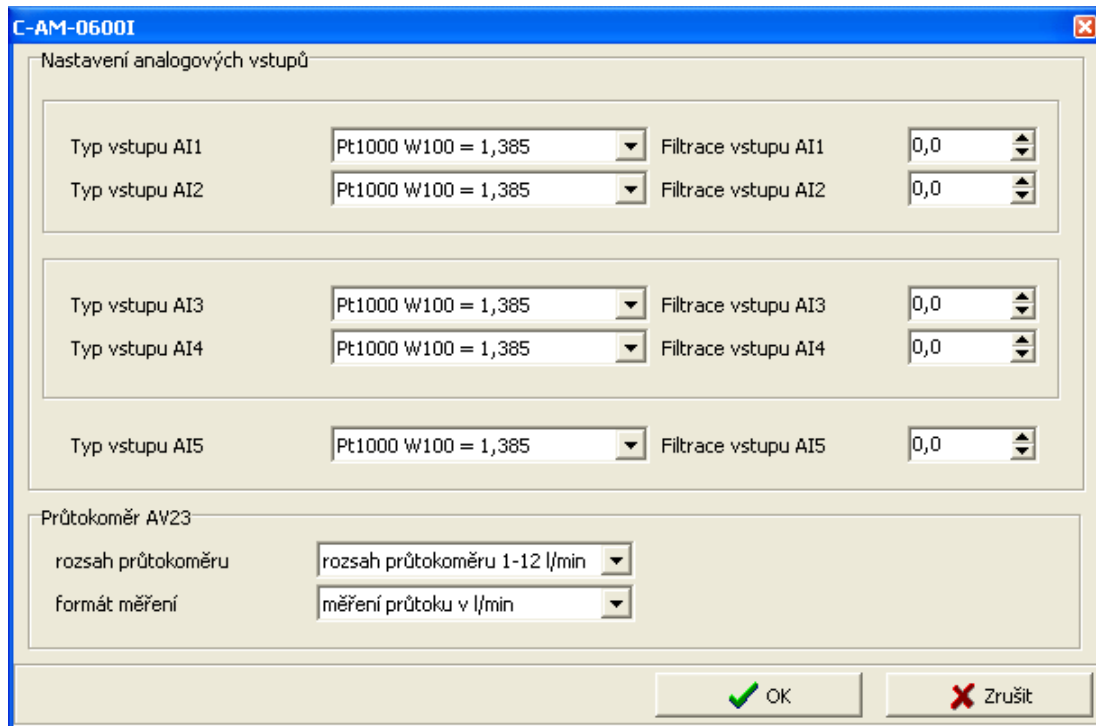

Fig. 3.2 Module configuration

Input terminals of the module are **shared**, for more functions of inputs (devices). Depending on the configured input (as enabled devices) specific items of configuration dialog are enabled/disabled. Enabling devices see. chap.2.1 *Master configuration*, check the box *Show units, devices*

Type of input

Choosing the type of analog input:

- Pt1000, $W_{100} = 1,385$, $-90/+320^{\circ}\text{C}$
- Pt1000, $W_{100} = 1,391$, $-90/+320^{\circ}\text{C}$
- Ni1000, $W_{100} = 1,617$, $-60/+200^{\circ}\text{C}$
- Ni1000, $W_{100} = 1,500$, $-60/+200^{\circ}\text{C}$
- NTC 12k (negative thermistor, $12\text{k}\Omega$ at 25°C), $-40/+125^{\circ}\text{C}$
- KTY 81-121, $-55/+125^{\circ}\text{C}$
- $0 \div 10\text{V}$
- $0 \div 2\text{V}$
- $0 \div 1\text{V}$
- $0 \div 20\text{mA}$
- $4 \div 20\text{mA}$
- OV200k ($0 \div 200\text{k}\Omega$)
- OV450k ($0 \div 450\text{k}\Omega$)
- 16-bit pulse counter, S0

Input filtering

By specifying a non-zero value of the time constant, the 1st order digital filter is activated. The filter is given by

$$y_t = \frac{y_{t-1} \cdot \tau + x}{\tau + 1}$$

- x - the current value of the analog input
- y_t - output
- y_{t-1} - recent output
- τ -time constant of the 1st order filter (TAU)

Value of time constant is set in the range $0.1 \div 25.4$ and it represents a time constant in the range of $100 \text{ ms} \div 25.4 \text{ s}$ (value 255 is intended for service purposes).

Range of flow meter

Range selection of the connected flowmeter Taconova AV23:

- 1 \div 12 l/min
- 2 \div 40 l/min

Measurements format

Choosing the format in which the data from the flow meter Taconova AV23 will be presented:

- l/min
- m^3/h
- dm^3/h

3.1.1. The structure of the transmitted data

The module contains a total of six devices, each of them can be individually activated / deactivated

- device 1, input, 1*STAT (status of analog AI)
- device 2, input, 2*AI (input AI1, AI2)
- device 3, input, 2*AI (input AI3, AI4)
- device 4, input, 1*AI (input AI5)
- device 5, input, 2*AI (flow meter AV23)
- device 6, input, 5*DI (binary inputs)

The devices are incorporated into the structure of the transmitted data, which is evident from window *I/O setting* in the Mosaic. Window is accessible by pressing the icon  in toolbar.

CIB UNITS, MODULES

Struktura dat	Úplný zápis	Alias	Svorka	Abs./délka	Hodnota
[-] ID1_IN : TMI_CIB1_ID1_IN	MI_CIB1_IN~ID1_IN				
[-] STAT : TCIB_CAM0600I_STAT	MI_CIB1_IN~ID1_IN~STAT			%R4 / 2	
AI1 : REAL	MI_CIB1_IN~ID1_IN~AI1			%RF6	
AI2 : REAL	MI_CIB1_IN~ID1_IN~AI2			%RF10	
AI3 : REAL	MI_CIB1_IN~ID1_IN~AI3			%RF14	
AI4 : REAL	MI_CIB1_IN~ID1_IN~AI4			%RF18	
AI5 : REAL	MI_CIB1_IN~ID1_IN~AI5			%RF22	
[-] AV23 : TCIB_CAM06600I_AV23	MI_CIB1_IN~ID1_IN~AV23				
FLOW : REAL	MI_CIB1_IN~ID1_IN~AV23~FLOW			%RF26	
THERM : REAL	MI_CIB1_IN~ID1_IN~AV23~THERM			%RF30	
[-] DI : TCIB_DI5	MI_CIB1_IN~ID1_IN~DI				
DI1 : BOOL	MI_CIB1_IN~ID1_IN~DI~DI1			%R34.0	
DI2 : BOOL	MI_CIB1_IN~ID1_IN~DI~DI2			%R34.1	
DI3 : BOOL	MI_CIB1_IN~ID1_IN~DI~DI3			%R34.2	
DI4 : BOOL	MI_CIB1_IN~ID1_IN~DI~DI4			%R34.3	
DI5 : BOOL	MI_CIB1_IN~ID1_IN~DI~DI5			%R34.4	

Fig. 3.3 The structure of the transmitted data

Input data

STAT	AI1	AI2	AI3	AI4	AI5	AV23	DI
------	-----	-----	-----	-----	-----	------	----

STAT - status byte of analog inputs (16x type bool)

	VLD4	OUF4	VLD3	OUF3	VLD2	OUF2	VLD1	OUF1
Bit	.7	.6	.5	.4	.3	.2	.1	.0
	-	-	VLD6b	OUF6b	VLD6a	OUF6a	VLD5	OUF5
Bit	.15	.14	.13	.12	.11	.10	.9	.8

OUFx - overflow / underflow of analog input AIx

VLDx - validity of reading of analog input AIx

OUF6a- overflow / underflow of range of flow meter FLOW

VLD6a - validity of reading the flow meter FLOW

OUF6b - overflow / underflow of range of thermometer THERM

VLD6b - validity of reading the thermometer THERM

AIx - value of analog input AIx, number of pulses of counter (type real) [°C], [kΩ], [mV], [mA], [pulses]

AV23.FLOW - media flow of flow meter AV23 (type real) [l/min, m³/h, dm³/h]

AV23.THERM - media temperature of flow meter AV23 (type real) [°C]

DI - status of binary inputs (8x type bool)

	-	-	-	DI5	DI4	DI3	DI2	DI1
Bit	.7	.6	.5	.4	.3	.2	.1	.0

DIx - status of binary input DIx

3.2. C-AQ-0001R

Module for interior mounting for measuring the concentration of carbon dioxide CO₂ in the air. The module contains a dual channel measurement system using optical attenuation of infrared radiation, depending on the concentration of CO₂ in the air (based on NDIR - NonDispersive InfraRed sensor). The module allows to perform automatic calibration, which ensures long life and stability of the sensor. The module contains a auxiliary temperature sensor (measuring the temperature inside the module does not correspond to the ambient temperature module!!!).

Mechanical design of the module allows easy wall mounting.

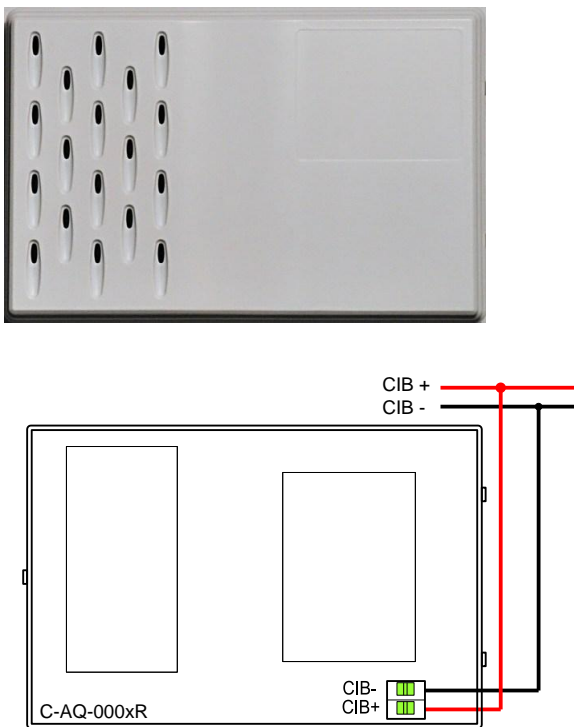

Fig. 3. 4 View and connecting C-AQ-0001R

3.2.1. Configuration

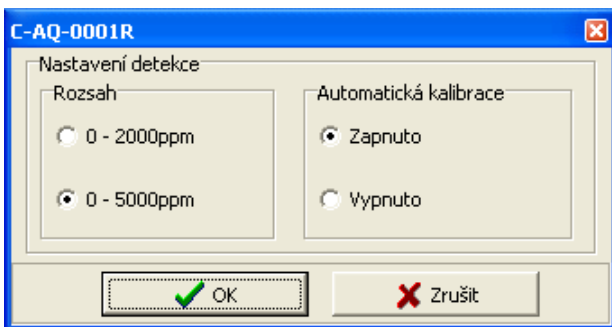

Fig. 3.5 Module configuration

Tab. 3.2 Basic parameters C-AQ-0001R

Measuring input CO₂	
The selectable ranges	300 ÷ 2000 ppm 300 ÷ 5000 ppm
Sensor warming after switch on	2 min
Resolution	1 ppm
Accuracy	50 ppm (1%)
Long term stability	50 ppm / year
Influence of the pressure	1,6 % / kPa
Operating humidity	max. 95 % non condensed
Calibration	From the factory + automatic
The lifetime of a measuring sensor	Typ. 10 years
auxiliary temperature input	
Sensor type	Thermistor NTC 12k, internal
Range	0 ÷ +50 °C
Accuracy	0,8 °C
Power supply	
Power supply and communication	24 V (27 V) from the CIB
Nominal power consumption	90 mA
Dimensions and weight	
Dimensions	125 × 83 × 36mm
Weight	300g
Operating and installation conditions	
Operating temperature	0 ÷ +40 °C
Storage temperature	-20 ÷ +60 °C
IP degree of protection acc. IEC 529	IP20
Overvoltage category	III
Degree of pollution according EN 61313	2
Operating position	arbitrary
Installation	on the wall
Connecting	screw type terminals
Cross-section of wires	max. 2,5 mm ²

Range

Setting the range of measuring sensor. You can choose between a range of 300÷2000ppm and 300÷5000ppm.

Automatic calibration

Checking the item *On* the module will perform regular automatic calibration of the measuring sensor during the operation.

3.2.2. The structure of the transmitted data

Module contains 3 devices in total:

- device 1, input, 1*STAT (status)
- device 2, input, 1*AI (CO2)
- device 3, input, 1*AI (internal thermometer)

The devices are incorporated into the structure of the transmitted data, which is evident from window *I/O setting* in the Mosaic. Window is accessible by pressing the icon  in toolbar.

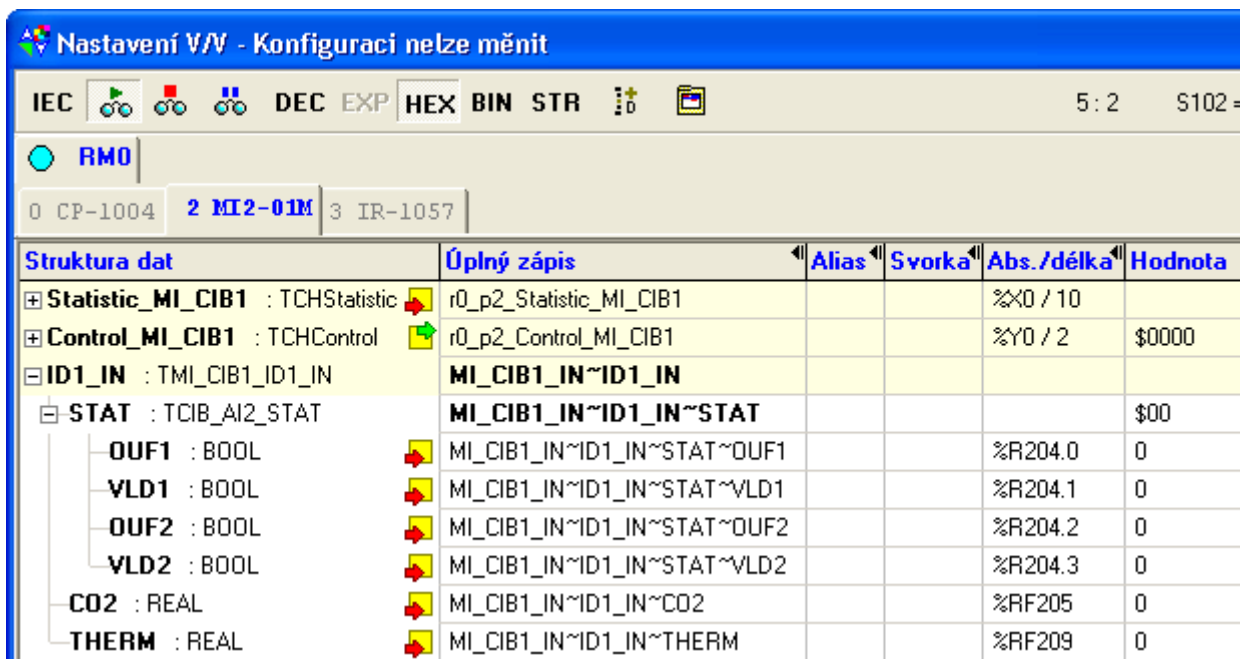

Fig. 3.6 The structure of the transmitted data

Input data

STAT	CO2	THERM
------	-----	-------

STAT - status byte of analog inputs (8x type bool)

	-	-	-	-	VLD2	OUF2	VLD1	OUF1
Bit	.7	.6	.5	.4	.3	.2	.1	.0

OUF1 - overflow of concentration of CO₂

3.2. C-AQ-0001R

VLD1 - validity of reading of concentration of CO₂
OUF2 - overflow / underflow of range of thermometer THERM
VLD2 - validity of reading the thermometer THERM

CO₂ - concentration CO₂ (type real) [ppm] (1ppm = 1part per million)

THERM - temperature of auxiliary internal sensor (type real) [°C]

3.3. C-AQ-0002R

Module for interior for measuring the presence of volatile gaseous pollutants (VOC - Volatile Organic Compounds) in the air. The detection is based on the electrochemical principle (conductivity measurement by selective semiconductor sensor). The module is particularly sensitive to toluene, hydrogen sulphide, ethanol, ammonia and hydrogen. In addition, you can also detect alcohol vapour, methane, propane, butane, natural gas and substances released from building materials, interior equipment. The module contains an auxiliary temperature sensor (measuring the temperature inside the module does not correspond to the ambient temperature module!!!).

Mechanical design of the module allows easy wall mounting.

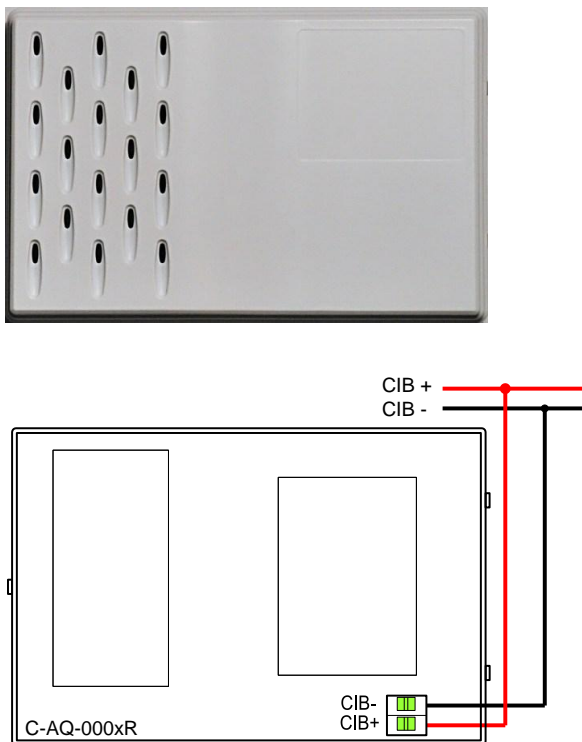

Fig. 3. 7 View and connection C-AQ-0002R

3.3.1. Configuration

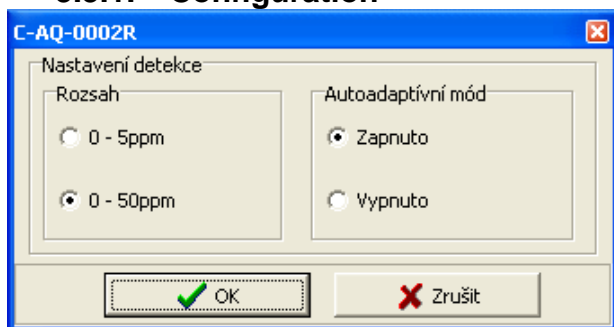

Fig. 3.8 Module configuration

Tab. 3.3 Basic parameters C-AQ-0002R

VOC measuring input	
The selectable ranges	0 ÷ 5 ppm 0 ÷ 50 ppm
Sensor warming after switch on	10 min
auxiliary temperature input	
Sensor type	Thermistor NTC 12k, internal
Range	0 ÷ +50 °C
Resolution	0,1 °C
Accuracy	0,8 °C
Power supply	
Power supply and communication	24 V (27 V) from the CIB
Nominal power consumption	80 mA
Dimensions and weight	
Dimensions	125 × 83 × 36mm
Weight	300g
Operating and installation conditions	
Operating temperature	0 ÷ +40 °C
Storage temperature	-20 ÷ +60 °C
IP degree of protection acc. IEC 529	IP20
Overvoltage category	III
Degree of pollution according EN 61313	2
Operating position	arbitrary
Installation	on the wall
Connecting	screw type terminals
Cross-section of wires	max. 2,5 mm ²

Range

Selectable ranges. It is possible to select 0÷5ppm and 0÷50ppm.

Auto adaptive mode

Check box *On* the module will perform regular automatic adaptation of the measuring sensor.

3.3.2. The structure of the transmitted data

Module contains 3 devices in total:

- device 1, input, 1*STAT (status)
- device 2, input, 1*AI (VOC)
- device 3, input, 1*AI (internal temperature)

The devices are incorporated into the structure of the transmitted data, which is evident from window *I/O setting* in the Mosaic. Window is accessible by pressing the icon  in toolbar.

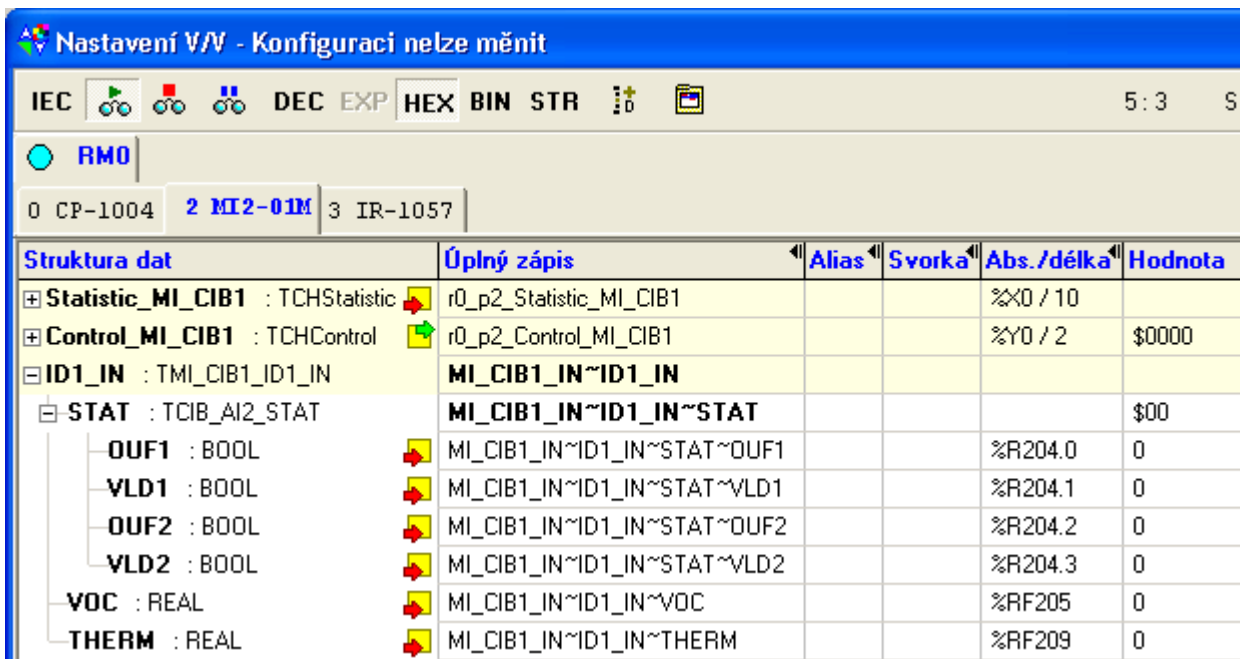

Fig. 3.9 The structure of the transmitted data

Input data

STAT	VOC	THERM
------	-----	-------

STAT - status byte of analog inputs (8x type bool)

	-	-	-	-	VLD2	OUF2	VLD1	OUF1
Bit	.7	.6	.5	.4	.3	.2	.1	.0

OUF1 - overflow of concentration of VOC

CIB UNITS, MODULES

VLD1 - validity of reading of concentration of VOC
OUF2 - overflow / underflow of range of thermometer THERM
VLD2 - validity of reading the thermometer THERM

VOC - value of concentration of VOC (type real) [ppm] (1ppm = 1 part per million)

THERM - temperature of auxiliary internal sensor (type real) [°C]

3.4. C-AQ-0003R

Module for interior for measuring the presence of smoke (carbon monoxide and hydrogen) in the air. The detection is based on the electrochemical principle (conductivity measurement by selective semiconductor sensor). The module can be used for detection of leakage of gases methane, propane, butane and natural gas. The module contains an auxiliary temperature sensor (measuring the temperature inside the module does not correspond to the ambient temperature module!!!).

Mechanical design of the module allows easy wall mounting.

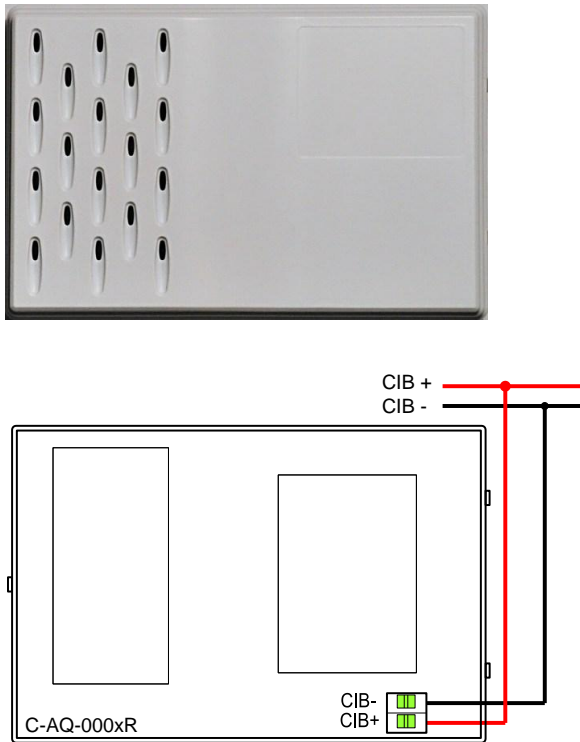

Fig. 3.10 View and connection C-AQ-0003R

3.4.1. Configuration

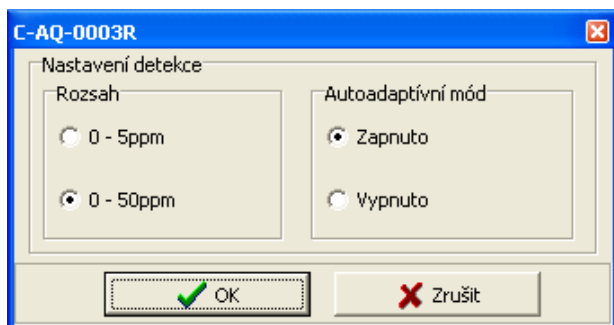

Fig. 3.11 Module configuration

Tab. 3.4 Basic parameters C-AQ-0003R

Smoke measuring input	
The selectable ranges	0 ÷ 5 ppm 0 ÷ 50 ppm
Sensor warming after switch on	10 min
auxiliary temperature input	
Sensor type	Thermistor NTC 12k, internal
Range	0 ÷ +50 °C
Resolution	0,1 °C
Accuracy	0,8 °C
Power supply	
Power supply and communication	24 V (27 V) from the CIB
Nominal power consumption	80 mA
Dimensions and weight	
Dimensions	125 × 83 × 36mm
Weight	300g
Operating and installation conditions	
Operating temperature	0 ÷ +40 °C
Storage temperature	-20 ÷ +60 °C
IP degree of protection acc. IEC 529	IP20
Overvoltage category	III
Degree of pollution according EN 61313	2
Operating position	arbitrary
Installation	on the wall
Connecting	screw type terminals
Cross-section of wires	max. 2,5 mm ²

Range

Setting the range of measuring sensor. You can choose between a range of 0÷5ppm and 0÷50ppm.

Auto adaptive mode

Checking box *On* the module will perform regular automatic adaptation of measuring sensor.

3.4.2. The structure of the transmitted data

Module contains 3 devices in total:

- device 1, input, 1*STAT (status)
- device 2, input, 1*AI (smoke)
- device 3, input, 1*AI (internal thermometer)

The devices are incorporated into the structure of the transmitted data, which is evident from window *I/O setting* in the Mosaic. Window is accessible by pressing the icon  in toolbar.

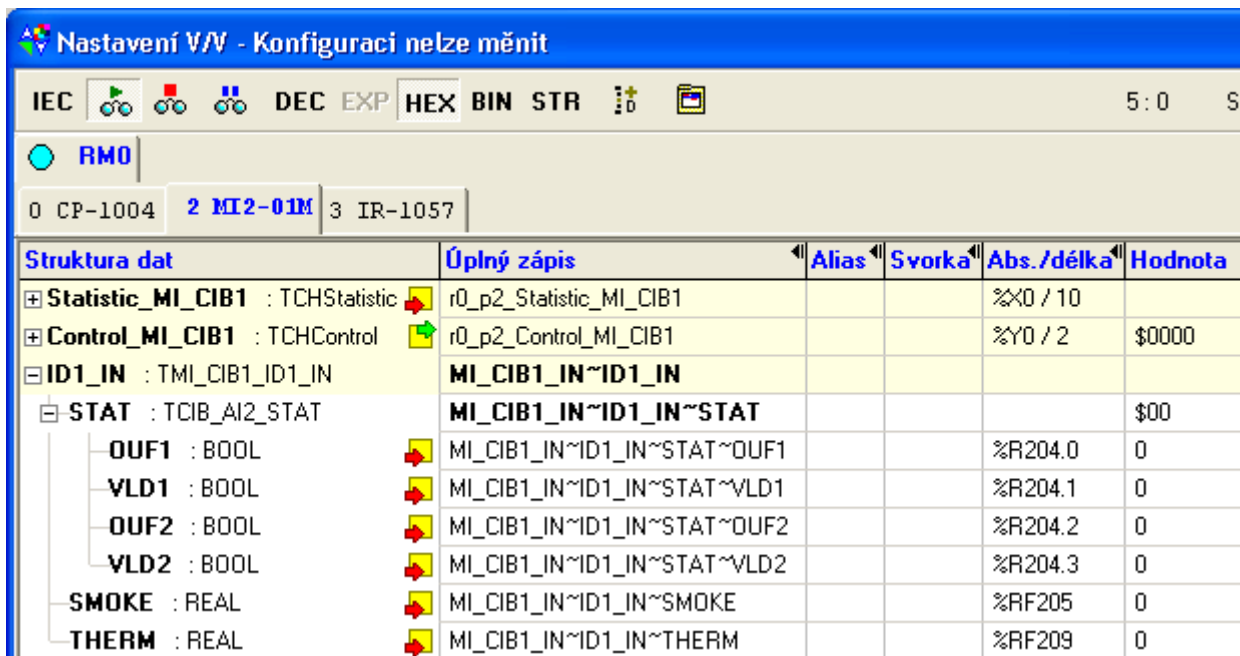

Struktura dat	Úplný zápis	Alias	Svorka	Abs./délka	Hodnota
Statistic_MI_CIB1 : TCHStatistic	r0_p2_Statistic_MI_CIB1			%X0 / 10	
Control_MI_CIB1 : TCHControl	r0_p2_Control_MI_CIB1			%Y0 / 2	\$0000
ID1_IN : TMI_CIB1_ID1_IN	MI_CIB1_IN~ID1_IN				
STAT : TCIB_AI2_STAT	MI_CIB1_IN~ID1_IN~STAT				\$00
OUF1 : BOOL	MI_CIB1_IN~ID1_IN~STAT~OUF1			%R204.0	0
VLD1 : BOOL	MI_CIB1_IN~ID1_IN~STAT~VLD1			%R204.1	0
OUF2 : BOOL	MI_CIB1_IN~ID1_IN~STAT~OUF2			%R204.2	0
VLD2 : BOOL	MI_CIB1_IN~ID1_IN~STAT~VLD2			%R204.3	0
SMOKE : REAL	MI_CIB1_IN~ID1_IN~SMOKE			%RF205	0
THERM : REAL	MI_CIB1_IN~ID1_IN~THERM			%RF209	0

Fig. 3.12 The structure of the transmitted data

Input data

STAT	SMOKE	THERM
------	-------	-------

STAT - status byte of analog inputs (8x type bool)

-	-	-	-	VLD2	OUF2	VLD1	OUF1	
Bit	.7	.6	.5	.4	.3	.2	.1	.0

- OUF1 - overflow of concentration of SMOKE
- VLD1 - validity of reading of concentration of SMOKE
- OUF2 - overflow / underflow of range of thermometer THERM
- VLD2 - validity of reading the thermometer THERM

SMOKE - value of smoke concentration (type real) [ppm] (1ppm = 1 part per million)

THERM - temperature of auxiliary internal sensor (type real) [°C]

3.5. C-AQ-0004R

Module for interior for measuring the relative humidity in the air

Humidity is evaluated by capacitive polymer sensor. The module contains an auxiliary temperature sensor.

Mechanical design of the module allows easy wall mounting.

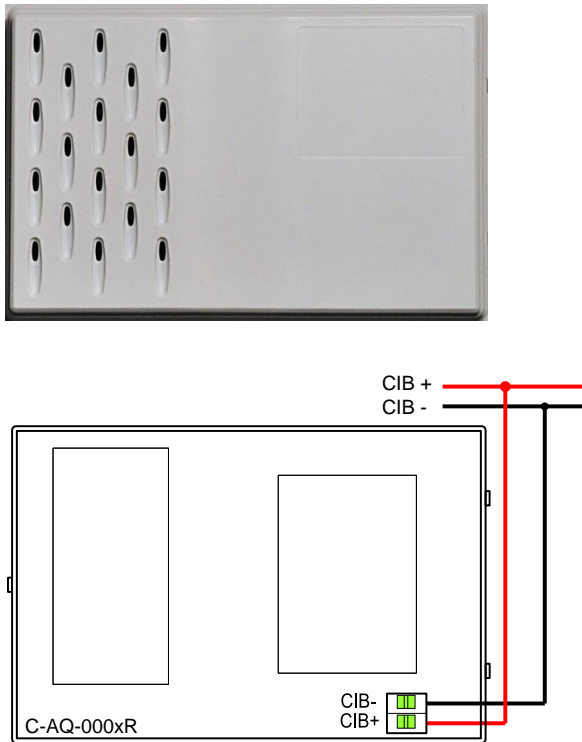

Fig. 3.13 View and connection C-AQ-0004R

Tab. 3.5 Basic parameters C-AQ-0004R

Measuring input RH	
Range	0 ÷ 100 % RH
Resolution	0,1 % RH
Accuracy	3,5 % RH (for RH 20 ÷ 80%) 5 % RH (for RH 0 ÷ 100%)
auxiliary temperature input	
Sensor type	Thermistor NTC 12k, internal
Range	0 ÷ +50 °C
Resolution	0,1 °C
Accuracy	0,8 °C
Power supply	
Power supply and communication	24 V (27 V) from the CIB
Nominal power consumption	42 mA
Dimensions and weight	
Dimensions	125 × 83 × 36mm
Weight	300g
Operating and installation conditions	
Operating temperature	0 ÷ +40 °C
Storage temperature	-20 ÷ +60 °C
IP degree of protection acc. IEC 529	IP20
Overvoltage category	III
Degree of pollution according EN 61313	2
Operating position	arbitrary
Installation	on wall
Connection	screw type terminals
Cross-section of wires	max. 2,5 mm ²

3.5.1. Configuration

The module does not require additional configuration.

3.5.2. The structure of the transmitted data

Module contains 3 devices in total:

- device 1, input, 1*STAT (status)
- device 2, input, 1*AI (humidity)
- device 3, input, 1*AI (internal thermometer)

The devices are incorporated into the structure of the transmitted data, which is evident from window *I/O setting* in the Mosaic. Window is accessible by pressing the icon  in toolbar.

Struktura dat	Úplný zápis	Alias	Svorka	Abs./délka	Hodnota
Statistic_MI_CIB1 : TCHStatistic	r0_p2_Statistic_MI_CIB1			%X0 / 10	
Control_MI_CIB1 : TCHControl	r0_p2_Control_MI_CIB1			%Y0 / 2	\$0000
ID1_IN : TMI_CIB1_ID1_IN	MI_CIB1_IN~ID1_IN				
STAT : TCIB_AI2_STAT	MI_CIB1_IN~ID1_IN~STAT				\$00
OUF1 : BOOL	MI_CIB1_IN~ID1_IN~STAT~OUF1			%R204.0	0
VLD1 : BOOL	MI_CIB1_IN~ID1_IN~STAT~VLD1			%R204.1	0
OUF2 : BOOL	MI_CIB1_IN~ID1_IN~STAT~OUF2			%R204.2	0
VLD2 : BOOL	MI_CIB1_IN~ID1_IN~STAT~VLD2			%R204.3	0
RH : REAL	MI_CIB1_IN~ID1_IN~RH			%RF205	0
THERM : REAL	MI_CIB1_IN~ID1_IN~THERM			%RF209	0

Fig. 3.14 The structure of the transmitted data

Input data

STAT	RH	THERM
------	----	-------

STAT - status byte of analog inputs (8x type bool)

	-	-	-	-	VLD2	OUF2	VLD1	OUF1
Bit	.7	.6	.5	.4	.3	.2	.1	.0

OUF1 - overflow / underflow of RH - relative humidity measuring

VLD1 - validity of reading RH

OUF2 - overflow / underflow of range of thermometer THERM

VLD2- validity of reading the thermometer THERM

RH - value of RH relative humidity (type real) [%]

THERM - temperature of auxiliary internal sensor (type real) [°C]

3.6. C-DL-0012S

The module operates as a converter CIB bus on the bus DALI (according to specification *NEMA Standards Publication 243-2004*). DALI is bus specialized to control DALI lighting modules (ballasts). One converter C-DL-0012S can control up to 12 DALI ballasts. The converter has implemented system support for the "random" addressing the connected DALI ballasts.

The mechanical design of the module is designed to be mounted under cover of device (ingress protection of the module IP10B). Signals of the module are available on ribbon cable.

signalling green RUN LED is accessible from the side of module opposite to ribbon cable. Connecting on the CIB bus (connection to the power supply) is indicated by permanent lit of the RUN LED. Module operation on the CIB is indicated by regular flashing of the RUN LED.

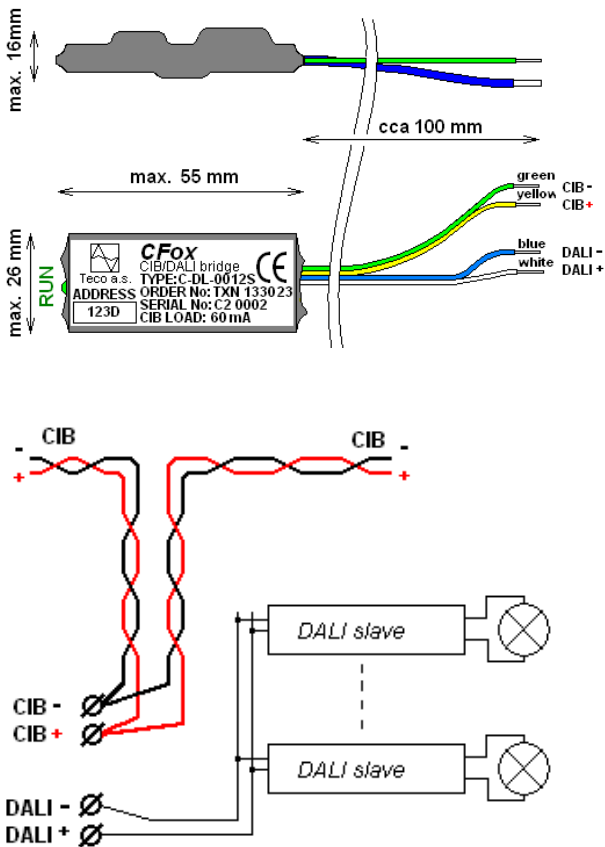

Fig. 3.15 View and connection C-DL-0012S

3.6.1. Configuration

For software support of the module it is necessary library DaliLib.mlb imported in Mosaic. Configuration and serving Dali network is then performed using function blocks of this library. For detailed description of the library see documentation TXV 003 66 Library

Tab. 3.6 Basic parameters C-DL-0012S

DALI	
Number of connected DALI ballast	12
Supported "short addresses" of DALI ballast	0 ÷ 11, broadcast
Supported "group addresses" of DALI ballast	0 ÷ 15
Power supply	
Power supply and communication	24 V (27 V) from the CIB
Nominal power consumption	22 mA
Max. power consumption	80 mA
Dimensions and weight	
Dimensions	max. 55 × 26 × 20mm
Weight	7 g
Operating and installation conditions	
Operating temperature	0 ÷ +70 °C
Storage temperature	-25 ÷ +85 °C
IP degree of protection acc. IEC 529	IP10B
Overvoltage category	II (according to EN 60664)
Degree of pollution	1 (according to EN 60664)
Operating position	arbitrary
Type of operation	continuous
Installation	
Type	under cover of device
Connecting	Ribbon cable 0.15 mm ²

DaliLib. If this library is not imported to the project, the project with the C-DL-0012S cannot be compiled !!!!

3.6.2. The structure of the transmitted data

Module contains 1 device in total:

- device 1, input/output, STAT+DATA_IN/CONT+DATA_OUT

The devices are incorporated into the structure of the transmitted data, which is evident from window *I/O setting* in the Mosaic. Window is accessible by pressing the icon  in toolbar.

Struktura dat	Úplný zápis	Alias	Svorka	Abs./délka
Statistic_MI_CIB1 : TCHStatistic	r0_p2_Statistic_MI_CIB1			%X0 / 10
Control_MI_CIB1 : TCHControl	r0_p2_Control_MI_CIB1			%Y0 / 2
ID1_IN : TC_DL_0012SIN	MI_CIB1_IN~ID1_IN			
stat : TStatC_DL_0012S	MI_CIB1_IN~ID1_IN~stat			
RNDOK : BOOL	MI_CIB1_IN~ID1_IN~stat~RNDOK			%R205.2
SHS : BOOL	MI_CIB1_IN~ID1_IN~stat~SHS			%R205.3
RRE : BOOL	MI_CIB1_IN~ID1_IN~stat~RRE			%R205.4
RRF : BOOL	MI_CIB1_IN~ID1_IN~stat~RRF			%R205.5
Done : BOOL	MI_CIB1_IN~ID1_IN~stat~Done			%R205.6
ARC : BOOL	MI_CIB1_IN~ID1_IN~stat~ARC			%R205.7
data : USINT	MI_CIB1_IN~ID1_IN~data			%R206
ID1_OUT : TC_DL_0012SOUT	MI_CIB1_OUT~ID1_OUT			
cont : TContC_DL_0012S	MI_CIB1_OUT~ID1_OUT~cont			
LENM : BOOL	MI_CIB1_OUT~ID1_OUT~cont~LENM			%R238.0
DBL : BOOL	MI_CIB1_OUT~ID1_OUT~cont~DBL			%R238.1
RNDS : BOOL	MI_CIB1_OUT~ID1_OUT~cont~RNDS			%R238.2
CHS : BOOL	MI_CIB1_OUT~ID1_OUT~cont~CHS			%R238.3
TRG : BOOL	MI_CIB1_OUT~ID1_OUT~cont~TRG			%R238.6
ACN : BOOL	MI_CIB1_OUT~ID1_OUT~cont~ACN			%R238.7
address : USINT	MI_CIB1_OUT~ID1_OUT~address			%R239
command : USINT	MI_CIB1_OUT~ID1_OUT~command			%R240
data : USINT	MI_CIB1_OUT~ID1_OUT~data			%R241

Fig. 3.16 The structure of the transmitted data

Input data

STAT	DATA
------	------

STAT - status byte of module (8x type bool)

	ARC	DONE	RRF	RRE	SHS	RNDOK	-	-
Bit	.7	.6	.5	.4	.3	.2	.1	.0

ARC - alternance bit of the receiver. In the case of the change this value one can accept the other bits in the STAT

DONE - flag of processing a request to send the message to the DALI bus

3.6. C-DL-0012S

0 = converter is ready for processing the request
 1 = converter processed the request

RRF - flag of the replies received from the DALI bus
 1 = reply delivered

RRE - error flag when receiving answers / at "random" addressing (if the *RRE* is set at „random“ addressing, is in the input variable *DATA* specified error at the same time)
 1 = error / collision when receiving answers / at "random" addressing

SHS - finding ballast in the "random" addressing

RNDOK - Exit from "random" addressing (the entire address space "random" addresses were searched)

DATA - response of the DALI bus / error code (type 1 usint)
 error codes:
 3 = Error of setting / verification of short addresses
 4 = required short address is out of range

Input data

CONT	ADDRESS	COMMAND	DATA
------	---------	---------	------

CONT - control word of module (8x type bool)

	ACN	TRG	-	-	CHS	RNDS	DBL	LENM
Bit	.7	.6	.5	.4	.3	.2	.1	.0

ACN - Alternance bit of transmitter. When the value is changed, other bits in *CONT* (if the other bits in the *CONT* are zero the flags in *STAT* are reset = reset mode) are accepted.

TRG - request to send messages to the DALI bus

CHS - Starting the search and addressing the ballast in the "random" addressing, the required short address must be currently registered in the variable *ADDRESS*

RNDS - Activation of the mode "random" addressing

DBL - requirement for multiple (double) sending the same message to the DALI bus. Repeated message will be sent within 100ms from the first message (requirement of some DALI messages)

LENM - length of transmitted DALI message
 0 = length 2 Byte (*ADDRESS*, *COMMAND*)
 1 = length 3 Byte (*ADDRESS*, *COMMAND*, *DATA*)

ADDRESS - address byte of DALI message (1x type usint)

COMMAND - control byte of DALI message (1x type usint)

DATA - data byte of DALI message (1x type usint)

Coding of DALI messages (in output variables *ADDRESS*, *COMMAND* and *DATA*) is defined by the DALI protocol specification.

3.6.3. Module specifics

CIB UNITS, MODULES

To serve the C-DL-0012S module it is **necessary** to install communication library DaliLib.mlb (otherwise the project cannot be compiled!!!).

3.7. C-DL-0064M

The module operates as a converter CIB bus on the bus DALI (according to specification *NEMA Standards Publication 243-2004*). DALI is bus specialized to control DALI lighting modules (ballasts). One converter C-DL-0064S can control up to 64 DALI ballasts. The converter has implemented system support for the "random" addressing the connected DALI ballasts.

Mechanical design corresponds to the modular design with width of 2M for mounting on the DIN-rail. After connecting the module to the CIB line (external power supply 24V DC) the green RUN LED lights still. If the module is served by the CIB (it communicates), green RUN LED flashes regularly.

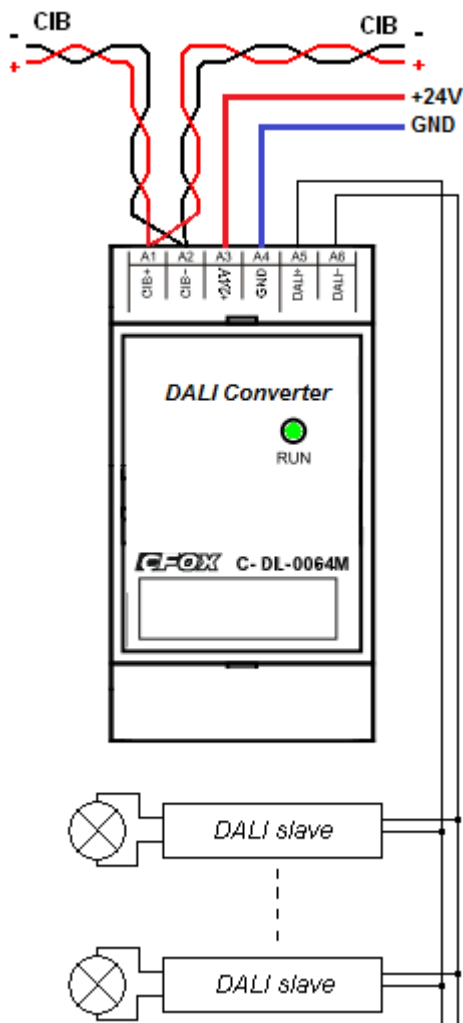

Fig. 3. 17 View and connection C-DL-0064M

Tab. 3.7 Basic parameters C-DL-0064M

DALI	
Number of connected DALI ballast	64
Supported "short addresses" of DALI ballast	0 ÷ 63, broadcast
Supported "group addresses" of DALI ballast	0 ÷ 15
Power supply and communication	
Power supply	24 V (from external power supply)
Nominal power consumption	30 mA
Max. power consumption	320 mA
Communication	CIB, DALI
Typical power consumption from CIB	0 mA
Dimensions and weight	
Dimensions	106 × 92 × 35mm
Weight	65 g
Operating and installation conditions	
Operating temperature	0 ÷ +70 °C
Storage temperature	-25 ÷ +85 °C
IP degree of protection acc. IEC 529	IP10B
Overvoltage category	II (according to EN 60664)
Degree of pollution	1 according to EN 60664
Operating position	arbitrary
Type of operation	continuous
Installation	
Type	on DIN rail
Connection terminals	Screw-type
Cross-section of wires	Max. 2,5 mm ²

3.7.1. Configuration

For software support of the module it is necessary library DaliLib.mlb imported in Mosaic. Configuration and serving Dali network is then performed using function blocks of this library. For detailed description of the library see documentation TXV 003 66 Library DaliLib. If this library is not imported to the project, the project with the C-DL-0064S cannot be compiled !!!!

3.7.2. The structure of the transmitted data

Module contains 1 device in total:

- device 1, input/output, STAT+DATA_IN/CONT+DATA_OUT

The devices are incorporated into the structure of the transmitted data, which is evident from window *I/O setting* in the Mosaic. Window is accessible by pressing the icon  in toolbar.

Struktura dat	Úplný zápis	Alias	Svorka	Abs./délka
Statistic_MI_CIB1 : TCHStatistic	r0_p2_Statistic_MI_CIB1			%X0 / 10
Control_MI_CIB1 : TCHControl	r0_p2_Control_MI_CIB1			%Y0 / 2
ID1_IN : TC_DL_0012SIN	MI_CIB1_IN~ID1_IN			
stat : TStatC_DL_0012S	MI_CIB1_IN~ID1_IN~stat			
RNDOK : BOOL	MI_CIB1_IN~ID1_IN~stat~RNDOK			%R205.2
SHS : BOOL	MI_CIB1_IN~ID1_IN~stat~SHS			%R205.3
RRE : BOOL	MI_CIB1_IN~ID1_IN~stat~RRE			%R205.4
RRF : BOOL	MI_CIB1_IN~ID1_IN~stat~RRF			%R205.5
Done : BOOL	MI_CIB1_IN~ID1_IN~stat~Done			%R205.6
ARC : BOOL	MI_CIB1_IN~ID1_IN~stat~ARC			%R205.7
data : USINT	MI_CIB1_IN~ID1_IN~data			%R206
ID1_OUT : TC_DL_0012SOUT	MI_CIB1_OUT~ID1_OUT			
cont : TContC_DL_0012S	MI_CIB1_OUT~ID1_OUT~cont			
LENM : BOOL	MI_CIB1_OUT~ID1_OUT~cont~LENM			%R238.0
DBL : BOOL	MI_CIB1_OUT~ID1_OUT~cont~DBL			%R238.1
RND5 : BOOL	MI_CIB1_OUT~ID1_OUT~cont~RND5			%R238.2
CHS : BOOL	MI_CIB1_OUT~ID1_OUT~cont~CHS			%R238.3
TRG : BOOL	MI_CIB1_OUT~ID1_OUT~cont~TRG			%R238.6
ACN : BOOL	MI_CIB1_OUT~ID1_OUT~cont~ACN			%R238.7
address : USINT	MI_CIB1_OUT~ID1_OUT~address			%R239
command : USINT	MI_CIB1_OUT~ID1_OUT~command			%R240
data : USINT	MI_CIB1_OUT~ID1_OUT~data			%R241

Fig. 3.18 The structure of the transmitted data

Input data

STAT	DATA
------	------

STAT - status byte of module (8x type bool)

	ARC	DONE	RRF	RRE	SHS	RNDOK	-	-
Bit	.7	.6	.5	.4	.3	.2	.1	.0

ARC - alternance bit of the receiver. In the case of the change this value one can accept the other bits in the STAT

DONE - flag of processing a request to send the message to the DALI bus

0 = converter is ready for processing the request

1 = converter processed the request

RRF - flag of the replies received from the DALI bus

1 = the reply was delivered

3.7. C-DL-0064M

- RRE* - error flag when receiving answers / at "random" addressing (if the *RRE* is set at „random“ addressing, is in the input variable *DATA* specified error at the same time)
 1 = error / collision when receiving answers / at "random" addressing
- SHS* - finding ballast in the "random" addressing
- RNDOK* - Exit from "random" addressing (the entire address space "random" addresses were searched)

- DATA* - response of the DALI bus / error code (type 1 usint)
 error codes:
 3 = Error of setting / verification of short addresses
 4 = required short address is out of range

Output data

CONT	ADDRESS	COMMAND	DATA
------	---------	---------	------

- CONT* - control word of module (8x type bool)

	ACN	TRG	-	-	CHS	RNDS	DBL	LENM
Bit	.7	.6	.5	.4	.3	.2	.1	.0

- ACN* - Alternance bit of transmitter. When the value is changed, other bits in *CONT* (if the other bits in the *CONT* are zero the flags in *STAT* are reset = reset mode) are accepted.
- TRG* - request to send messages to the DALI bus
- CHS* - Starting the search and addressing the ballast in the "random" addressing, the required short address must be currently registered in the variable *ADDRESS*
- RNDS* - Activation of the mode "random" addressing
- DBL* - requirement for multiple (double) sending the same message to the DALI bus. Repeated message will be sent within 100ms from the first message (requirement of some DALI messages)
- LENM* - length of transmitted DALI message
 0 = length 2 Byte (*ADDRESS*, *COMMAND*)
 1 = length 3 Byte (*ADDRESS*, *COMMAND*, *DATA*)

- ADDRESS* - address byte of DALI message (1x type usint)

- COMMAND* - control byte of DALI message (1x type usint)

- DATA* - data byte of DALI message (1x type usint)

Coding of DALI messages (in output variables *ADDRESS*, *COMMAND* and *DATA*) is defined by the DALI protocol specification.

3.7.3. Module specifics

CIB UNITS, MODULES

To serve the C-DL-0012S module it is **necessary** to install communication library DaliLib.mlb (otherwise the project cannot be compiled!!!).

3.8. C-DM-0006M-ILED

The module is designed for the **current** control of LED light sources e.g. LED chips). It includes 6 analog outputs for continuous control of up to 6 separate light sources (or 2 RGB light sources). The supply voltage for light sources is an external one in the range 4.5 to 48V DC. Nominal output current can be adjusted in steps of 150, 350, 500, or 700mA. The individual outputs can be locally manually controlled by buttons on the module. Mechanical design corresponds to the modular design with width of 3M for mounting on the DIN-rail.

The module is protected against overheating, when all outputs will be disconnected. Overheating is indicated in the status variable module.

After connecting the module to the CIB line (power connected) the green RUN LED lights still. If the module is served by the CIB (it communicates), green RUN LED flashes regularly.

Tab. 3.8 Basic parameters C-DM-0006M-ILED

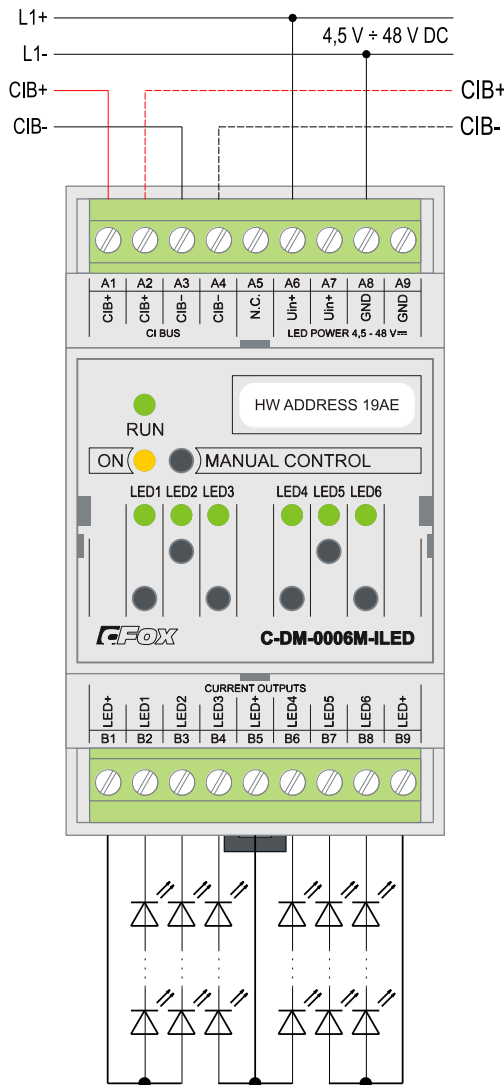

Analog outputs for LED lights	
Quantity	6
Nominal output current	150/350/500/700mA
Total output current	Max. 4.2A
Current of LED+ terminal	Max. 10A
Overload protection	No
Overheating protection	Yes
Power for LED outputs	
External supply	4.5 ÷ 48V DC, 5A
Power of module	
Power supply and communication	24 V (27 V) from the CIB
Max. power consumption	15 mA
Dimensions and weight	
Dimensions	90 × 58 × 53mm
Weight	120g
Operating and installation conditions	
Operating temperature	0 ÷ +45 °C
Storage temperature	-25 ÷ +85 °C
IP degree of protection acc. IEC 529	IP20B
Operating position	arbitrary
Type of operation	continuous
Installation	on DIN rail
Connection terminals	
Type	Screw-type
Cross-section of wires	Max. 4 mm ²

Fig. 3. 19 View and connection C-DM-0006M-ILED

3.8.1. Configuration

The screenshot shows a configuration window titled "C-DM-0006M-ILED" with the subtitle "Nastavení analogových výstupů". It contains six sections, one for each LED (LED1 through LED6). Each section has three dropdown menus: "Nastavení blokace" (Blockage setting), "Nastavení rampy (čas z 0% na 100%)" (Ramp time setting), and "Jmenovitý proud" (Nominal current). The "Nastavení blokace" dropdowns are all set to "Zmrazení aktuálního stavu". The "Nastavení rampy" dropdowns are all set to "Rampa udávaná v 1000 ms". The "Jmenovitý proud" dropdowns are set to 150 mA for LED1, 350 mA for LED2, 500 mA for LED3, 700 mA for LED4, 350 mA for LED5, and 350 mA for LED6. At the bottom, there are two checkboxes: "Blokovat manuální režim LED1, LED2, LED3" (unchecked) and "Blokovat manuální režim LED4, LED5, LED6" (unchecked). At the bottom right, there are two buttons: "OK" (with a green checkmark) and "Zrušit" (with a red X).

Fig. 3.20 Module configuration

Block setting

For individual LED outputs can be set whether the module during transition into HALT mode has to freeze its outputs or whether the outputs has to be cleared.

Ramp settings

For individual LED outputs can be set up the step for leading (falling) ramp to overrun from 0 to 100% (and vice versa). You can choose between steps of 100ms or steps of 1000ms. The specific ramp values are passed to the module in output data.

Nominal current

For each LED output can be set to the rated output current (representing the value of the output set at 100%). The current can be set for 150, 350, 500, 700mA.

Block of manual mode

To check the box the ability of manual control of specific LED outputs in RUN mode is blocked. In the HALT mode the manual control of LED outputs is allowed always.

In RUN mode, the manual control is activated by pressing the button *MANUAL CONTROL* on module. At the same time the yellow indicator LED lights up *ON*. Then it is possible to change the status of each output (0% / 100%). Another pressing the button *MANUAL CONTROL* LED indicator *ON* goes off and the manual mode is cancelled. Then LED outputs are controlled according to the commands of the CIB line. Activity of manual mode is also indicated in the module status variable *STAT.ManMode*.

3.8.1. The structure of the transmitted data

Module contains 4 devices in total:

- device 1, input, 1*STAT (status)
- device 2, input, 1*thermometer
- device 3, output, 3*AO (1-3)
- device 4, output, 3*AO (4-6)

The devices are incorporated into the structure of the transmitted data, which is evident from window *I/O setting* in the Mosaic. Window is accessible by pressing the icon  in toolbar.

Struktura dat	Úplný zápis	Alias	Svorka	Abs./délka	Hodnota
[-] ID1_IN : TMI_CIB1_ID1_IN	MI_CIB1_IN~ID1_IN				
[-] STAT : TCIB_CDM_STAT	MI_CIB1_IN~ID1_IN~STAT			%R204 / 1	\$00
[-] iTHERM : REAL	MI_CIB1_IN~ID1_IN~iTHERM			%RF205	0
[-] ID1_OUT : TMI_CIB1_ID1_OUT	MI_CIB1_OUT~ID1_OUT				
[-] LEDa : TCIB_CDM_LEDa	MI_CIB1_OUT~ID1_OUT~LEDa				
[-] LED1 : REAL	MI_CIB1_OUT~ID1_OUT~LEDa~LED1			%RF228	0
[-] ramp1 : USINT	MI_CIB1_OUT~ID1_OUT~LEDa~ramp1			%R232	0
[-] LED2 : REAL	MI_CIB1_OUT~ID1_OUT~LEDa~LED2			%RF233	0
[-] ramp2 : USINT	MI_CIB1_OUT~ID1_OUT~LEDa~ramp2			%R237	0
[-] LED3 : REAL	MI_CIB1_OUT~ID1_OUT~LEDa~LED3			%RF238	0
[-] ramp3 : USINT	MI_CIB1_OUT~ID1_OUT~LEDa~ramp3			%R242	0
[-] LEDb : TCIB_CDM_LEDb	MI_CIB1_OUT~ID1_OUT~LEDb				
[-] LED4 : REAL	MI_CIB1_OUT~ID1_OUT~LEDb~LED4			%RF243	0
[-] ramp4 : USINT	MI_CIB1_OUT~ID1_OUT~LEDb~ramp4			%R247	0
[-] LED5 : REAL	MI_CIB1_OUT~ID1_OUT~LEDb~LED5			%RF248	0
[-] ramp5 : USINT	MI_CIB1_OUT~ID1_OUT~LEDb~ramp5			%R252	0
[-] LED6 : REAL	MI_CIB1_OUT~ID1_OUT~LEDb~LED6			%RF253	0
[-] ramp6 : USINT	MI_CIB1_OUT~ID1_OUT~LEDb~ramp6			%R257	0

Fig. 3.21 The structure of the transmitted data

Input data

STAT	iTHERM
------	--------

STAT - status byte of module (8x type bool)

	OverHeat	ManMode	-	-	-	-	-	-
Bit	.7	.6	.5	.4	.3	.2	.1	.0

ManMode - signalling of manual mode of LED outputs.

OverHeat - overheating of module (LED outputs are disconnected)

iTHERM - internal module temperature (type real) [°C]

Output data

LEDa	LEDb
------	------

LEDx - the value of analog LEDx output (type real), 0÷100[%]

rampx - the value of leading/falling ramp of LEDx output (type usint), 0÷255
Depending on the selected step value it represents the ramp either
0÷255s or 0÷25.5s.

3.9. C-DM-0006M-ULED

The module is designed for the **voltage** control of LED light sources e.g. LED stripes). It includes 6 analog outputs for continuous control of up to 6 separate light sources (or 2 RGB light sources). The supply voltage for light sources is an external one (12V or 24V). Each output can be locally manually controlled by buttons on the module. Mechanical design corresponds to the modular design with width of 3M for mounting on the DIN-rail.

The individual LED outputs are protected against short circuit. During short circuit indication the respective output circuit turns off and the LED indicator is flashing. The module is also protected against overheating when the output is disconnected. Short circuit and overheating is indicated in the status variable module.

After connecting the module to the CIB line (power connected) the green RUN LED lights still. If the module is served by the CIB (it communicates), green RUN LED flashes regularly.

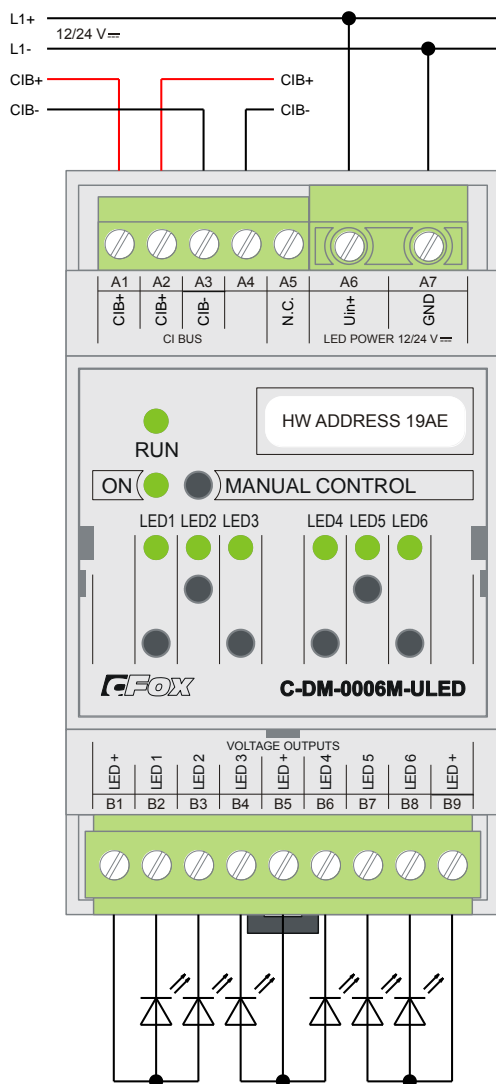

Tab. 3.9 Basic parameters C-DM-0006M-ULED

Analog outputs for LED lights	
Quantity	6
Output voltage	12/24V DC
Current of LED1-6 terminal	Max. 6A
Current of LED+ terminal	Max. 10A
Total output current	Max. 24A
Overload protection	Yes
Power for LED outputs	
External supply	12/24V DC, max. 24A
Power module	
Power supply and communication	24 V (27 V) from the CIB
Max. power consumption	15 mA
Dimensions and weight	
Dimensions	90 × 58 × 53mm
Weight	100g
Operating and installation conditions	
Operating temperature	0 ÷ +45 °C
Storage temperature	-25 ÷ +85 °C
IP degree of protection acc. IEC 529	IP10B
Operating position	arbitrary
Type of operation	continuous
Installation	on DIN rail
Connection terminals	
CIB	Screw-type
LED	Screw-type,, removable
Cross section of CIB, LED wires	Max. 2,5 mm ²
External power for LED	Screw-type
Cross section of wires of external supply of LED	Max. 4 mm ²

Fig. 3.22 View and connection C-DM-0006M-ULED

3.9.1. Configuration

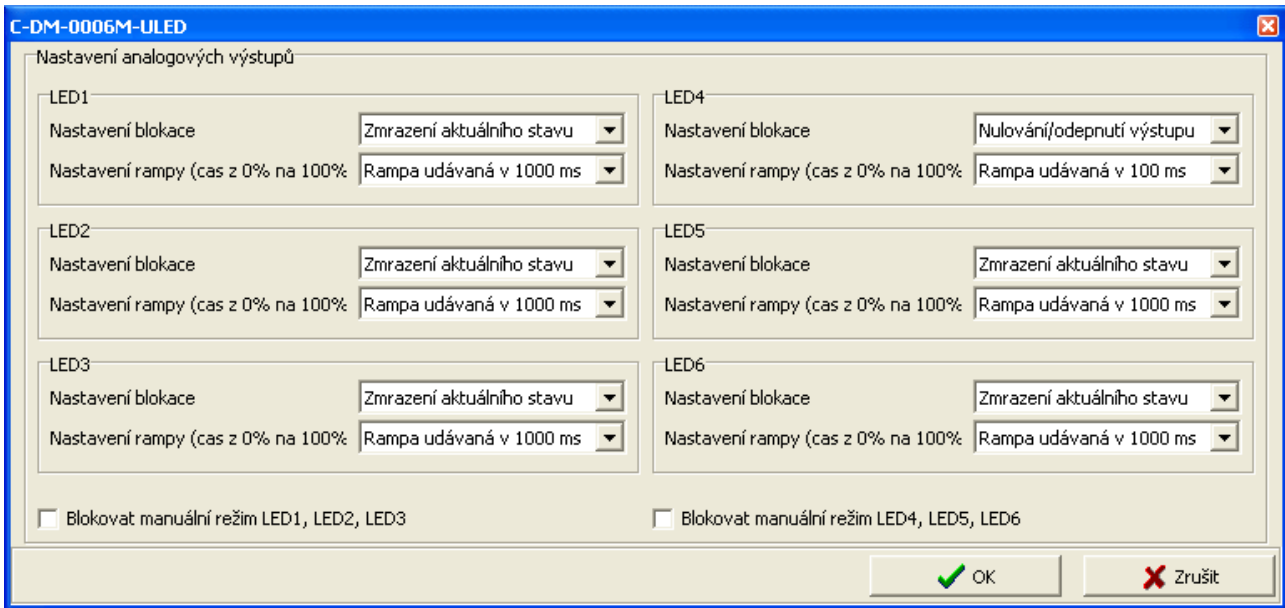

Fig. 3.23 Module configuration

Block setting

For individual LED outputs can be set whether the module during transition into HALT mode has to froze its outputs or whether the outputs has to be cleared.

Ramp settings

For individual LED outputs can be set up the step for leading (falling) ramp to overrun from 0 to 100% (and vice versa). The specific ramp values are passed to the module in output data.

Block of manual mode

Checking the box the ability to manually control specific LED outputs in RUN mode is blocked. In the HALT mode the manual control of LED outputs is allowed always.

In RUN mode, the manual control is activated by pressing the button *MANUAL CONTROL* on module. At the same time the yellow indicator LED lights up *ON*. Then it is possible to change the status of each output (0% / 100%). Another pressing the button *MANUAL CONTROL* LED indicator *ON* goes off and the manual mode is cancelled. Then LED outputs are controlled according to the commands of the CIB line. Activity of manual mode is also indicated in the module status variable *STAT.ManMode*.

3.9.2. The structure of the transmitted data

Module contains 4 devices in total:

- device 1, input, 1*STAT (status)
- device 2, input, 1*thermometer
- device 3, output, 3*AO
- device 4, output, 3*AO

3.9. C-DM-0006M-ULED

The devices are incorporated into the structure of the transmitted data, which is evident from window *I/O setting* in the Mosaic. Window is accessible by pressing the icon  in toolbar.

Struktura dat	Úplný zápis	Alias	Svorka	Abs./délka	Hodnota
[-] ID1_IN : TMI_CIB1_ID1_IN	MI_CIB1_IN~ID1_IN				
[-] STAT : TCIB_CDM_STAT	MI_CIB1_IN~ID1_IN~STAT			%R204 / 1	\$00
[-] iTHERM : REAL	MI_CIB1_IN~ID1_IN~iTHERM			%RF205	0
[-] ID1_OUT : TMI_CIB1_ID1_OUT	MI_CIB1_OUT~ID1_OUT				
[-] LEDa : TCIB_CDM_LEDa	MI_CIB1_OUT~ID1_OUT~LEDa				
[-] LED1 : REAL	MI_CIB1_OUT~ID1_OUT~LEDa~LED1			%RF228	0
[-] ramp1 : USINT	MI_CIB1_OUT~ID1_OUT~LEDa~ramp1			%R232	0
[-] LED2 : REAL	MI_CIB1_OUT~ID1_OUT~LEDa~LED2			%RF233	0
[-] ramp2 : USINT	MI_CIB1_OUT~ID1_OUT~LEDa~ramp2			%R237	0
[-] LED3 : REAL	MI_CIB1_OUT~ID1_OUT~LEDa~LED3			%RF238	0
[-] ramp3 : USINT	MI_CIB1_OUT~ID1_OUT~LEDa~ramp3			%R242	0
[-] LEDb : TCIB_CDM_LEDb	MI_CIB1_OUT~ID1_OUT~LEDb				
[-] LED4 : REAL	MI_CIB1_OUT~ID1_OUT~LEDb~LED4			%RF243	0
[-] ramp4 : USINT	MI_CIB1_OUT~ID1_OUT~LEDb~ramp4			%R247	0
[-] LED5 : REAL	MI_CIB1_OUT~ID1_OUT~LEDb~LED5			%RF248	0
[-] ramp5 : USINT	MI_CIB1_OUT~ID1_OUT~LEDb~ramp5			%R252	0
[-] LED6 : REAL	MI_CIB1_OUT~ID1_OUT~LEDb~LED6			%RF253	0
[-] ramp6 : USINT	MI_CIB1_OUT~ID1_OUT~LEDb~ramp6			%R257	0

Fig. 3.24 The structure of the transmitted data

Input data

STAT	iTHERM
------	--------

STAT - status byte of module (8x type bool)

	OverHeat	ManMode	OverLoad6	OverLoad1
Bit	.7	.6	.5	.4	.3	.2	.1	.0

OverLoadx - short circuit on LEDx output

ManMode - signalling of manual mode of LED outputs.

OverHeat - overheating of module (LED outputs are disconnected)

iTHERM - internal module temperature (type real) [°C]

Output data

LEDa	LEDb
------	------

LEDx - the value of analog LEDx output (type real), 0÷100[%]

rampx - the value of leading/falling ramp of LEDx output (type usint), 0÷255
Depending on the selected step value it represents the ramp either 0÷255s or 0÷25.5s.

3.10. C-DM-0402M-RLC

The module is designed to control the light intensity (luminous flux) of most dimmable loads powered by mains voltage 230 V ~. It includes 2 dimmer outputs and 4 universal AI/DI inputs (configurable in pairs). The dimmer is suitable for dimming resistive, inductive or capacitive loads. Dimmer works on the principle of phase control of the angle of the on or off.

Each output can be locally manually controlled by buttons on the module (ON/OFF). The outputs are protected against short circuit and overheating module.

After connecting the module to the CIB line (power connected) the green RUN LED lights still. If the module is served by the CIB (it communicates), green RUN LED flashes regularly. Mechanical design corresponds to the modular design with width of 3M for mounting on the DIN-rail.

3.10. C-DM-0402M-RLC

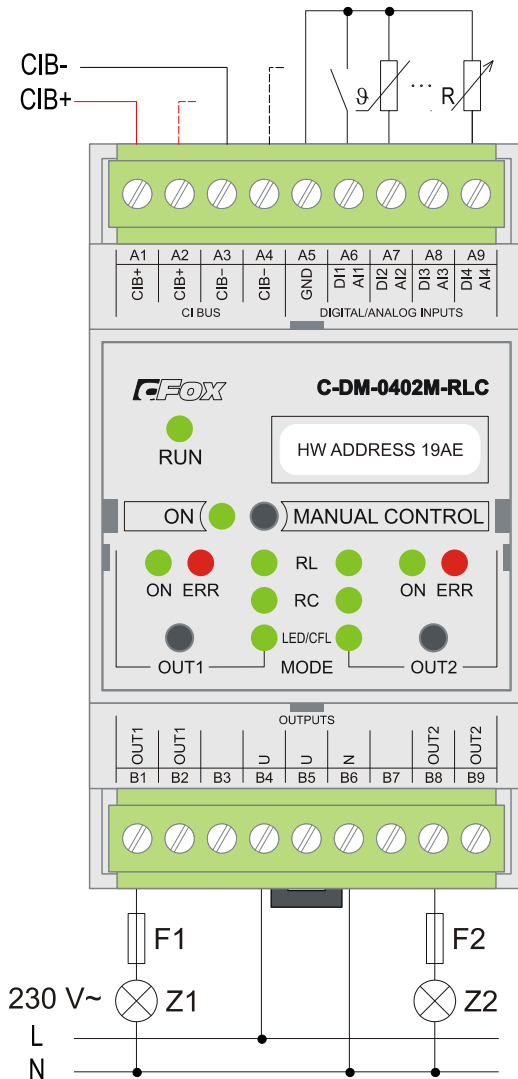

Fig. 3. 25 View and connecting C-DM-0402M-RLC

Tab. 3.10 Basic parameters C-DM-0402M-RLC

Dimmer outputs OUT	
Quantity	2
Type of load	R, L, C, RL, RC, LED, CFL
Power load	230V AC / 50Hz
Switching power	Max. 2 x 500 VA ¹⁾
Output current	Max. 2 x 2.2A
Overload protection	Yes
Overheating protection	Yes
Parallel work	Yes, max. 4 channels (on the same CIB line)
The power element	NMOS transistor
Universal inputs AI/DI	
Quantity	4
Optional input type	Binary (button), balanced (for security detectors), Pt1000, Ni1000, NTC-12kΩ, KTY81-121, resistance 160kΩ
Binary input	NO contact (0/1) (Normally Open)
Balanced input for security detectors	Resistance 1x2k2, or 2x1k1
Pt1000	-90 ÷ +320 °C
Ni1000	-60 ÷ +200 °C
NTC 12kΩ	-40 ÷ +125 °C
KTY81-121	-55 ÷ +125 °C
Resistance input	0 ÷ 160kΩ
Resolution, Accuracy	0.1 °C / 10Ω, 0.5 % of range
Period of refresh AI	typically 5s
Power module	
Power supply and communication	24 V (27 V) from the CIB
Max. power consumption	20 mA
Dimensions and weight	
Dimensions	90 × 58 × 53mm
Weight	120g
Operating and installation conditions	
Operating temperature	0 ÷ +55 °C ¹⁾
Storage temperature	-25 ÷ +85 °C
IP degree of protection acc. IEC 529	IP20
Operating position	vertical
Type of operation	continuous
Installation	on DIN rail
Connection terminals	
Type	Screw-type
Cross-section of wires	Max. 2,5 mm ²

¹⁾ because of the module cooling, spacing between modules is recommended
min. 15mm (temperature derating curve module see next)

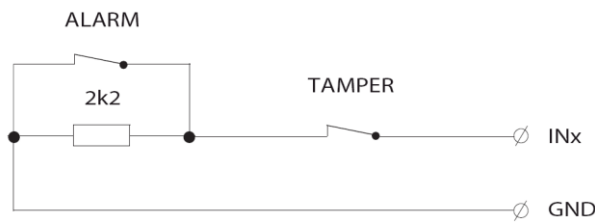

Fig. 3. 26 Simply balanced input for security detectors

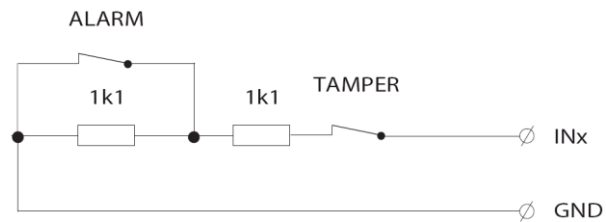

Fig. 3. 27 Double-balanced input for security detectors

3.10.1. Configuration

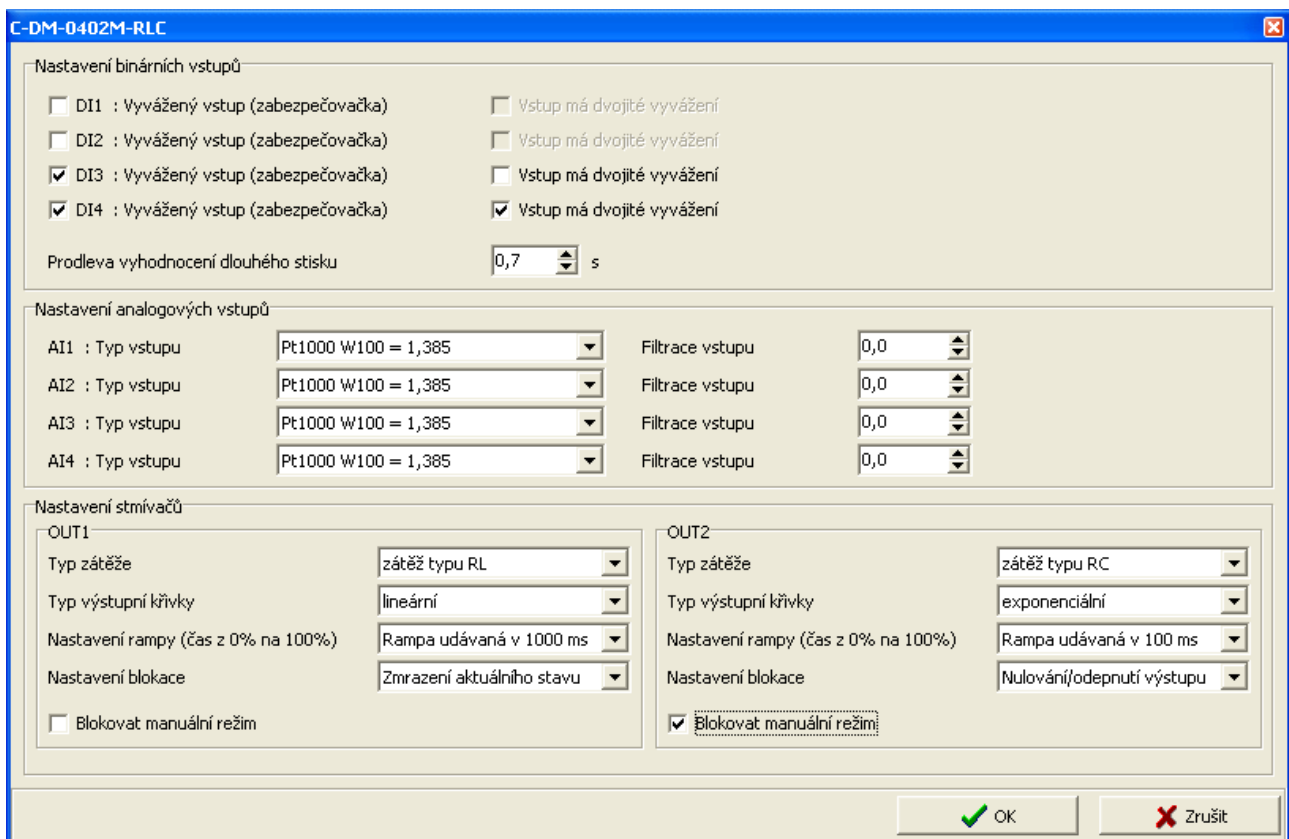

Fig. 3.28 Module configuration

The input terminals DI/AIx are **shared** for binary and analog inputs (for digital and analog equipment). As the input is configured as analog one, **it is not possible** use it as binary input **in the same time**. Depending on the configured input (as enabled devices) specific items of configuration dialog are enabled/disabled. Enabling devices see. chap. 2.1 *Master configuration*, check the box *Show units, devices*

Balanced input

By checking the item, the respective input will be evaluated as a simple balanced binary alarm input. If the item is not checked, the respective input evaluated as a normal binary input (on/off).

Double balanced input

By checking the item, respective input will be evaluated as a double balanced binary alarm input. If the item is not checked and the input is configured for security systems (balanced input), the respective input evaluated as alarm input with a simple balance.

Delay, evaluation of long press

For binary (momentary button) inputs module directly evaluate the short and long presses on each input. By entering values one can set a delay time after which the activation of digital input DI is signalled as the long press (PRESS). Activating the digital input for period shorter than the entered value will be signalled by as the short press (CLICK). Delay period (T_{press}) can be inserted in the range 0.1÷2.5s.



Fig. 3. 29 Evaluation of short / long press

Type of input

Choosing the type of analog input:

Pt1000, $W_{100} = 1,385$, -90/+320°C

Pt1000, $W_{100} = 1,391$, -90/+320°C

Ni1000, $W_{100} = 1,617$, -60/+200°C

Ni1000, $W_{100} = 1,500$, -60/+200°C

NTC 12k (negative thermistor, 12kΩ at 25°C), -40/+125°C

KTY 81-121, -55/+125°C

OV160k (0 ÷ 160kΩ)

Input filtering

By specifying a non-zero value of the time constant, the 1st order digital filter is activated. The filter is given by

$$y_t = \frac{y_{t-1} \cdot \tau + x}{\tau + 1}$$

- x - the current value of the analog input
- y_t - output
- y_{t-1} - recent output
- τ -time constant of the 1st order filter (TAU)

Value of time constant is set in the range 0.1 ÷ 25.4 and it represents a time constant in the range of 100 ms ÷ 25.4 s (value 255 is intended for service purposes).

Type of load

The dimmer allows to set the type of the inductive load RL or capacitive RC one. Selected type of load is simultaneously indicated by corresponding RL or RC indicator lights on the module.

If the output has simultaneously set the "ignition" output value (in variable *OUTx.MINIMUM*), the corresponding CFL/LED indicator lights. In such case if the output of the dimmer is required lower than this minimum value, the output is inactive

Type	Principle of the control	Example of the load
RL	angle switching on switching off when passing through the sine wave zero	<ul style="list-style-type: none"> - bulb - dimmable compact fluorescent lamp (CFL) - dimmable LED bulb - transformer (winding)
RC	switching on when passing through the sine wave zero, angle switching off	<ul style="list-style-type: none"> - Bulb - electronic ballast

Warning : When connecting non-dimmable lamps to the dimmer their irreparable damage threats!!!

Type of characteristic output curve

Dimmer works on the principle of phase control of the angle of the on or off. Angle to switch on (switch off) depends on the desired percentage value of the output (in variable *OUTx.LEVEL*, 0÷100%). This dependence curve can be set in the module as:

- linear
- logarithmic

Type of dependence curves has to be set according to the requirement of behaviour of specific load.

Ramp settings

For each dimmer outputs the leading (falling) ramp can be set up. The specific ramp values are passed to the module in output data (variables *OUTx.RAMP*) and represent the running time of the output 0% <-> 100%.

Block setting

For individual dimmer outputs can be set whether the module during transition into HALT mode has to froze its outputs or whether the outputs has to be cleared.

Block of manual mode

Checking the box the ability to manually control specific dimmer outputs in RUN mode is blocked. In the HALT mode the manual control of dimmer outputs is allowed always.

In RUN mode, the manual control is activated by pressing the button *MANUAL CONTROL* on module. At the same time the yellow indicator LED lights up *ON*. Then it is possible to change the status of each output (0% / 100%). Another pressing the button *MANUAL CONTROL* LED indicator *ON* goes off and the manual mode is cancelled. Then LED outputs are controlled according to the commands of the CIB line. Activity of manual mode is also indicated in the module status variable *STAT.ManMode*.

3.10.2. The structure of the transmitted data

Module contains 6 devices in total:

- device 1, input, 4*DI/EZS
- device 2, input/output, 1*DIMM (OUT1)
- device 3, input/output, 1*DIMM (OUT2)
- device 4, input, STAT + THERM
- device 5, input, 2*AI (AI1, AI2)
- device 6, input, 2*AI (AI3, AI4)

The devices are incorporated into the structure of the transmitted data, which is evident from window *I/O setting* in the Mosaic. Window is accessible by pressing the icon  in toolbar.

Struktura dat	Úplný zápis	Alias	Svorka	Abs./délka	Hodnota
[-] ID1_IN : TMI_CIB1_ID1_IN	MI_CIB1_IN~ID1_IN				
[-] DI : TCIB_CDMRLC_DI	MI_CIB1_IN~ID1_IN~DI			%R4 / 2	
[-] ACT_LEVEL1 : REAL	MI_CIB1_IN~ID1_IN~ACT_LEVEL1			%RF6	0
[-] ACT_LEVEL2 : REAL	MI_CIB1_IN~ID1_IN~ACT_LEVEL2			%RF10	0
[-] STAT : TCIB_CDMRLC_STAT	MI_CIB1_IN~ID1_IN~STAT			%R14 / 2	
[-] THERM : REAL	MI_CIB1_IN~ID1_IN~THERM			%RF16	0
[-] AI1 : REAL	MI_CIB1_IN~ID1_IN~AI1			%RF20	0
[-] AI2 : REAL	MI_CIB1_IN~ID1_IN~AI2			%RF24	0
[-] AI3 : REAL	MI_CIB1_IN~ID1_IN~AI3			%RF28	0
[-] AI4 : REAL	MI_CIB1_IN~ID1_IN~AI4			%RF32	0
[-] ID1_OUT : TMI_CIB1_ID1_OUT	MI_CIB1_OUT~ID1_OUT				
[-] OUT1 : TCIB_CDMRLC_DIM	MI_CIB1_OUT~ID1_OUT~OUT1				
[-] LEVEL : REAL	MI_CIB1_OUT~ID1_OUT~OUT1~LEVEL			%RF36	0
[-] RAMP : USINT	MI_CIB1_OUT~ID1_OUT~OUT1~RAMP			%R40	0
[-] MINIMUM : REAL	MI_CIB1_OUT~ID1_OUT~OUT1~MINIMUM			%RF41	20
[-] OUT2 : TCIB_CDMRLC_DIM	MI_CIB1_OUT~ID1_OUT~OUT2				
[-] LEVEL : REAL	MI_CIB1_OUT~ID1_OUT~OUT2~LEVEL			%RF45	0
[-] RAMP : USINT	MI_CIB1_OUT~ID1_OUT~OUT2~RAMP			%R49	0
[-] MINIMUM : REAL	MI_CIB1_OUT~ID1_OUT~OUT2~MINIMUM			%RF50	20

Fig. 3.30 The structure of the transmitted data

Input data

DI	ACT_LEVEL1	ACT_LEVEL2	STAT	THERM	AI1	AI2	AI3	AI4
----	------------	------------	------	-------	-----	-----	-----	-----

DI - status of binary inputs, signalling "tamper" status of alarm inputs (16x bool)

	CLICK4	CLICK3	CLICK2	CLICK1	DI4	DI3	DI2	DI1
Bit	.7	.6	.5	.4	.3	.2	.1	.0

	TAMPER4	TAMPER3	TAMPER2	TAMPER1	PRESS4	PRESS3	PRESS2	PRESS1
Bit	.15	.14	.13	.12	.11	.10	.9	.8

- DIx - Current status of binary input DIx / alarm input x
- CLICKx - short pulse (to log. 1) on input DIx

CIB UNITS, MODULES

PRESSx - long pulse (to log. 1) on input Dlx
TAMPERx - „tamper“ status of alarm input x
ACT_LEVELx - current status of output OUTx (type real) [%]

STAT - status byte of module (16x type bool)

	VLD4	OUF4	VLD3	OUF3	VLD2	OUF2	VLD1	OUF1
Bit	.7	.6	.5	.4	.3	.2	.1	.0

	-	PWR_ERR	HEAT	ERR2	ERR1	MAN	VLDT	OUFF
Bit	.15	.14	.13	.12	.11	.10	.9	.8

OUFx - overflow / underflow of analog input Alx
VLDx - validity of reading of analog input Alx
OUFF - overflow / underflow of internal thermometer range
VLDT - internal thermometer reading validity
ManMode - signalling of manual mode of dimmer outputs.
ERRx - overload / short circuit on the output OUTx (the output x is disconnected)
HEAT - thermal overheating module
 If the temperature of the module will be higher than 65 ° C, it will automatically relieve both outputs transition to the "ignition" value. If the temperature is higher than 70 ° C, it will automatically disconnect both outputs.. The return to normal operating mode occurs automatically after cooling module temperature below 60 ° C.
PWR_ERR - main power 230V AC is not connected

iTHERM - internal module temperature (type real) [°C]

Alx - value of analog input Alx (type real) [°C],[kΩ]
 The value of temperature sensor is transferred in °C (with resolution of 0.1°C), the value of general resistance in range 160kΩ is transferred in kΩ (with resolution of 10Ω).

Output data

OUT1	OUT2
------	------

OUTx.LEVEL - value of output OUTx (type real), 0÷100[%]

OUTx.RAMP - the value of leading/falling ramp of output OUTx (type usint), 0÷255
 Depending on the selected step of ramp the value represents a ramp of length 0 ÷ 255s, or 0 to 25.5s. The ramp represents the running time output 0% <-> 100%.

OUTx.MINIMUM - "ignition" value of output OUTx (type real), 0÷100[%]
 In such case if the output of the dimmer (in value **OUTx.LEVEL**) is required lower than this minimum value, the output is inactive.
 This variable is automatically reset on value 20%.

3.10.3. Module specifics

System support of CFox master

For proper function of the module C-DM-0402-RLC **the system support** is required in CFox master. This system support has been implemented into CFox **master** CF-1140 / CF-1141 in FW version **1.7** (into master MI2-01M / MI2-02M in version 2.0). If the master versions is lower, dimmer module will not work correctly (outputs will not be operated, ERR LED will flash 3 times briefly)

Operating temperature and self heating of the module

To ensure the stable operation of the module it is necessary to keep **the maximum permissible ambient temperature**. The inner space of the module during operation is additionally heated by own heat dissipation, which is proportional to dimming load of both the channel and to the character of dimming. For maximum performance, especially when installing multiple dimmers together, it is appropriate to use active cooling (fan, etc.), which ensures controlled airflow around the dimmers. Due to the cooling of module the lateral spacing between the modules in width min. 15mm is also recommended.

Eventual overheating of the module is automatically diagnosed and signalled (see chapter *Diagnostics module* below). Influence of ambient temperature on the power capabilities of the module is shown in the following chart.

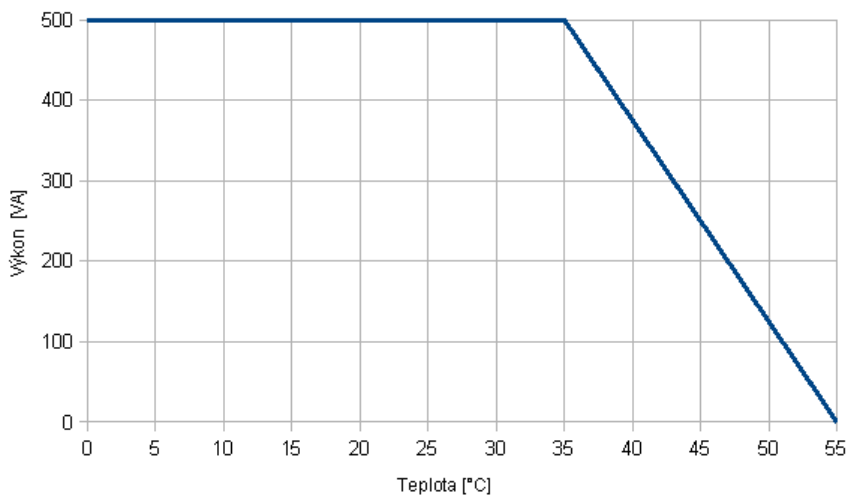

Paralleling the outputs of the dimmer

If the required control output loads are beyond the performance capabilities of one output, it is possible to connected more outputs in parallel for one load. **Up to 4** outputs can be interconnected in parallel way. Modules C-DM-0402M-RLC of such interconnected outputs has to be connected **on the same CIB line**. When configuring the module it is necessary to have all interconnected outputs **identically configured and operated**. Otherwise, there would be an overload of individual outputs and subsequent shutdown of all interconnected outputs.

In manual control mode such parallel interconnected outputs it is recommended to change

the status of individual outputs (by buttons on the module) when the power is off (disconnected fuse / circuit breaker is off).

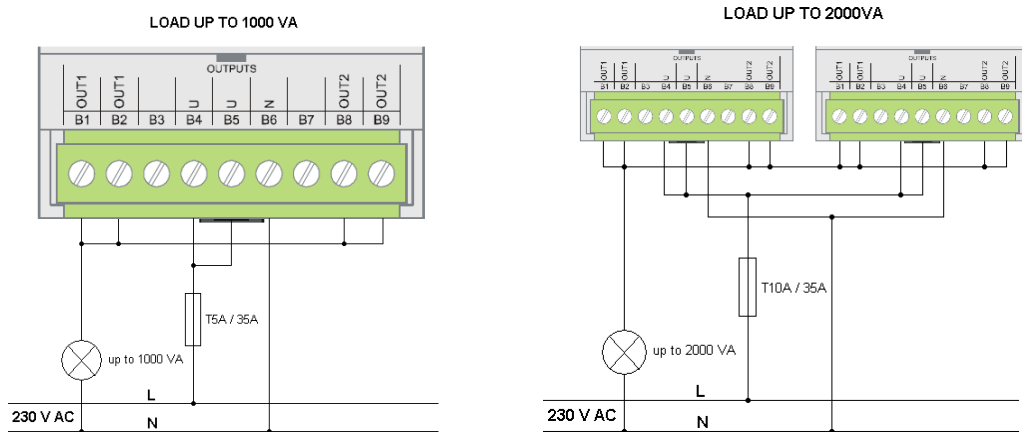

3.10.4. Module diagnostics

Dimmer includes a number of diagnostic tools for operation of the module. Result of diagnosis is available in the status byte of module *STAT* (see chapter structure of the transmitted data). Some results of diagnosis are also signalled via LEDs on the module.. The meaning is described in the following table.

ERR LED	Description
Still lights	Overload evaluated (short circuit) of the output (signalling in <i>STAT.ERRx</i>). The output is automatically turned off (function of breaker). Unlocking the output is performed: <ol style="list-style-type: none"> by pressing the appropriate button <i>OUTx</i> or by writing the value 0% into variable <i>OUTx.LEVEL</i>.
1x short flash	module is overheated (signalling in <i>STAT.HEAT</i>). Both outputs are automatically set into "ignition" value (> 65 ° C).When the temperature continues to rise the outputs turn off (>70°C). Unlocking outputs is performed automatically after cooling module (below 60 ° C)
2x short flash	PWR_ERR - main power 230V AC is not connected
3x short flash	The system support from CFox master is not available, the outputs will not be operated. It is necessary to upgrade firmware in the master. See chapter <i>Module Specifics</i> above.

3.11. C-HC-0201F-E

Module is the proportional (continuous) drive to control the central heating radiator valves. The module - drive - contains an internal temperature sensor and 2 universal inputs, which can be connected to either an external resistive temperature sensor or an external binary signal (e.g. window contact). The module is equipped with an automatic adaptation of the drive depending on the used valve and with the function of regular spinning tracks valve (prevention valve seizure). For diagnostic functions module contains a signalling LED and control button MAN (both available after removing the module cover). Connecting the CIB is indicated RUN LED, module in operation is indicated by flashing RUN LED.

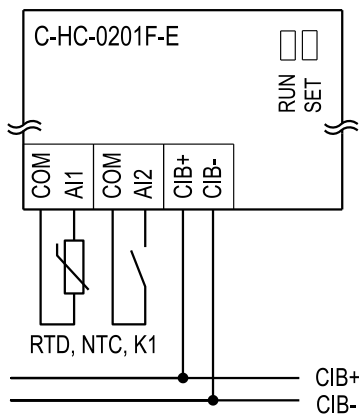
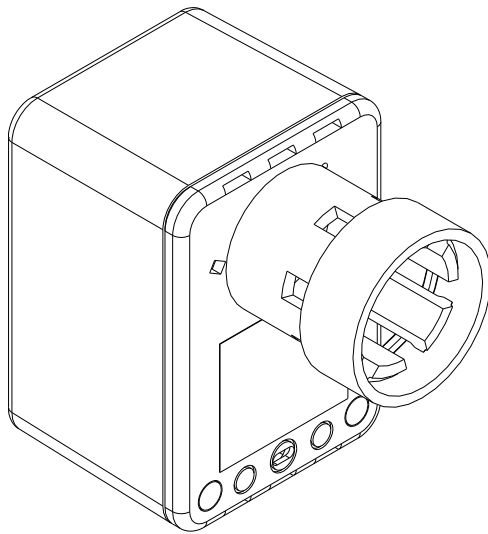

Fig. 3.1 View and connection of module

Tab. 3.11 Basic parameters C-HC-0201F-E

The drive	
Type of drive	proportional (continuous)
Stroke of the drive ¹⁾	typ. 1.5 mm (max. 2.7 mm)
Time of run from 0% to 100%	approx.30 s
Adaptation of the drive	automatic + manual
Spinning of valve	automatic, interval of 30 days
Internal thermometer	
Type	NTC
Range of measurement	-10 ÷ +50 °C
Accuracy	+/- 5% of range
Settling time	30 min.
Universal inputs	
Quantity	2
Optional input type	Binary or analog
Binary inputs ²⁾	
Type	Dry contact
Input voltage	3.3V from internal power supply
Input current at log.1	typ. 3.3mA
Analog outputs ²⁾	
Pt1000	-90 ÷ +320 °C
Ni1000	-60 ÷ +200 °C
NTC 12kΩ	-40 ÷ +125 °C
KTY81-121	-55 ÷ +125 °C
Resistance input	0 ÷ 160kΩ
Accuracy	+/- 2 % of range
Period of refresh AI	typically 5s
Operating and installation conditions	
Indication (internal)	2x LED, green, RUN, SET
Button (internal)	1x MAN
Operating temperature	-10 ÷ +50 °C
Storage temperature	-25 ÷ +70 °C
Installation	mounted on the valve
Thread of coupling nut	M30 x 1.5
Type of operation	continuous
IP degree of protection acc. IEC 529	IP0xB
Connection terminals	Push-in 0.14 ÷ 1.5mm ²
Power supply	
Power supply and communication	24 V (27 V) from the CIB
Nominal power consumption	5 mA (non operating drive)
Max. power consumption	80 mA (drive in action)
Dimensions and weight	
Dimensions	69 × 48 × 73 mm
Weight	125g

¹⁾ The stroke of the drive can be configured

²⁾ Inputs can be used either as binary or analog ones

3.11.1. Configuration

The screenshot shows a configuration window for the C-HC-0201F-E module. The window title is "C-HC-0201F-E". It contains a section titled "Nastavení analogových vstupů" (Analog input settings). This section includes four rows of configuration options:

- Typ vstupu AI1: Pt1000 W100 = 1,385 (dropdown menu)
- Filtrace vstupu AI1: 0,0 (spin box)
- Typ vstupu AI2: Pt1000 W100 = 1,385 (dropdown menu)
- Filtrace vstupu AI2: 0,0 (spin box)

Below these are four more configuration options:

- Offset dráhy pohonu [mm]: 0,00 (spin box)
- Offset odlehčení těsnění [mm]: 0,00 (spin box)
- Při ztrátě komunikace: Zmrazení aktuálního stavu (dropdown menu)
- Koncová poloha: NO - ventil úplně otevřen (dropdown menu)

At the bottom of the window are two buttons: "OK" (with a green checkmark icon) and "Zrušit" (with a red X icon).

Fig. 3.2 Module configuration

The input terminals AI1 and AI2 are **shared** for both binary and analog inputs (for digital and analog equipment). As the input is configured as analog one, **it is not possible** use it as binary input **in the same time**. Depending on the configured input (as enabled devices) specific items of configuration dialog are enabled/disabled. Enabling devices see. chap. [2.1](#) *Master configuration* , check the box *Show units, devices* .

Type of input

Choosing the type of analog input:

- Pt1000, $W_{100} = 1,385$, $-90/+320^{\circ}\text{C}$
- Pt1000, $W_{100} = 1,391$, $-90/+320^{\circ}\text{C}$
- Ni1000, $W_{100} = 1,617$, $-60/+200^{\circ}\text{C}$
- Ni1000, $W_{100} = 1,500$, $-60/+200^{\circ}\text{C}$
- NTC 12k (negative thermistor, $12\text{k}\Omega$ at 25°C), $-40/+125^{\circ}\text{C}$
- KTY 81-121, $-55/+125^{\circ}\text{C}$
- OV600k ($0 \div 630\text{k}\Omega$)
- OV6M ($0 \div 6,5\text{M}\Omega$)

Input filtering

By specifying a non-zero value of the time constant, the 1st order digital filter is activated. The filter is given by

$$y_t = \frac{y_{t-1} \cdot \tau + x}{\tau + 1}$$

- x - the current value of the analog input
- y_t - output
- y_{t-1} - recent output
- τ -time constant of the 1st order filter (TAU)

Value of time constant is set in the range $0.1 \div 25.4$ and it represents a time constant in the range of $100 \text{ ms} \div 25.4 \text{ s}$ (value 255 is intended for service purposes).

Offset of the drive track

The drive head works with preset actuator stroke 1.5 mm (movement from the fully open to fully closed position). For the case where the required other stroke of drive/actuator, this value can be corrected in range $+ / - 1.2 \text{ mm}$

Offset of seal relieve

During adapting the actuator to the valve the end position of the valve is found (mechanical stop), which represents a full closure of the valve. Due to the natural deformation of the sealing element in the end position of the valve, adapting of "lightening" of the sealing element is then carried out by reversing of the drive motion for the default stroke of 0.3 mm. This position then represents the reference position, representing the valve opening 0%. Preset relieve of 0.3 mm can be corrected by a user in the range $-0.3 \text{ mm} / +1.2 \text{ mm}$.

In case the loss of communication

If the operated drive module evaluates the loss of communication with a superior master, you can set whether the position of the actuator should freeze (keep the current state), or if the drive is set to the specified end position (see below).

End position

One can specify whether the end position of the valve actuator (in case of loss of communication) is a fully open or complete closed one.

3.11.2. The structure of the transmitted data

Module contains 5 devices in total:

- device 1, input, 1*AI_STAT (status of temperature input)
- device 2, input, 2*AI (external thermometers)
- device 3, input, 1*AI (internal thermometer)
- device 4, input, 2*DI (binary input)
- device 5, input/output, VSTAT + VCONT (status information of the actuator + control command for actuator)

The devices are incorporated into the structure of the transmitted data, which is evident from window *I/O setting* in the Mosaic. Window is accessible by pressing the icon  in toolbar.

Struktura dat	Úplný zápis	Alias	Svorka	Abs./délka	Hodnota
[-] ID1_IN : TMI_CIB1_ID1_IN	MI_CIB1_IN~ID1_IN				
[-] STAT : TCIB_CHC_STAT	MI_CIB1_IN~ID1_IN~STAT			%R4 / 1	\$00
[-] AI : TCIB_AI2	MI_CIB1_IN~ID1_IN~AI				
AI1 : REAL	MI_CIB1_IN~ID1_IN~AI~AI1			%RF5	0
AI2 : REAL	MI_CIB1_IN~ID1_IN~AI~AI2			%RF9	0
iTHERM : REAL	MI_CIB1_IN~ID1_IN~iTHERM			%RF13	0
[-] DI : TCIB_DI2	MI_CIB1_IN~ID1_IN~DI				\$00
DI1 : BOOL	MI_CIB1_IN~ID1_IN~DI~DI1			%R17.0	0
DI2 : BOOL	MI_CIB1_IN~ID1_IN~DI~DI2			%R17.1	0
[-] VSTAT : TCIB_VCHC_STAT	MI_CIB1_IN~ID1_IN~VSTAT				
READY : BOOL	MI_CIB1_IN~ID1_IN~VSTAT~READY			%R18.0	0
RUN : BOOL	MI_CIB1_IN~ID1_IN~VSTAT~RUN			%R18.1	0
FS : BOOL	MI_CIB1_IN~ID1_IN~VSTAT~FS			%R18.6	0
SERVICE : BOOL	MI_CIB1_IN~ID1_IN~VSTAT~SERVICE			%R18.7	0
POSITION : REAL	MI_CIB1_IN~ID1_IN~VSTAT~POSITION			%RF19	0
[-] ID1_OUT : TMI_CIB1_ID1_OUT	MI_CIB1_OUT~ID1_OUT				
[-] VCONT : TCIB_VCHC_CONT	MI_CIB1_OUT~ID1_OUT~VCONT				
INIT : BOOL	MI_CIB1_OUT~ID1_OUT~VCONT~INIT			%R23.0	0
POSITION : REAL	MI_CIB1_OUT~ID1_OUT~VCONT~POSITION			%RF24	0

Fig. 3.3 The structure of the transmitted data

Input data

STAT	AI	iTHERM	DI	VSTAT
------	----	--------	----	-------

STAT - status byte of temperature inputs (8x type bool)

Bit	.7	.6	.5	.4	.3	.2	.1	.0
	-	-	VLDI	OUIF	VLD2	OUIF2	VLD1	OUIF1

OUIFx - overflow/underflow of the range of external temperature sensor x

VLDx - validity of the reading of external temperature sensor x

OUIF1 - overflow/underflow of the range of internal temperature sensor x

VLDx - validity of the reading of internal temperature sensor x

AI - value of analog inputs (2x type real) [°C],[kΩ]

AI1 - value of analog input AI1

AI2 - value of analog input AI2

The value of temperature sensor is transferred in °C (with resolution of 0.1°C), the value of general resistance in range 160kΩ is transferred in kΩ (with resolution of 10Ω).

THERM - temperature of auxiliary internal sensor (type real) [°C]

DI - status of binary inputs (8x type bool)

Bit	.7	.6	.5	.4	.3	.2	.1	.0
	-	-	-	-	-	-	DI2	DI1

DI1 - the current status of the binary DI1 input

DI2 - the current status of the binary DI2 input

CIB UNITS, MODULES

VSTAT - status information about the actuator(8x type bool + 1x type real)

	SERVICE	FS	-	-	-	-	RUN	READY
Bit	.7	.6	.5	.4	.3	.2	.1	.0

VSTAT.READY - availability of the actuator for acceptance of the position set point, during the adaptation this flag is in log.0

VSTAT.RUN - signalling of the engine operation (position adjusting)

VSTAT.FS - frost protection, opens drive to the maximum, setpoint of actuator position is not accepted

VSTAT.SERVICE - service mode of module (it is activated by MAN button on the module, actuator is opened at maximum), the desired actuator position is not accepted

VSTAT.POSITION - actual position of the actuator (type real) [%]

Output data

VCONT

VCONT - actuator control commands (8x type bool)

	-	-	-	-	-	-	-	INIT
Bit	.7	.6	.5	.4	.3	.2	.1	.0

INIT - activation of the drive adaptation mode (from the leading edge), for a period of adaptation is the flag VSTAT.READY is in log.0

VCONT.POSITION - set point of the actuator position (type real) [0÷100%]

3.11.3. Module specifics

After connecting the module to the CIB bus the module perform automatic adaptation of actuator with the valve. Adaptation can also be caused by setting the user flag **VCONT.INIT**, or by the MAN service button on the module. MAN button is available after removing the plastic cover cap. After pressing and releasing it in the interval 1.5s after the required number of flashes of green LED SET one of the actions that are described in the following table can be called.

Number of flashes	Action
2	opening the actuator for 100% (designed for disassembly / assembly the actuator on the valve), the actuator remains open until the call of adaptation procedure or until the restart.
3	performing the adaptation of actuator with the valve

The module has implemented automatic antifreeze protection function. If the internal temperature sensor evaluates temperature lower than +5 ° C, the actuator (valve) is opened to 100%. At the same time the flag desired position of the variable **VSTAT.FS** is set and the desired position from the variable **VCONT.POSITION** is not accepted by the module.

3.11.4. Installation

Terminals for connection on the CIB bus and for connection of external sensors are available after removing the plastic cover (see basic documentation for the module).

During assembly / disassembly of the module on the valve is necessary to have the drive always in the open position (the plug is inserted back into the head, the opening can be done by pressing the MAN button, see above). After mounting the module on the valve it is **always necessary** to perform the adaptation of the module with the valve (adaptation can be done by the MAN button, by restart - disconnect the power supply - or by setting the flag *VCONT.INIT*, see above).

3.12. C-HM-0308M

The module contains 3 universal inputs (analog/digital) for dry contacts or resistive sensors, 2 current analog outputs (0÷10V) and 6 relay outputs. Analog inputs are configurable according to the type of sensor, relay outputs allow local manual control buttons on the module. Mechanical design corresponds to the modular design with width of 3M for mounting on the DIN-rail.

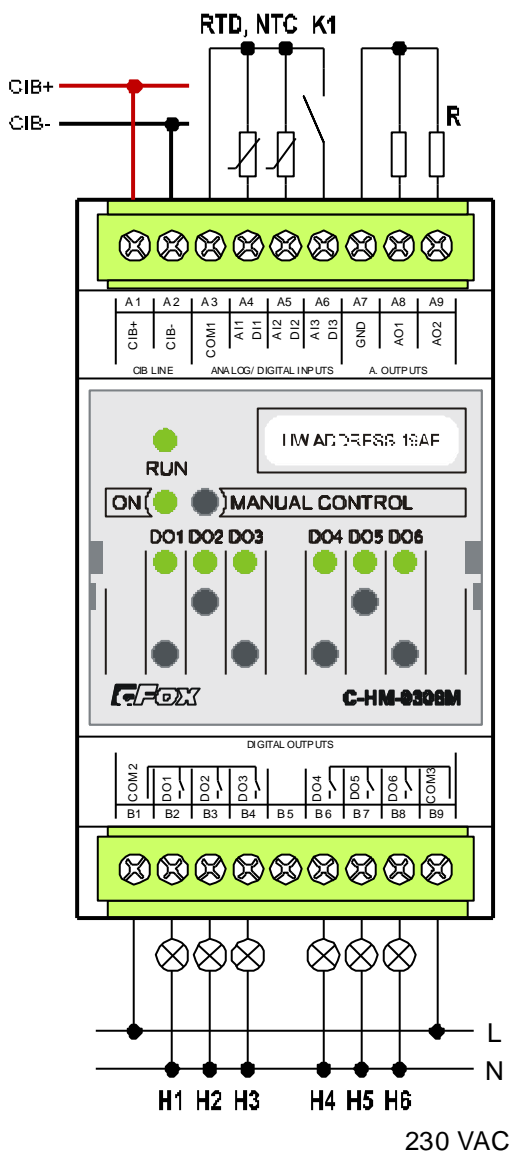

Fig. 3. 4 View and connection C-HM-0308M

Tab. 3.12 Basic parameters C-HM-0308M

Binary inputs ¹⁾	
Quantity, type	3, NO contact
Input voltage	2,5V from internal power supply
Galvanic isolation	No
Analog inputs ¹⁾	
Quantity	3
Type of convertor	Approximation, 12 bit
Range of measurement - resistor	Pt1000 (-90/+320°C), Ni1000 (-60/+200°C), NTC12k (-40/+125°C), KTY81-121 (-55/+125°C), OV600k (0 ÷ 630kΩ), OV6M (0 ÷ 6,5MΩ),
- voltage ^{*)}	2V (0 ÷ 2,1V), 1V (0 ÷ 1,05V), 100mV (0 ÷ 105mV), 50mV (0 ÷ 52,5mV)
Error of input	3% of full range,
Analog outputs	
Quantity	2
Type	Active, voltage, 8 bits
Range	0 ÷ 10,5V
Max. output current	10mA
Error of input	2% of full range,
Binary outputs	
Quantity	6
Type	Switching relay
Switched voltage	Max. 250V, min. 5V
Switched current	Max. 3A, min. 100mA
Galvanic isolation	Yes, also among the groups
Current of the common terminal of the group	Max. 10A
Protection against inductive load	External (RC circuit, diode, varistor)
Power supply	
Power supply and communication	24 V (27 V) from the CIB
Max. power consumption	90 mA
Dimensions and weight	
Dimensions	90 × 58 × 53mm
Weight	125g
Operating and installation conditions	
Operating temperature	0 ÷ +55 °C
Storage temperature	-25 ÷ +70 °C
IP degree of protection acc. IEC 529	IP10B
Operating position	vertical
Type of operation	continuous
Installation	on DIN rail
Connection terminals	Screw-type, removable
Cross-section of wires	Max. 2,5 mm ²

¹⁾ Terminals for AI and DI are common (universal inputs)

3.12.1. Configuration

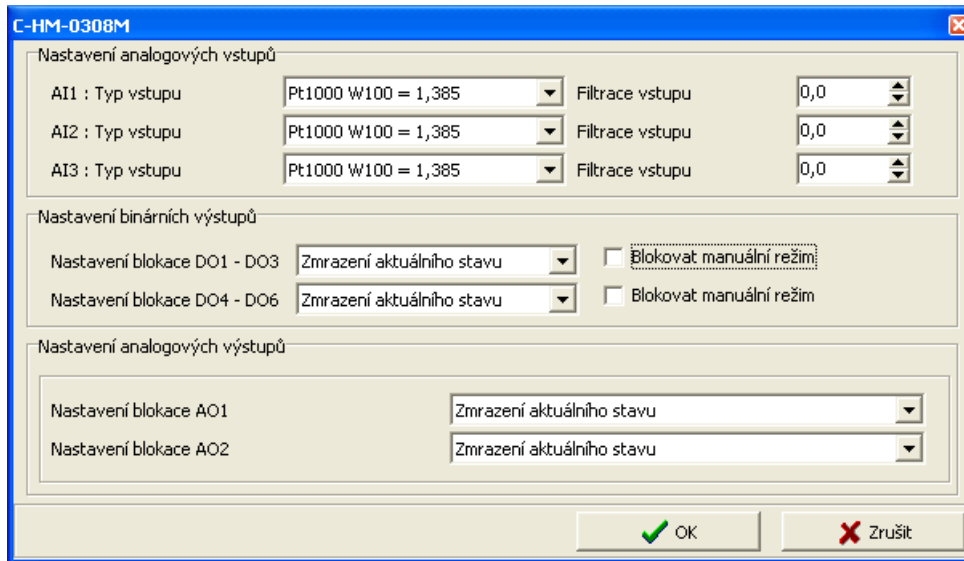

Fig. 3.5 Module configuration

Type of input

Choosing the type of analog input:

- Pt1000, $W_{100} = 1,385$, $-90/+320^{\circ}\text{C}$
- Pt1000, $W_{100} = 1,391$, $-90/+320^{\circ}\text{C}$
- Ni1000, $W_{100} = 1,617$, $-60/+200^{\circ}\text{C}$
- Ni1000, $W_{100} = 1,500$, $-60/+200^{\circ}\text{C}$
- NTC 12k (negative thermistor, $12\text{k}\Omega$ at 25°C), $-40/+125^{\circ}\text{C}$
- KTY 81-121, $-55/+125^{\circ}\text{C}$
- OV600k ($0 \div 630\text{k}\Omega$)
- OV6M ($0 \div 6,5\text{M}\Omega$)
- 2V ($0 \div 2,1\text{V}$)
- 1V ($0 \div 1,05\text{V}$)
- 100mV ($0 \div 105\text{mV}$)
- 50mV ($0 \div 50\text{mV}$)

Input filtering

By specifying a non-zero value of the time constant, the 1st order digital filter is activated. The filter is given by

$$y_t = \frac{y_{t-1} \cdot \tau + x}{\tau + 1}$$

- x - the current value of the analog input
- y_t - output
- y_{t-1} - recent output
- τ -time constant of the 1st order filter (TAU)

Value of time constant is set in the range $0.1 \div 25.4$ and it represents a time constant in the range of $100 \text{ ms} \div 25.4 \text{ s}$ (value 255 is intended for service purposes).

Block setting of DOx

Block setting AOx

For binary outputs (groups of binary outputs) DO and for analog outputs AO can be set whether the module during transition into HALT mode freezes its outputs on the last state or whether the outputs has to be cleared.

Block of manual mode

Checking the box the ability of manual control of binary outputs (group of binary outputs) in RUN mode is blocked. In the HALT mode the manual control of binary outputs is allowed always.

In RUN mode, the manual control is activated by pressing the button *MANUAL CONTROL* on module. At the same time the yellow indicator LED lights up *ON*. Then it is possible to change the status of each output by respective buttons. Another pressing the button *MANUAL CONTROL* LED indicator *ON* goes off and the manual mode is cancelled. Then binary outputs are controlled according to the commands of the CIB line. Activity of manual mode is also indicated in the module status variable *STAT.ManMode*.

3.12.2. The structure of the transmitted data

Module contains 5 devices in total:

- device 1, input, 1*STAT (status)
- device 2, input, 3*AI
- device 3, input, 2*AO
- device 4, input, 3*DI
- device 5, input, 6*DO

The devices are incorporated into the structure of the transmitted data, which is evident from window *I/O setting* in the Mosaic. Window is accessible by pressing the icon  in toolbar.

Struktura dat	Úplný zápis	Alias	Svorka	Abs./délka	Hodnota
[-] ID1_IN : TMI_CIB1_ID1_IN	MI_CIB1_IN~ID1_IN				
[-] STAT : TCIB_CHM0308_STAT	MI_CIB1_IN~ID1_IN~STAT			%R204 / 1	\$00
[-] AI : TCIB_AI3	MI_CIB1_IN~ID1_IN~AI				
[-] AI1 : REAL	MI_CIB1_IN~ID1_IN~AI~AI1			%RF205	0
[-] AI2 : REAL	MI_CIB1_IN~ID1_IN~AI~AI2			%RF209	0
[-] AI3 : REAL	MI_CIB1_IN~ID1_IN~AI~AI3			%RF213	0
[-] DI : TCIB_DI3	MI_CIB1_IN~ID1_IN~DI				\$00
[-] DI1 : BOOL	MI_CIB1_IN~ID1_IN~DI~DI1			%R217.0	0
[-] DI2 : BOOL	MI_CIB1_IN~ID1_IN~DI~DI2			%R217.1	0
[-] DI3 : BOOL	MI_CIB1_IN~ID1_IN~DI~DI3			%R217.2	0
[-] ID1_OUT : TMI_CIB1_ID1_OUT	MI_CIB1_OUT~ID1_OUT				
[-] AO : TCIB_AO2	MI_CIB1_OUT~ID1_OUT~AO				
[-] AO1 : REAL	MI_CIB1_OUT~ID1_OUT~AO~AO1			%RF218	0
[-] AO2 : REAL	MI_CIB1_OUT~ID1_OUT~AO~AO2			%RF222	0
[-] DOs : TCIB_DO6	MI_CIB1_OUT~ID1_OUT~DOs				\$00
[-] DO1 : BOOL	MI_CIB1_OUT~ID1_OUT~DOs~DO1			%R226.0	0
[-] DO2 : BOOL	MI_CIB1_OUT~ID1_OUT~DOs~DO2			%R226.1	0
[-] DO3 : BOOL	MI_CIB1_OUT~ID1_OUT~DOs~DO3			%R226.2	0
[-] DO4 : BOOL	MI_CIB1_OUT~ID1_OUT~DOs~DO4			%R226.3	0
[-] DO5 : BOOL	MI_CIB1_OUT~ID1_OUT~DOs~DO5			%R226.4	0
[-] DO6 : BOOL	MI_CIB1_OUT~ID1_OUT~DOs~DO6			%R226.5	0

Fig. 3.6 The structure of the transmitted data

Input data

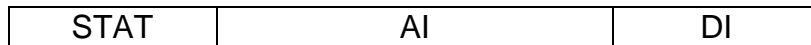

STAT - status byte of module (8x type bool)

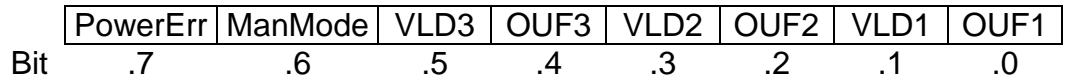

OUFx - overflow / underflow of analog input measurement *AIx*
VLDx - validity of reading of analog input *AIx*
ManMode - signalling of manual mode of binary outputs.
PowerErr - supply voltage drop below the limit for guaranteed switching of relay outputs *DO*

AIx - value of analog inputs (3x type real)
 - for temperature sensor temperature [°C]
 - for resistor sensor OV600k resistor [kΩ]
 - for resistor sensor OV6M resistor [MΩ]
 - for voltage range voltage [mV]

DIx - value of binary inputs (3x type bool)

Output data

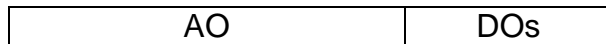

AOx - value of analog outputs (2x type real) [%]

DOx - value of binary outputs (6x type bool)

3.13. C-HM-1113M

Module contains 8 binary inputs for dry contacts, 3 analog inputs for resistor sensors, 2 voltage analog outputs (0÷10V) and 11 relay outputs. Analog inputs are configurable according to the type of sensor, relay outputs allow local manual control buttons on the module. Mechanical design corresponds to the modular design with width of 6M for mounting on the DIN-rail.

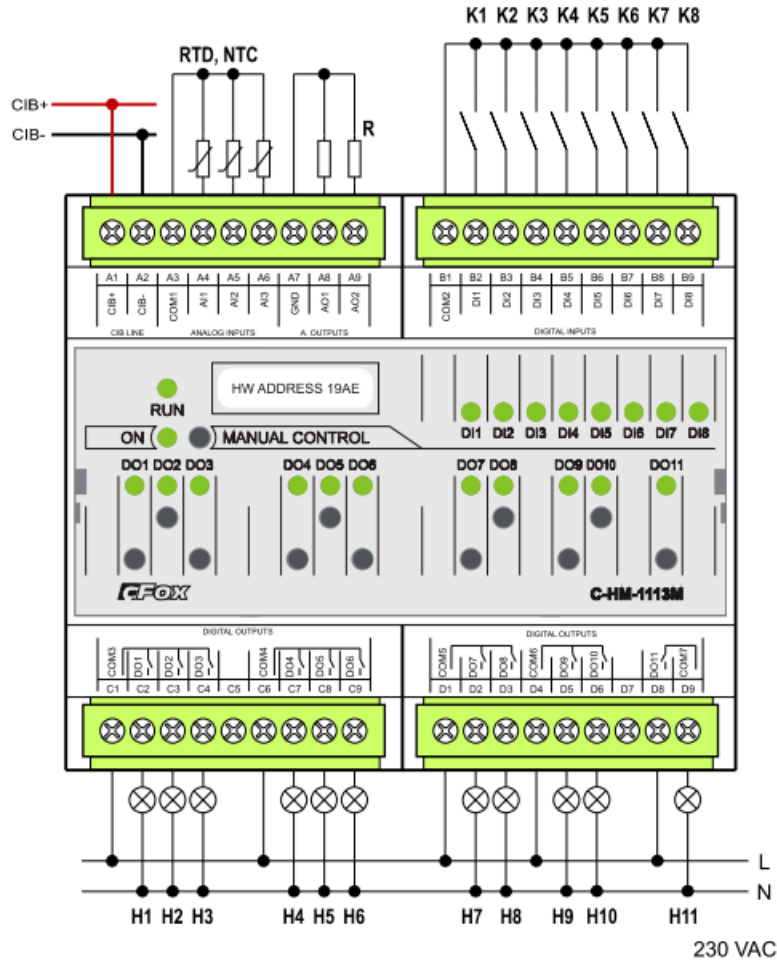

Fig. 3. 7 View and connection C-HM-1113M

Tab. 3.13 Basic parameters C-HM-1113M

Binary inputs	
Quantity, type	8, NO contacts
Input voltage	10V from internal power supply
Galvanic isolation	No
Binary outputs	
Quantity	11
Type	Switching relay
Switched voltage	Max. 250V, min. 5V
Switched current	Max. 3A, min. 100mA, DO11 max. 10A
Galvanic isolation	Yes, even among groups, with the exception of COM5 and COM6
Current of the common terminal of the group	Max. 10A
Protection against inductive load	External (RC circuit, diode, varistor)
Analog outputs	
Quantity	2
Type	Active, voltage, 8 bits
Range	0 ÷ 10,5V
Max. output current	10mA
Error of output	2% of full range,
Power supply	
Power supply and communication	24 V (27 V) from the CIB
Max. power consumption	160 mA

Analog inputs	
Quantity	3
Type of convertor	Approximation, 12 bit
Range of measurement	Pt1000 (-90/+320°C), Ni1000 (-60/+200°C), NTC12k (-40/+125°C), KTY81-121(-55/+125°C), OV600k (0 ÷ 630kΩ), OV6M (0 ÷ 6,5MΩ), 2V (0 ÷ 2,1V), 1V (0 ÷ 1,05V), 100mV (0 ÷ 105mV), 50mV (0 ÷ 52,5mV)
- resistor	
- voltage ^{*)}	
Error of input	3% of full range,

^{*)} Available from version 1.5 of module firmware

Dimensions and weight	
Dimensions	90 × 58 × 105mm
Weight	270g
Operating and installation conditions	
Operating temperature	0 ÷ +55 °C
Storage temperature	-25 ÷ +70 °C
IP degree of protection acc. IEC 529	IP10B
Operating position	vertical
Type of operation	Continuous
Installation	on DIN rail
Connection terminals	Screw-type, removable
Cross-section of wires	Max. 2,5 mm ²

3.13.1. Configuration

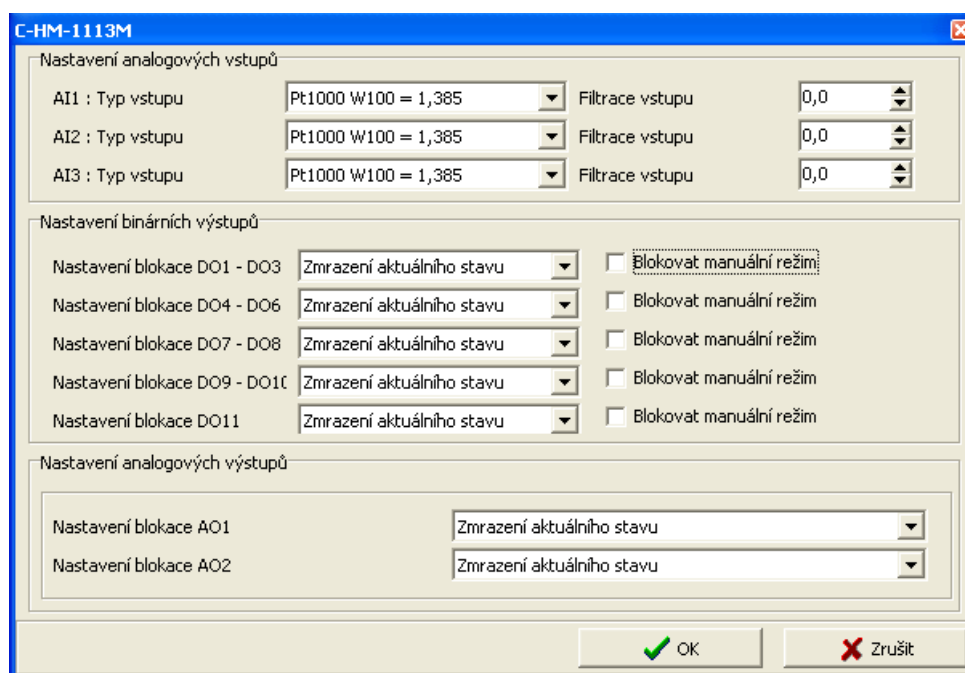

Fig. 3.8 Module configuration

Type of input

Choosing the type of analog input:

Pt1000, $W_{100} = 1,385$, -90/+320°C

Pt1000, $W_{100} = 1,391$, -90/+320°C

Ni1000, $W_{100} = 1,617$, -60/+200°C

Ni1000, $W_{100} = 1,500$, -60/+200°C

NTC 12k (negative thermistor, 12kΩ at 25°C), -40/+125°C

KTY 81-121, -55/+125°C

OV600k (0 ÷ 630kΩ)

OV6M (0 ÷ 6,5MΩ)

2V (0 ÷ 2,1V)

1V (0 ÷ 1,05V)

100mV (0 ÷ 105mV)

50mV (0 ÷ 50mV)

Input filtering

By specifying a non-zero value of the time constant, the 1st order digital filter is activated. The filter is given by

$$y_t = \frac{y_{t-1} \cdot \tau + x}{\tau + 1}$$

- x - the current value of the analog input
- y_t - output
- y_{t-1} - recent output
- τ - time constant of the 1st order filter (TAU)

Value of time constant is set in the range 0.1 ÷ 25.4 and it represents a time constant in the range of 100 ms ÷ 25.4 s (value 255 is intended for service purposes).

Block setting of DOx

Block setting AOx

For binary outputs (groups of binary outputs) DO and for analog outputs AO can be set whether the module during transition into HALT mode freezes its outputs on the last state or whether the outputs has to be cleared.

Block of manual mode

Checking the box the ability of manual control of binary outputs (group of binary outputs) in RUN mode is blocked. In the HALT mode the manual control of binary outputs is allowed always.

In RUN mode, the manual control is activated by pressing the button *MANUAL CONTROL* on module. At the same time the yellow indicator LED lights up *ON*. Then it is possible to change the status of each output by respective buttons. Another pressing the button *MANUAL CONTROL* LED indicator *ON* goes off and the manual mode is cancelled. Then binary outputs are controlled according to the commands of the CIB line. Activity of manual mode is also indicated in the module status variable *STAT.ManMode*.

3.13.2. The structure of the transmitted data

Module contains 5 devices in total:

- device 1, input, 1*STAT (status)
- device 2, input, 3*AI
- device 3, output, 2*AO
- device 4, output, 8*DI
- device 5, output, 11*DO

The devices are incorporated into the structure of the transmitted data, which is evident from window *I/O setting* in the Mosaic. Window is accessible by pressing the icon  in toolbar.

Struktura dat	Úplný zápis	Alias	Svorka	Abs./délka	Hodnota
[-] ID1_IN : TMI_CIB1_ID1_IN	MI_CIB1_IN~ID1_IN				
[-] STAT : TCIB_CHM0308_STAT	MI_CIB1_IN~ID1_IN~STAT			%R204 / 1	\$00
[-] AI : TCIB_AI3	MI_CIB1_IN~ID1_IN~AI				
[-] AI1 : REAL	MI_CIB1_IN~ID1_IN~AI~AI1			%RF205	0
[-] AI2 : REAL	MI_CIB1_IN~ID1_IN~AI~AI2			%RF209	0
[-] AI3 : REAL	MI_CIB1_IN~ID1_IN~AI~AI3			%RF213	0
[-] DI : TCIB_DI8	MI_CIB1_IN~ID1_IN~DI				\$00
[-] DI1 : BOOL	MI_CIB1_IN~ID1_IN~DI~DI1			%R217.0	0
[-] DI2 : BOOL	MI_CIB1_IN~ID1_IN~DI~DI2			%R217.1	0
[-] DI3 : BOOL	MI_CIB1_IN~ID1_IN~DI~DI3			%R217.2	0
[-] DI4 : BOOL	MI_CIB1_IN~ID1_IN~DI~DI4			%R217.3	0
[-] DI5 : BOOL	MI_CIB1_IN~ID1_IN~DI~DI5			%R217.4	0
[-] DI6 : BOOL	MI_CIB1_IN~ID1_IN~DI~DI6			%R217.5	0
[-] DI7 : BOOL	MI_CIB1_IN~ID1_IN~DI~DI7			%R217.6	0
[-] DI8 : BOOL	MI_CIB1_IN~ID1_IN~DI~DI8			%R217.7	0
[-] ID1_OUT : TMI_CIB1_ID1_OUT	MI_CIB1_OUT~ID1_OUT				
[-] AO : TCIB_AO2	MI_CIB1_OUT~ID1_OUT~AO				
[-] AO1 : REAL	MI_CIB1_OUT~ID1_OUT~AO~AO1			%RF218	0
[-] AO2 : REAL	MI_CIB1_OUT~ID1_OUT~AO~AO2			%RF222	0
[-] DOs : TCIB_DO11	MI_CIB1_OUT~ID1_OUT~DOs				\$0000
[-] DO1 : BOOL	MI_CIB1_OUT~ID1_OUT~DOs~DO1			%R226.0	0
[-] DO2 : BOOL	MI_CIB1_OUT~ID1_OUT~DOs~DO2			%R226.1	0
[-] DO3 : BOOL	MI_CIB1_OUT~ID1_OUT~DOs~DO3			%R226.2	0
[-] DO4 : BOOL	MI_CIB1_OUT~ID1_OUT~DOs~DO4			%R226.3	0
[-] DO5 : BOOL	MI_CIB1_OUT~ID1_OUT~DOs~DO5			%R226.4	0
[-] DO6 : BOOL	MI_CIB1_OUT~ID1_OUT~DOs~DO6			%R226.5	0

Fig. 3.9 The structure of the transmitted data

Input data

STAT	AI	DI
------	----	----

STAT - status byte of module (8x type bool)

	PowerErr	ManMode	VLD3	OUF3	VLD2	OUF2	VLD1	OUF1
Bit	.7	.6	.5	.4	.3	.2	.1	.0

- OUFx - overflow / underflow of analog input measurement AIx
- VLDx - validity of reading of analog input AIx
- ManMode - signalling of manual control mode of binary outputs.

3.13. C-HM-1113M

PowerErr - supply voltage drop below the limit for guaranteed switching of relay outputs DO

AIx - value of analog inputs (3x type real) [°C] [kΩ] [MΩ] [mV]

DIx - value of binary inputs (8x type bool)

Output data

AO	DOs
----	-----

AOx - value of analog outputs (2x type real) [%]

DOx - value of binary outputs (11x type bool)

3.14. C-HM-1121M

Module contains 8 binary inputs for dry contacts, 3 analog inputs for resistor sensors, 2 voltage analog outputs (0÷10V) and 19 relay outputs. Analog inputs are configurable according to the type of sensor, relay outputs allow local manual control buttons on the module. Mechanical design corresponds to the modular design with width of 9M for mounting on the DIN-rail.

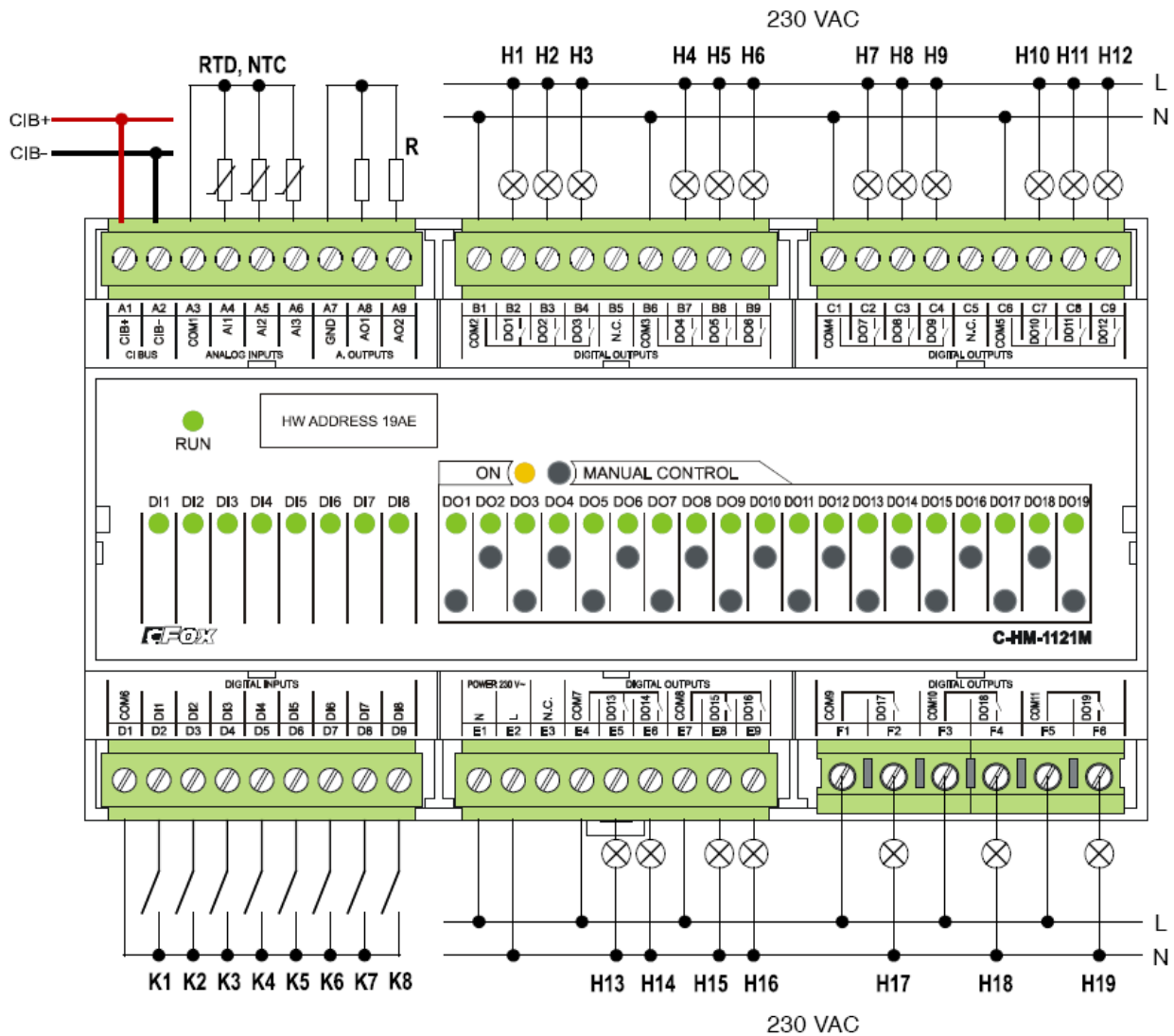

Fig. 3. 10 View and connection C-HM-1121M

3.14. C-HM-1121M

Tab. 3.14 Basic parameters C-HM-1121M

Analog outputs	
Quantity	2
Type	Active, voltage, 8 bits
Range	0 ÷ 10,5V
Max. output current	10mA
Error of input	2% of full range,
Power supply	
Power supply	230 V AC, +/- 10%
Max. power consumption	60 mA

Binary inputs	
Quantity	8
Type	NO contact
Input voltage	10V from internal power supply
Galvanic isolation	No
Dimensions and weight	
Dimensions	157 × 90 × 58mm
Weight	450g
Operating and installation conditions	
Operating temperature	-10 ÷ +55 °C
Storage temperature	-25 ÷ +70 °C
IP degree of protection acc. IEC 529	IP10B
Operating position	vertical
Type of operation	Continuous
Installation	on DIN rail
Connection terminals	Screw-type, removable
Cross-section of wires	Max. 2,5 / 4 mm ²

Binary outputs	
Quantity	19
Type	Switching relay
Switched voltage	Max. 250V AC, 30V DC, Min. 5V
Switched current	Max. 3A, min. 100mA, DO17-DO19 max. 16A
Galvanic isolation	Yes, even among groups, with the exception of COM7 and COM8
Current of the common terminal of the group	Max. 10A
Protection against inductive load	External (RC circuit, diode, varistor)

Analog inputs	
Quantity	3
Type of convertor	Approximation ,12 bit
Range of measurement	Pt1000 (-90/+320°C), Ni1000 (-60/+200°C), NTC12k (-40/+125°C), KTY81-121(-55/+125°C), OV600k (0 ÷ 630kΩ), OV6M (0 ÷ 6,5MΩ), 2V (0 ÷ 2,1V), 1V (0 ÷ 1,05V), 100mV (0 ÷ 105mV), 50mV (0 ÷ 52,5mV)
- resistor	
- voltage ^{*)}	
Error of input	3% of full range,

*) Available from version 1.5 of module firmware

3.14.1. Configuration

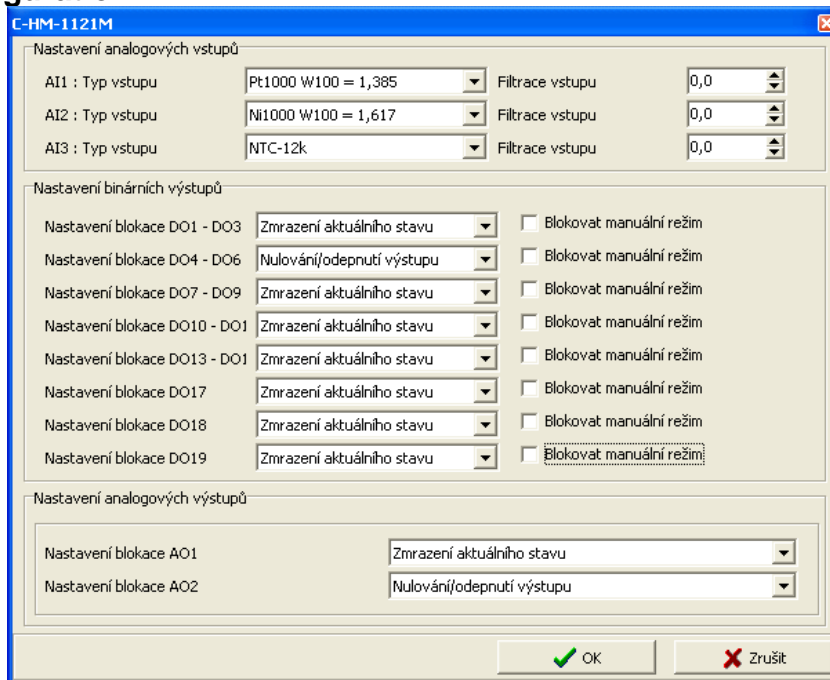

Fig. 3.11 Module configuration

Type of input

Choosing the type of analog input:

Pt1000, $W_{100} = 1,385$, -90/+320°C

Pt1000, $W_{100} = 1,391$, -90/+320°C

Ni1000, $W_{100} = 1,617$, -60/+200°C

Ni1000, $W_{100} = 1,500$, -60/+200°C

NTC 12k (negative thermistor, 12kΩ at 25°C), -40/+125°C

KTY 81-121, -55/+125°C

OV600k (0 ÷ 630kΩ)

OV6M (0 ÷ 6,5MΩ)

2V (0 ÷ 2,1V)

1V (0 ÷ 1,05V)

100mV (0 ÷ 105mV)

50mV (0 ÷ 50mV)

Input filtering

By specifying a non-zero value of the time constant, the 1st order digital filter is activated. The filter is given by

$$y_t = \frac{y_{t-1} \cdot \tau + x}{\tau + 1}$$

x - the current value of the analog input

y_t - output

y_{t-1} - recent output

τ -time constant of the 1st order filter (TAU)

Value of time constant is set in the range 0.1 ÷ 25.4 and it represents a time constant in the range of 100 ms ÷ 25.4 s (value 255 is intended for service purposes).

Blocking of DOx**Blocking of AOx**

It can be set for binary outputs (groups of binary outputs) DO and for analog outputs AO if they should stay in their last state or they should be disconnected during transition into HALT mode.

Blocking of manual mode

Checking the box the ability of manual control of binary outputs (group of binary outputs) in RUN mode is blocked. In the HALT mode the manual control of binary outputs is allowed always.

In RUN mode, the manual control is activated by pressing the button *MANUAL CONTROL* on module. At the same time the yellow indicator LED lights up *ON*. Then it is possible to change the status of each output by respective buttons. Another pressing the button *MANUAL CONTROL* LED indicator *ON* goes off and the manual mode is cancelled. Then binary outputs are controlled according to the commands of the CIB line. Activity of manual mode is also indicated in the module status variable *STAT.ManMode*.

3.14.2. The structure of the transmitted data

Module contains 5 devices in total:

- device 1, input, 1*STAT (status)
- device 2, input, 3*AI
- device 3, output, 2*AO
- device 4, input, 8*DI
- device 5, output, 19*DO

The devices are incorporated into the structure of the transmitted data, which is evident from window *I/O setting* in the Mosaic. Window is accessible by pressing the icon  in toolbar.

Struktura dat	Úplný zápis	Alias	Svorka	Abs./délka	Hodnota
[-] ID1_IN : TMI_CIB1_ID1_IN	MI_CIB1_IN~ID1_IN				
[-] STAT : TCIB_CHM0308_STAT	MI_CIB1_IN~ID1_IN~STAT			%R204 / 1	\$00
[-] AI : TCIB_AI3	MI_CIB1_IN~ID1_IN~AI				
[-] AI1 : REAL	MI_CIB1_IN~ID1_IN~AI~AI1			%RF205	0
[-] AI2 : REAL	MI_CIB1_IN~ID1_IN~AI~AI2			%RF209	0
[-] AI3 : REAL	MI_CIB1_IN~ID1_IN~AI~AI3			%RF213	0
[-] DI : TCIB_DI8	MI_CIB1_IN~ID1_IN~DI				\$00
[-] DI1 : BOOL	MI_CIB1_IN~ID1_IN~DI~DI1			%R217.0	0
[-] DI2 : BOOL	MI_CIB1_IN~ID1_IN~DI~DI2			%R217.1	0
[-] DI3 : BOOL	MI_CIB1_IN~ID1_IN~DI~DI3			%R217.2	0
[-] DI4 : BOOL	MI_CIB1_IN~ID1_IN~DI~DI4			%R217.3	0
[-] DI5 : BOOL	MI_CIB1_IN~ID1_IN~DI~DI5			%R217.4	0
[-] DI6 : BOOL	MI_CIB1_IN~ID1_IN~DI~DI6			%R217.5	0
[-] DI7 : BOOL	MI_CIB1_IN~ID1_IN~DI~DI7			%R217.6	0
[-] DI8 : BOOL	MI_CIB1_IN~ID1_IN~DI~DI8			%R217.7	0
[-] ID1_OUT : TMI_CIB1_ID1_OUT	MI_CIB1_OUT~ID1_OUT				
[-] AO : TCIB_AO2	MI_CIB1_OUT~ID1_OUT~AO				
[-] AO1 : REAL	MI_CIB1_OUT~ID1_OUT~AO~AO1			%RF218	0
[-] AO2 : REAL	MI_CIB1_OUT~ID1_OUT~AO~AO2			%RF222	0
[-] DOs : TCIB_DO19	MI_CIB1_OUT~ID1_OUT~DOs			%R226 / 3	

Fig. 3.12 The structure of the transmitted data

Input data

STAT	AI	DI
------	----	----

STAT - status byte of module (8x type bool)

	PowerErr	ManMode	VLD3	OUF3	VLD2	OUF2	VLD1	OUF1
Bit	.7	.6	.5	.4	.3	.2	.1	.0

- OUFx - overflow / underflow of analog input measurement
- VLDx - validity of reading of analog input AIx
- ManMode - signalling of manual control mode of binary outputs.
- PowerErr - supply voltage drop below the limit for guaranteed switching of relay outputs DO

AIx - value of analog inputs (3x type real) [°C] [kΩ] [MΩ] [mV]

DIx - value of binary inputs (8x type bool)

Output data

AO	DOs
----	-----

AOx - value of analog outputs (2x type real) [%]

DOx - value of binary outputs (19x type bool)

3.15. C-IB-1800M

The module contains a total of 18 binary inputs for potential-free normally open contacts. Each of these inputs can also be configured as an alarm input for security technology. Additionally four inputs can also be used either as the analog input for connection of resistive sensors or as the counter input for counting pulses from meters (standard interface S0 according to IEC 61393 / DIN 43864).

After connecting the module to the CIB line (power connected) the green RUN LED lights still. If the module is served by the CIB (it communicates), green RUN LED flashes regularly. The module can be powered from an external 24V DC source (not to overload CIB line). The module also provides power output 12V DC (supply security detectors etc.).

Mechanical design corresponds to the modular design with width of 4M for mounting on the DIN-rail.

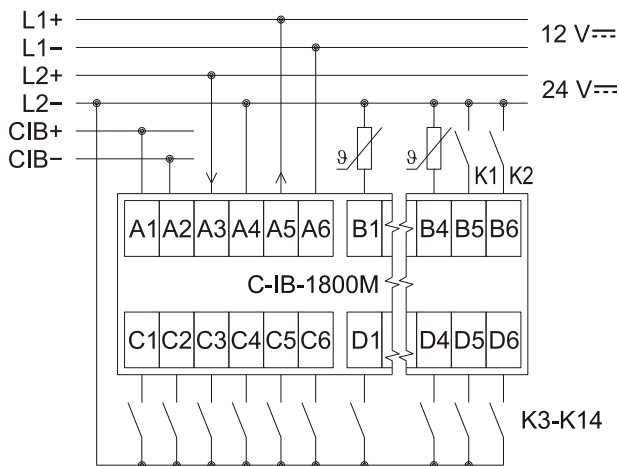
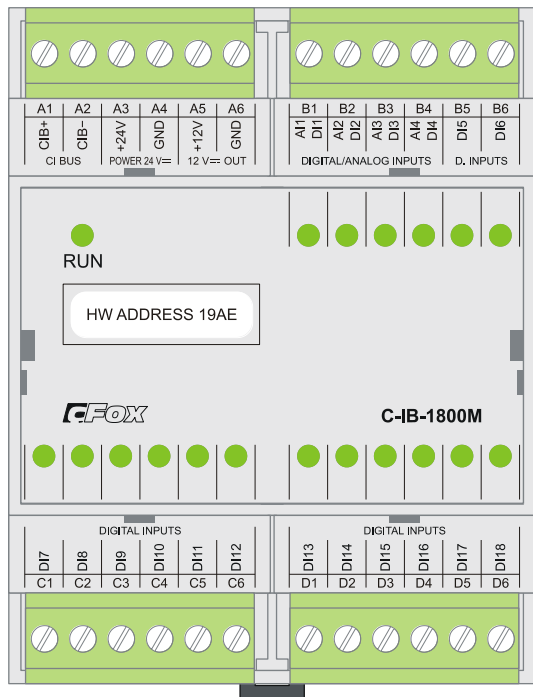

Fig. 3. 13 View and connection C-IB-1800M

Tab. 3.15 Basic parameters C-IB-1800M

Universal inputs DI/AI/EZS/COUNT (1 ÷ 4)	
Quantity	4
Optional input type	binary, analog, pulse counter, balanced inputs
Universal inputs DI/EZS (5 ÷ 18)	
Quantity	14
Optional input type	binary, balanced input
- Binary	
Type	NO contact (0/1) (Normally Open)
- Analog	
Pt1000	-90 ÷ +320 °C
Ni1000	-60 ÷ +200 °C
NTC 12kΩ	-40 ÷ +125 °C
KTY81-121	-55 ÷ +125 °C
Resistance input	0 ÷ 160 kΩ
Resolution, Accuracy	0.1 °C / 10Ω, 0.5 %
Period of refresh AI	typically 5s
- EZS - for security systems	
Simply balanced	Resistor in the loop 1 x 2k2
Double balanced	Resistor in the loop 2 x 1k1
- Pulse counter (standard interface S0, IEC 61393)	
Min. pulse width	30ms
Max. pulse frequency	20Hz
The period of reading	typically 5s
Power supply	
Power supply and communication	24 V (27 V) from the CIB
Max. power consumption from CIB line	140 mA
External power	24V DC, max. 230 mA
Power supply output	12V DC, max. 150 / 250mA ^{*)}
Dimensions and weight	
Dimensions	70 x 91 x 58 mm
Weight	160 g
Operating and installation conditions	
Operating temperature	-10 ÷ +55 °C
Storage temperature	-25 ÷ +70 °C
IP degree of protection acc. IEC 529	IP10B
Overvoltage category	II (according to EN 60664)
Degree of pollution	1 (according to EN 60664)
Operating position	arbitrary
Installation	on DIN rail
Connection terminals	Screw-type, removable
Cross-section of wires	Max. 2,5 mm ²

^{*)} 150mA supplying from CIB, 250mA supplying from external 24V

3.15. C-IB-1800M

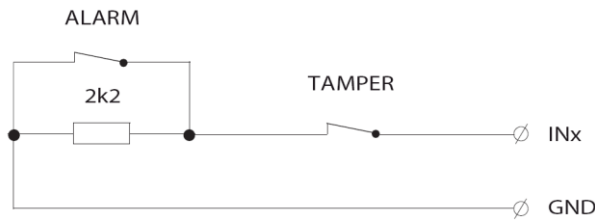

Fig. 3. 14 Simply balanced input for security detectors

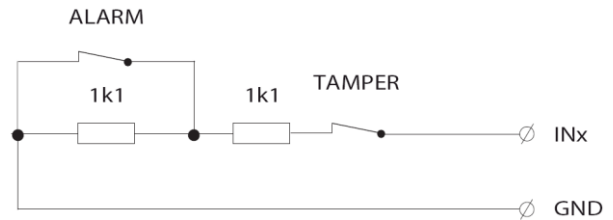

Fig. 3. 15 Double-balanced input for security detectors

3.15.1. Configuration

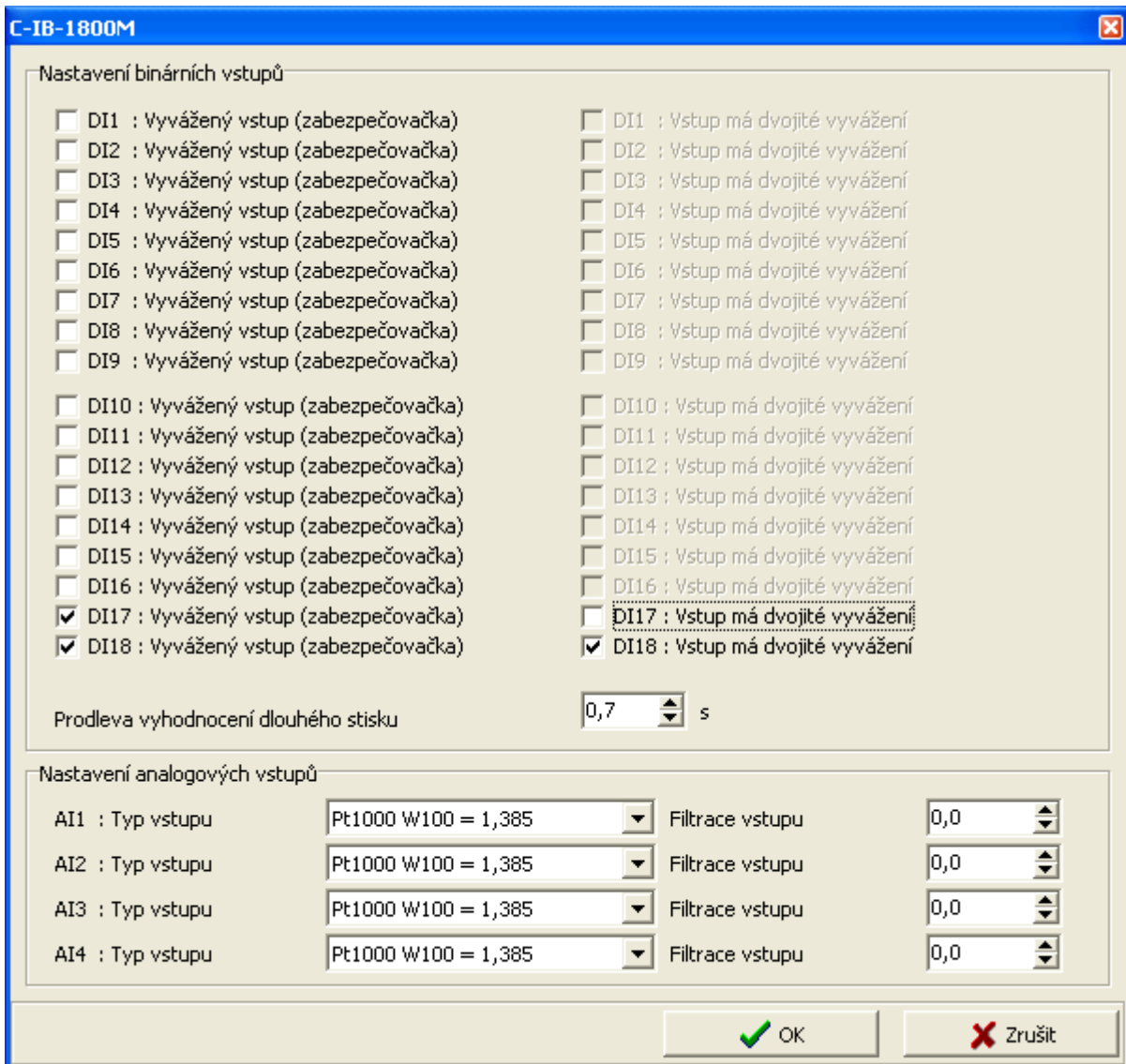

Fig. 3.16 Module configuration

The input terminals DI/AIx are **shared** for binary and analog inputs (for digital and analog equipment). As the input is configured as analog one, **it is not possible** use it as binary input **in the same time**. Depending on the configured input (as enabled devices) specific items of configuration dialog are enabled/disabled. Enabling devices see. chap.2.1 *Master configuration*, check the box *Show units, devices*

Balanced input

By checking the item, the respective input will be evaluated as a simple balanced binary alarm input. If the item is not checked, the respective input evaluated as a normal binary input (on/off).

Double balanced input

By checking the item, respective input will be evaluated as a double balanced binary alarm input. If the item is not checked and the input is configured for security systems (balanced input), the respective input evaluated as alarm input with a simple balance.

Delay, evaluation of long press

For binary (momentary button) inputs module directly evaluate the short and long presses on each input. By entering values one can set a delay time after which the activation of digital input DI is signalled as the long press (PRESS). Activating the digital input for period shorter than the entered value will be signalled by as the short press (CLICK). Delay period (T_{press}) can be inserted in the range $0.1 \div 2.5s$.

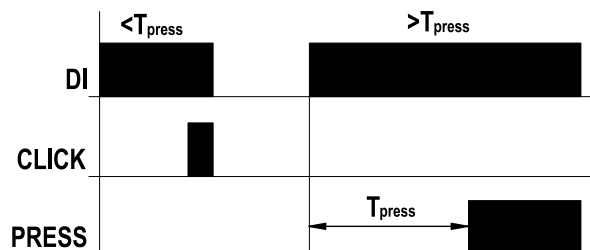

Fig. 3. 17 Evaluation of short / long press

Type of input

Choosing the type of analog input:

- Pt1000, $W_{100} = 1,385$, $-90/+320^{\circ}C$
- Pt1000, $W_{100} = 1,391$, $-90/+320^{\circ}C$
- Ni1000, $W_{100} = 1,617$, $-60/+200^{\circ}C$
- Ni1000, $W_{100} = 1,500$, $-60/+200^{\circ}C$
- NTC 12k (negative thermistor, $12k\Omega$ at $25^{\circ}C$), $-40/+125^{\circ}C$
- KTY 81-121, $-55/+125^{\circ}C$
- OV160k ($0 \div 160k\Omega$)
- 16-bit pulse counter, S0

Input filtering

By specifying a non-zero value of the time constant, the 1st order digital filter is activated. The filter is given by

$$y_t = \frac{y_{t-1} \cdot \tau + x}{\tau + 1}$$

x - the current value of the analog input

- y_t - output
- y_{t-1} - recent output
- τ -time constant of the 1st order filter (TAU)

Value of time constant is set in the range $0.1 \div 25.4$ and it represents a time constant in the range of $100 \text{ ms} \div 25.4 \text{ s}$ (value 255 is intended for service purposes).

3.15.1. The structure of the transmitted data

Module contains 6 devices in total:

- device 1, input, 18*DI/EZS
- device 2, input, 1*STAT (status)
- device 3, input, 1*AI (AI1)
- device 4, input, 1*AI (AI2)
- device 5, input, 1*AI (AI3)
- device 6, input, 1*AI (AI4)

The devices are incorporated into the structure of the transmitted data, which is evident from window *I/O setting* in the Mosaic. Window is accessible by pressing the icon  in toolbar.

Struktura dat	Úplný zápis	Alias	Svorka	Abs./délka	Hodnota
[-] ID1_IN : TMI_CIB1_ID1_IN	MI_CIB1_IN~ID1_IN				
[-] DI _s : TCIB_CIB1800M	MI_CIB1_IN~ID1_IN~DI _s				
[-] DI : TCIB_DI18	MI_CIB1_IN~ID1_IN~DI _s ~DI			%R4 / 3	
[-] CLICK : TCIB_CLICK18	MI_CIB1_IN~ID1_IN~DI _s ~CLICK			%R7 / 3	
[-] PRESS : TCIB_PRESS18	MI_CIB1_IN~ID1_IN~DI _s ~PRESS			%R10 / 3	
[-] TAMPER : TCIB_TAMPER	MI_CIB1_IN~ID1_IN~DI _s ~TAMPER			%R13 / 3	
[-] STAT : TCIB_AI4_STAT	MI_CIB1_IN~ID1_IN~STAT			%R16 / 1	\$00
AI1 : REAL	MI_CIB1_IN~ID1_IN~AI1			%RF17	0
AI2 : REAL	MI_CIB1_IN~ID1_IN~AI2			%RF21	0
AI3 : REAL	MI_CIB1_IN~ID1_IN~AI3			%RF25	0
AI4 : REAL	MI_CIB1_IN~ID1_IN~AI4			%RF29	0

Fig. 3.18 The structure of the transmitted data

Input data

DI _s	STAT	AI1	AI2	AI3	AI4
-----------------	------	-----	-----	-----	-----

DI_s.DI - current statuses of binary inputs (18x type bool)

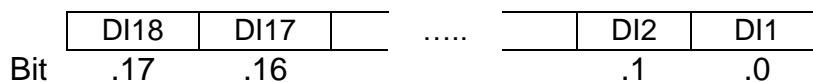

DI_x - Current status of binary input DI_x / alarm input x

DI_s.CLICK - current statuses of binary inputs (18x type bool)



CIB UNITS, MODULES

Bit
 .17 .16 .1 .0

CLICKx - short pulse (to log. 1) on binary input (button) x

Dis.PRESS - long presses on binary inputs (18x type bool)

PRESS18 PRESS17 PRESS2 PRESS1
Bit .17 .16 .1 .0

PRESSx - long pulse (into log. 1) on binary input (button) x

Dis.TAMPER - statuses of tamper at balanced inputs (18x type bool)

TAMPER18 TAMPER17 TAMPER2 TAMPER1
Bit .17 .16 .1 .0

TAMPERx - tamper status on balanced input x

STAT - status byte of analog inputs (8x type bool)

VLD4 OUF4 VLD3 OUF3 VLD2 OUF2 VLD1 OUF1
Bit .7 .6 .5 .4 .3 .2 .1 .0

OUFx - overflow / underflow of range of analog input Alx

VLDx - validity of reading of analog input Alx

A/1 - value of analog input A1/pulse counter 1 (type real) [°C],[kΩ]

A/2 - value of analog input A2/pulse counter 2 (type real) [°C],[kΩ]

A/3 - value of analog input A3/pulse counter 3 (type real) [°C],[kΩ]

A/4 - value of analog input A4/pulse counter 4 (type real) [°C],[kΩ]

The value of temperature sensor is transferred in °C (with resolution of 0.1°C), the value of general resistance in range 160kΩ is transferred in kΩ (with resolution of 10Ω). If the input is configured as the 16-bit pulse counter the value corresponds to the counter status (restart the module resets the counter value).

3.16. C-IR-0202S

The module includes one relay output, one analog output (0-10V) and 2 universal inputs. Each of the universal inputs can be used by either the binary input for potential free contacts or as a balanced input for alarm detectors (security systems) or as the analog input for connecting a resistance or temperature sensor.

The mechanical design of the module is designed to be mounted under cover of device (ingress protection of the module IP10B). Signals of the module are available on ribbon cable. Outputs of relay contacts are led out on two separate wires with increased insulation.

signalling green RUN LED is accessible from the side of module opposite to ribbon cable. Connecting on the CIB bus (connection to the power supply) is indicated by permanent lit of the RUN LED. Module operation on the CIB is indicated by regular flashing of the RUN LED.

For sensors Pt1000, Ni1000, KTY81-121, and sensor TC and TZ (thermistor NTC12k) module performs the conversion and linearization of measured values directly to temperature. For other types of resistors (in range 0 to 160 k Ω) the conversion to the temperature has to be done in user program in CPU (module gives the value in k Ω , with resolution 10 Ω).

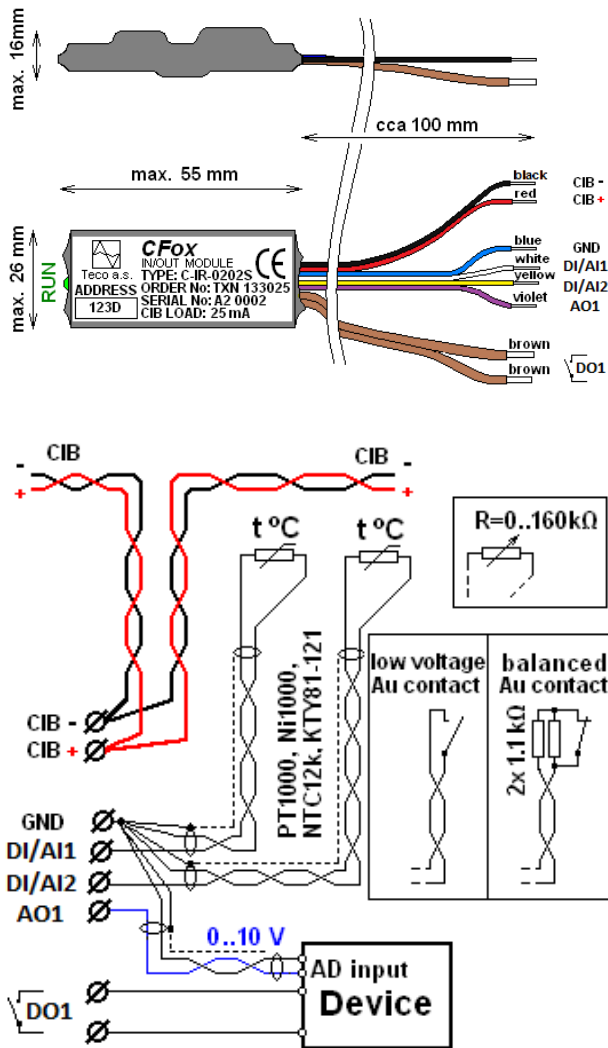

Fig. 3.19 View and connection C-IR-0202S

Tab. 3.16 Basic parameters C-IR-0202S

Universal inputs	
Quantity	2
Optional input type	Binary, balanced, Pt1000, Ni1000, NTC12kΩ, KTY81-121, resistance 160kΩ
Binary input	NO contact (0/1) (Normally Open)
Balanced input for security detectors	Resistance 1x2k2, or 2x1k1
Pt1000	-90 ÷ +320 °C
Ni1000	-60 ÷ +200 °C
NTC 12kΩ	-40 ÷ +125 °C
KTY81-121	-55 ÷ +125 °C
Resistance input	0 ÷ 160kΩ
Resolution, Accuracy	0.1 °C / 10Ω, 0.5%
Period of refresh AI	typically 5s
Binary relay output	
Type, contact material, max. current	normally open contact (NO), Ag-Ni, 5A
Max. switching power	750VA / 90W
Max. switched voltage	277VAC / 30VDC
Analog output	
Type, nominal voltage U_{im}	Voltage, 0 ÷ 10V
Adjustable range	0 ÷ 130% U_{im}
Minimal resolution	1%
Power supply	
Power supply and communication	24 V (27 V) from the CIB
Nominal/max. power consumption	18 / 25 mA
Galvanic isolation	Only output relay contact
Dimensions and weight	
Dimensions	max. 55 × 26 × 20mm
Weight	7 g
Operating and installation conditions	
Operating temperature	0 ÷ +55 °C
Storage temperature	-25 ÷ +70 °C
IP degree of protection acc. IEC 529	IP10B
Overvoltage category	II (according to EN 60664)
Degree of pollution	1 (according to EN 60664)
Operating position	arbitrary
Installation	
Type	under cover of device
Connecting	Ribbon cable 0.15 / 0.5mm ²

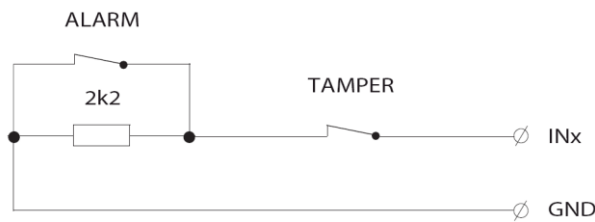

Fig. 3. 20 Simply balanced input for security detectors

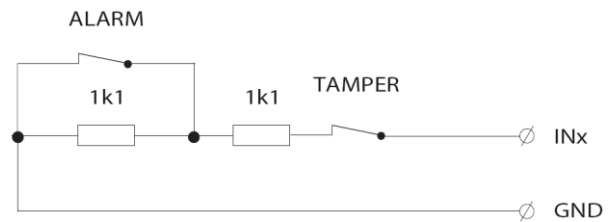

Fig. 3. 21 Double-balanced input for security detectors

3.16.1. Configuration

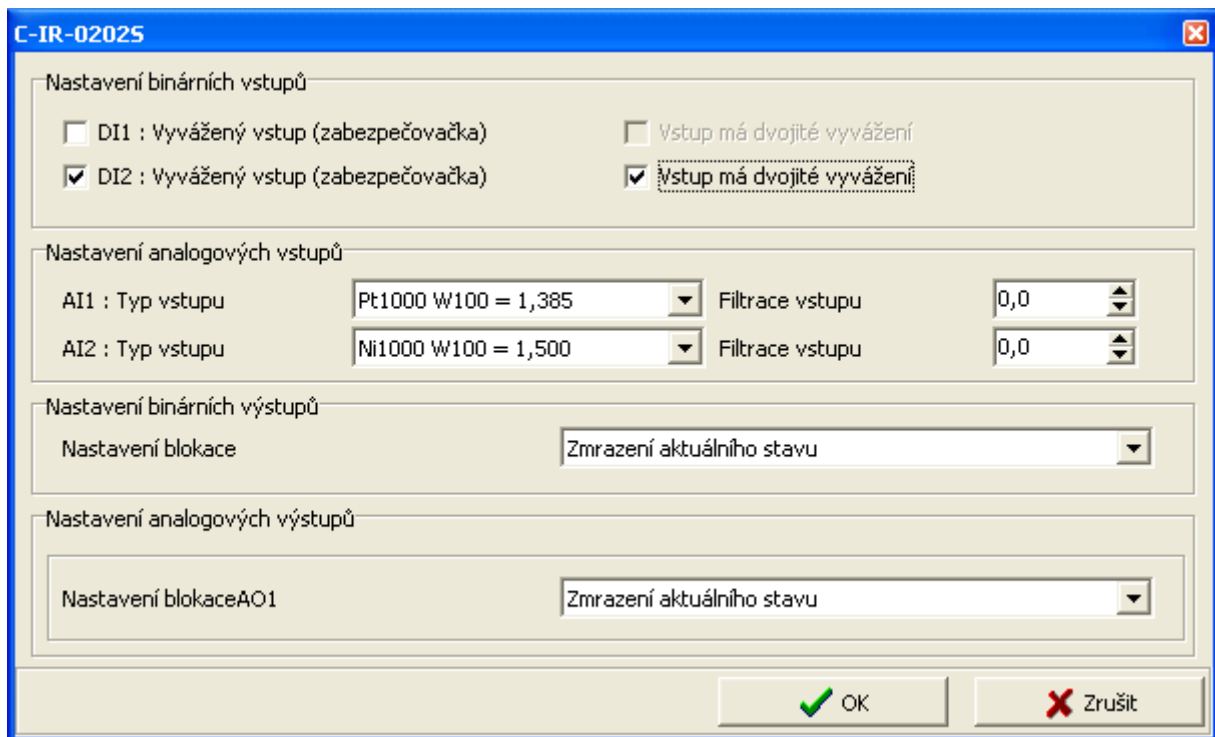

Fig. 3.22 Module configuration

The input terminals DI/AIx are **shared** for binary and analog inputs (for digital and analog equipment). As the input is configured as analog one, **it is not possible** use it as binary input **in the same time**. Depending on the configured input (as enabled devices) specific items of configuration dialog are enabled/disabled. Enabling devices see. chap. 2.1 *Master configuration*, check the box *Show units, devices*

Balanced input

By checking the item, the respective input will be evaluated as a simple balanced binary alarm input. If the item is not checked, the respective input evaluated as a normal binary input (on/off).

Double balanced input

By checking the item, respective input will be evaluated as a double balanced binary alarm input. If the item is not checked and the input is configured for security systems (balanced input), the respective input evaluated as alarm input with a simple balance.

Type of input

Choosing the type of analog input:

Pt1000, $W_{100} = 1,385$, -90/+320°C

Pt1000, $W_{100} = 1,391$, -90/+320°C

Ni1000, $W_{100} = 1,617$, -60/+200°C

Ni1000, $W_{100} = 1,500$, -60/+200°C

NTC 12k (negative thermistor, 12kΩ at 25°C), -40/+125°C

KTY 81-121, -55/+125°C

OV160k (0 ÷ 160kΩ)

Input filtering

By specifying a non-zero value of the time constant, the 1st order digital filter is activated. The filter is given by

$$y_t = \frac{y_{t-1} \cdot \tau + x}{\tau + 1}$$

- x - the current value of the analog input
- y_t - output
- y_{t-1} - recent output
- τ -time constant of the 1st order filter (TAU)

Value of time constant is set in the range 0.1 ÷ 25.4 and it represents a time constant in the range of 100 ms ÷ 25.4 s (value 255 is intended for service purposes).

Blocking of DO1

Blocking of AO1

It can be set for binary outputs and for analog output AO1 if they should stay in their last state or they should be disconnected during transition into HALT mode.

3.16.2. The structure of the transmitted data

Module contains 5 devices in total:

- device 1, input/output, 2*DI, EZS/1*DO
- device 2, output, 1*AO
- device 3, input, 1*STAT (status AIx)
- device 4, input, 1*AI (input AI1)
- device 5, input, 1*AI (input AI2)

The devices are incorporated into the structure of the transmitted data, which is evident from window *I/O setting* in the Mosaic. Window is accessible by pressing the icon  in toolbar.

Struktura dat	Úplný zápis	Alias	Svorka	Abs./délka	Hodnota
Statistic_MI_CIB1 : TCHStatistic	r0_p2_Statistic_MI_CIB1			%X0 / 10	
Control_MI_CIB1 : TCHControl	r0_p2_Control_MI_CIB1			%Y0 / 2	\$0000
ID1_IN : TMI_CIB1_ID1_IN	MI_CIB1_IN~ID1_IN				
DI : TCIB_DI2T	MI_CIB1_IN~ID1_IN~DI				\$00
DI1 : BOOL	MI_CIB1_IN~ID1_IN~DI~DI1			%R204.0	0
DI2 : BOOL	MI_CIB1_IN~ID1_IN~DI~DI2			%R204.1	0
TAMPER1 : BOOL	MI_CIB1_IN~ID1_IN~DI~TAMPER1			%R204.4	0
TAMPER2 : BOOL	MI_CIB1_IN~ID1_IN~DI~TAMPER2			%R204.5	0
STAT : TCIB_AI2_STAT	MI_CIB1_IN~ID1_IN~STAT				\$00
OUF1 : BOOL	MI_CIB1_IN~ID1_IN~STAT~OUF1			%R205.0	0
VLD1 : BOOL	MI_CIB1_IN~ID1_IN~STAT~VLD1			%R205.1	0
OUF2 : BOOL	MI_CIB1_IN~ID1_IN~STAT~OUF2			%R205.2	0
VLD2 : BOOL	MI_CIB1_IN~ID1_IN~STAT~VLD2			%R205.3	0
AI1 : REAL	MI_CIB1_IN~ID1_IN~AI1			%RF206	0
AI2 : REAL	MI_CIB1_IN~ID1_IN~AI2			%RF210	0
ID1_OUT : TMI_CIB1_ID1_OUT	MI_CIB1_OUT~ID1_OUT				
DO1 : BOOL	MI_CIB1_OUT~ID1_OUT~DO1			%R222.0	0
AO1 : REAL	MI_CIB1_OUT~ID1_OUT~AO1			%RF223	0

Fig. 3.23 The structure of the transmitted data

Input data

DI	STAT	AI1	AI2
----	------	-----	-----

DI - status of binary inputs, signalling "tamper" status of alarm inputs (8x type bool)

	-	-	TAMPER2	TAMPER1	-	-	DI2	DI1
Bit	.7	.6	.5	.4	.3	.2	.1	.0

- DI1 - the current status of the binary DI1/balanced for alarm input1
- DI2 - the current status of the binary DI2/balanced for alarm input 2
- TAMPER1 - tamper status on balanced input 1
- TAMPER2 - tamper status on balanced input 2

STAT - status byte of analog inputs (8x type bool)

	-	-	-	-	VLD2	OUF2	VLD1	OUF1
Bit	.7	.6	.5	.4	.3	.2	.1	.0

- OUF1 - overflow / underflow of range of analog input AI1
- VLD1 - AI1 analog input reading validity
- OUF2 - overflow / underflow of range of analog input AI2
- VLD2 - AI2 analog input reading validity

AI1 - value of analog input AI1 (type real) [°C],[kΩ]

AI2 - value of analog input AI2 (type real) [°C],[kΩ]
The value of temperature sensor is transferred in °C (with resolution of 0.1°C), the value of general resistance in range 160kΩ is transferred in kΩ (with resolution of 10Ω).

Output data

DO1	AO1
-----	-----

DO1 - status of binary output (type bool)

AO1 - value of analog output (type real) [0-100%]

3.17. C-IR-0203M

The module includes two relay outputs, one analog output (PWM/0-10V) and 2 universal inputs. Each of the universal inputs can be used by either the binary input for potential free contacts or as a balanced input for alarm detectors (security systems) or as the analog input for resistance or temperature sensors.

Analog inputs are configurable according to the type of sensor. Mode of analog / PWM output is configurable by the switch on the module. Relay outputs allow local manual control by buttons on the module. Mechanical design corresponds to the modular design with width of 1.5M for mounting on the DIN-rail.

There is signalling green RUN LED on top of the module. Connecting on the CIB bus (connection to the power supply) is indicated by permanent lit of the RUN LED. Module operation on the CIB is indicated by regular flashing of the RUN LED.

Tab. 3.17 Basic parameters C-IR-0203S

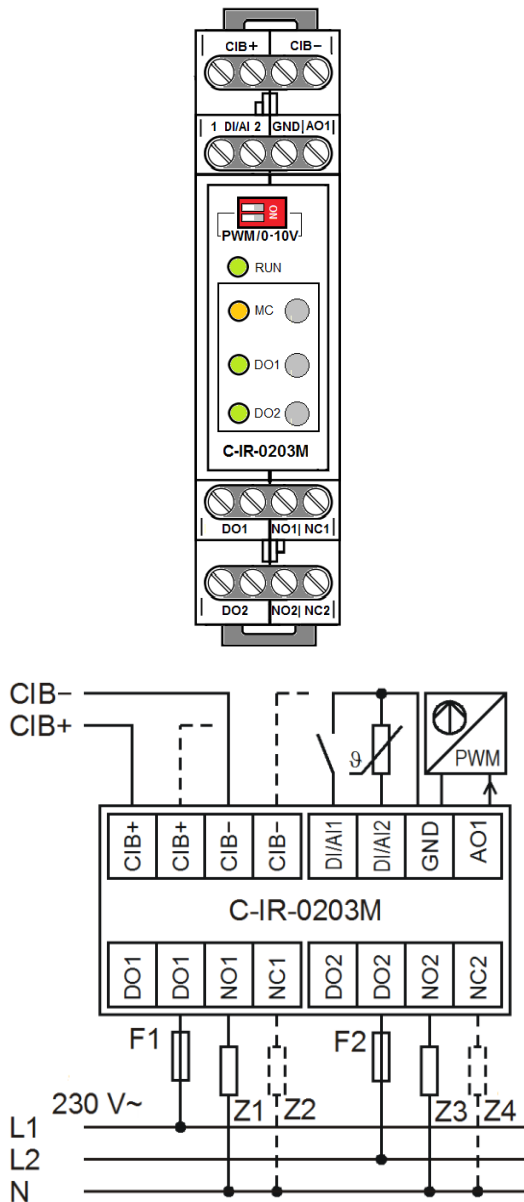

Fig. 3.24 View and connection C-IR-0203M

Universal inputs		
Quantity	2	
Optional input type	Binary (button), balanced, Pt1000, Ni1000, NTC12kΩ, KTY81-121, resistance 160kΩ	
Binary input	NO contact (0/1) (Normally Open)	
Balanced input for security detectors	Resistance 1x2k2, or 2x1k1	
Pt1000	-90 ÷ +320 °C	
Ni1000	-60 ÷ +200 °C	
NTC 12kΩ	-40 ÷ +125 °C	
KTY81-121	-55 ÷ +125 °C	
Resistance input	0 ÷ 160kΩ	
Resolution, Accuracy	0.1 °C / 10Ω, 0.5 %	
Period of refresh AI	typically 5s	
Binary relay output		
Type	changeover contacts	
Max. switched voltage	300V AC / 300V DC (min.5V)	
Switched current max.	16A/10A NO/NC (min.100mA)	
Max. switching power	4000VA / 384W	
Analog output		
Mode	Analog	PWM
Nominal voltage/amplitude	10V ±2%	10 ÷ 24V ±2%
The repetition frequency	-	100 ÷ 2000Hz
Adjustable range	0 ÷ 100% U _{im}	
Minimal resolution	1%	
Power supply		
Power supply and communication	24 V (27 V) from the CIB	
Max. power consumption	60 mA	
Galvanic isolation	Only output relay contact	
Dimensions and weight		
Dimensions	105 × 90 × 22mm	
Weight	95 g	
Operating and installation conditions		
Operating temperature	0 ÷ +55 °C	
Storage temperature	-25 ÷ +70 °C	
IP degree of protection acc. IEC 529	IP10B	
Overvoltage category	II (according to EN 60664)	
Degree of pollution	1 (according to EN 60664)	
Operating position	vertical	
Installation		
Connection terminals	Screw-type	
Cross-section of wires	Max. 2,5 mm ²	

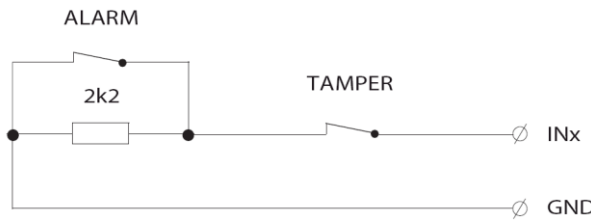

Fig. 3. 25 Simply balanced input for security detectors

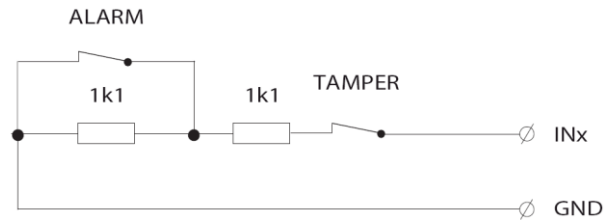

Fig. 3. 26 Double-balanced input for security detectors

3.17.1. Configuration

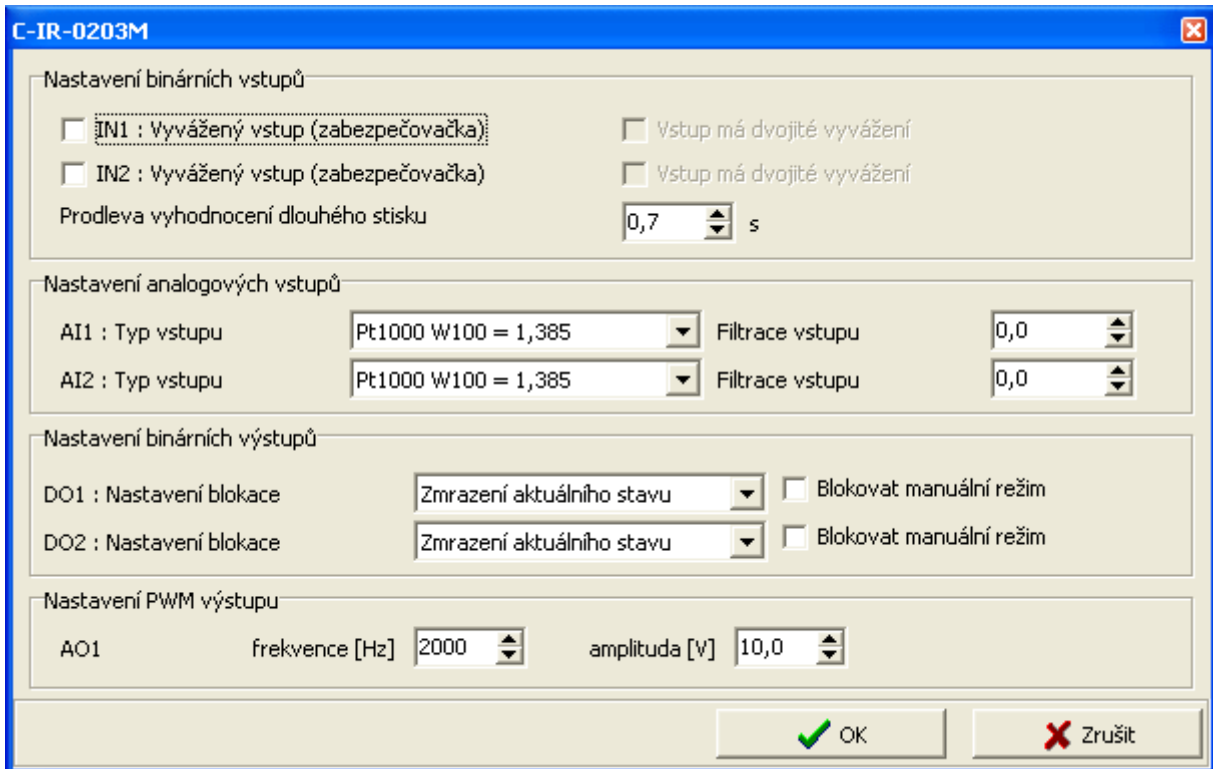

Fig. 3.27 Module configuration

The input terminals DI/AIx are **shared** for binary and analog inputs (for digital and analog equipment). As the input is configured as analog one, **it is not possible** use it as binary input **in the same time**. Depending on the configured input (as enabled devices) specific items of configuration dialog are enabled/disabled. Enabling devices see. chap. 2.1 *Master configuration*, check the box *Show units, devices*

The analog output can be operated in either an analog voltage output, or PWM output mode. The PWM mode is set by HW switch on the front panel of the module (always switch the both independent switches). Switch status is indicated in the status variable of module *STAT.PWM*.

Balanced input

By checking the item, the respective input will be evaluated as a simple balanced binary alarm input. If the item is not checked, the respective input evaluated as a normal binary input (on/off).

Double balanced input

By checking the item, respective input will be evaluated as a double balanced binary alarm input. If the item is not checked and the input is configured for security systems (balanced input), the respective input evaluated as alarm input with a simple balance.

Delay, evaluation of long press

For binary (momentary button) inputs module directly evaluate the short and long presses on each input. By entering values one can set a delay time after which the activation of digital input DI is signalled as the long press (PRESS). Activating the digital input for period shorter than the entered value will be signalled as the short press (CLICK). Delay period (T_{press}) can be inserted in the range $0.1 \div 2.5s$.

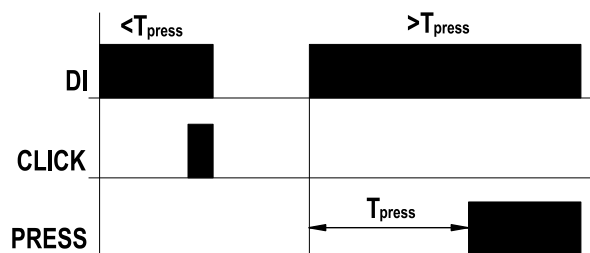

Fig. 3. 28 Evaluation of short / long press

Type of input

Choosing the type of analog input:

Pt1000, $W_{100} = 1,385$, $-90/+320^{\circ}C$

Pt1000, $W_{100} = 1,391$, $-90/+320^{\circ}C$

Ni1000, $W_{100} = 1,617$, $-60/+200^{\circ}C$

Ni1000, $W_{100} = 1,500$, $-60/+200^{\circ}C$

NTC 12k (negative thermistor, $12k\Omega$ at $25^{\circ}C$), $-40/+125^{\circ}C$

KTY 81-121, $-55/+125^{\circ}C$

OV160k ($0 \div 160k\Omega$)

Input filtering

By specifying a non-zero value of the time constant, the 1st order digital filter is activated. The filter is given by

$$y_t = \frac{y_{t-1} \cdot \tau + x}{\tau + 1}$$

- x - the current value of the analog input
- y_t - output
- y_{t-1} - recent output
- τ -time constant of the 1st order filter (TAU)

Value of time constant is set in the range $0.1 \div 25.4$ and it represents a time constant in the range of $100 \text{ ms} \div 25.4 \text{ s}$ (value 255 is intended for service purposes).

Blocking of DO

It can be set for binary outputs if they should stay in their last state or they should be disconnected during transition into HALT mode.

Blocking of manual mode

The ability of manual control of specific binary outputs in the RUN mode is blocked by checking the box. In the HALT mode the manual control of LED outputs is allowed always.

In RUN mode, the manual control is activated by pressing the button *MC (Manual Control)* on module. At the same time the yellow indicator LED MC lights up. Then it is possible to change the status of each output by respective buttons. Another pressing the button *MANUAL CONTROL* LED indicator *MC* goes off and the manual mode is cancelled. Then binary outputs are controlled according to the commands of the CIB line. Activity of manual mode is also indicated in the module status variable *STAT.MAN*.

Setting of PWM output

The analog output will work in PWM mode by setting the switch into position *PWM*. For this output the PWM frequency can be set in range of 100Hz to 2kHz and nominal voltage level in range of 10V to 24V.

The analog output will work in voltage output mode 0÷10V, if the switch will be set into the position *0-10V*.

3.17.2. The structure of the transmitted data

Module contains 6 devices in total:

- device 1, input, 2*DI/EZS
- device 2, output, 2*DO
- device 3, input, 1*STAT (status AIx)
- device 4, input, 1*AI (input AI1)
- device 5, input, 1*AI (input AI2)
- device 6, output, 1*AO (output AO/PWM)

The devices are incorporated into the structure of the transmitted data, which is evident from window *I/O setting* in the Mosaic. Window is accessible by pressing the icon  in toolbar.

CIB UNITS, MODULES

Struktura dat	Úplný zápis	Alias	Svorka	Abs./délka	Hodnota
ID1_IN : TMI_CIB1_ID1_IN	MI_CIB1_IN~ID1_IN				
DI : TCIB_CIR0203_DI	MI_CIB1_IN~ID1_IN~DI				
DI1 : BOOL	MI_CIB1_IN~ID1_IN~DI~DI1			%R4.0	0
DI2 : BOOL	MI_CIB1_IN~ID1_IN~DI~DI2			%R4.1	0
CLICK1 : BOOL	MI_CIB1_IN~ID1_IN~DI~CLICK1			%R4.2	0
CLICK2 : BOOL	MI_CIB1_IN~ID1_IN~DI~CLICK2			%R4.3	0
PRESS1 : BOOL	MI_CIB1_IN~ID1_IN~DI~PRESS1			%R4.4	0
PRESS2 : BOOL	MI_CIB1_IN~ID1_IN~DI~PRESS2			%R4.5	0
TAMPER1 : BOOL	MI_CIB1_IN~ID1_IN~DI~TAMPER1			%R4.6	0
TAMPER2 : BOOL	MI_CIB1_IN~ID1_IN~DI~TAMPER2			%R4.7	0
STAT : TCIB_CIR0203_STAT	MI_CIB1_IN~ID1_IN~STAT				\$00
OUF1 : BOOL	MI_CIB1_IN~ID1_IN~STAT~OUF1			%R5.0	0
VLD1 : BOOL	MI_CIB1_IN~ID1_IN~STAT~VLD1			%R5.1	0
OUF2 : BOOL	MI_CIB1_IN~ID1_IN~STAT~OUF2			%R5.2	0
VLD2 : BOOL	MI_CIB1_IN~ID1_IN~STAT~VLD2			%R5.3	0
PWM : BOOL	MI_CIB1_IN~ID1_IN~STAT~PWM			%R5.6	0
MAN : BOOL	MI_CIB1_IN~ID1_IN~STAT~MAN			%R5.7	0
A11 : REAL	MI_CIB1_IN~ID1_IN~A11			%RF6	0
A12 : REAL	MI_CIB1_IN~ID1_IN~A12			%RF10	0
ID1_OUT : TMI_CIB1_ID1_OUT	MI_CIB1_OUT~ID1_OUT				
DOs : TCIB_DO2	MI_CIB1_OUT~ID1_OUT~DOs				\$00
DO1 : BOOL	MI_CIB1_OUT~ID1_OUT~DOs~DO1			%R14.0	0
DO2 : BOOL	MI_CIB1_OUT~ID1_OUT~DOs~DO2			%R14.1	0
AO1 : REAL	MI_CIB1_OUT~ID1_OUT~AO1			%RF15	0

Fig. 3.29 The structure of the transmitted data

Input data

DI	STAT	AI1	AI2
----	------	-----	-----

DI - status of binary inputs, signalling "tamper" status of alarm inputs (8x type bool)

	TAMPER2	TAMPER1	PRESS2	PRESS1	CLICK2	CLICK1	DI2	DI1
Bit	.7	.6	.5	.4	.3	.2	.1	.0

DIx - Current status of binary input DIx / alarm input x

CLICKx - short pulse (to log. 1) on binary input (button) x

PRESSx - long pulse (into log. 1) on binary input (button) x

TAMPERx - tamper status on balanced input x

STAT - status byte of analog inputs (8x type bool)

	MAN	PWM	-	-	VLD2	OUF2	VLD1	OUF1
Bit	.7	.6	.5	.4	.3	.2	.1	.0

OUF1 - overflow / underflow of range of analog input AI1

VLD1 - AI1 analog input reading validity

OUF2 - overflow / underflow of range of analog input AI2

VLD2 - AI2 analog input reading validity

PWM - state of HW switch of mode of AO1

= 0 - switch in position 0-10V (analog output)

= 1 - switch in position PWM (PWM output)

MAN - signalling of manual mode of relay outputs.

- A11* - value of analog input AI1 (type real) [°C],[kΩ]
A12 - value of analog input AI2 (type real) [°C],[kΩ]
 The value of temperature sensor is transferred in °C (with resolution of 0.1°C), the value of general resistance in range 160kΩ is transferred in kΩ (with resolution of 10Ω).

Output data

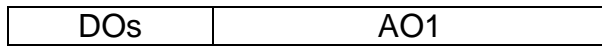

- DOx* - value of binary outputs (8x type bool)

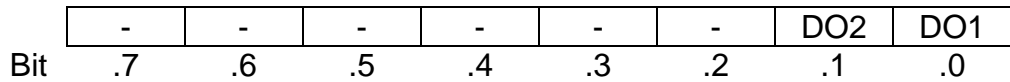

- DO1* - value of binary output DO1
DO2 - value of binary output DO2

- AO1* - value of analog/PWM output (type real) [0÷100%]

3.18. C-IT-0100H-A

Module temperature sensor in the metal head is designed to temperature measurement in the immersion tube. It contains 2 temperature sensors. The first one is located in the end of the metal stem (main sensor) and is used primary for temperature measurement. The second sensor is placed in the metal head (auxiliary sensor) and is intended for information about the operating temperature of the module head.

After removing the cap of the head CIB connection terminals and signalling RUN LED are accessible. Connecting on the CIB bus (connection to the power supply) is indicated by permanent lit of the RUN LED. Module operation on the CIB is indicated by regular flashing of the RUN LED.

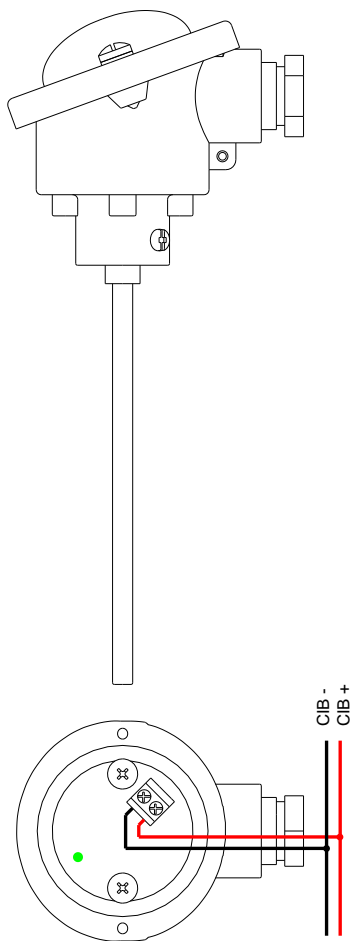

Fig. 3. 30 View and connection example C-IT-0100H-A

Tab. 3.18 Basic parameters C-IT-0100H-A

Temperature inputs	
Quantity	2
Sensor type in the stem	Pt1000, $W_{100} = 1,385$
Range	$-90 \div +320 \text{ }^{\circ}\text{C}$
Resolution	$0.1 \text{ }^{\circ}\text{C}$
Accuracy	$0.5 \text{ }^{\circ}\text{C}$
Temperature settling time	30 min.
Sensor type in the head	Thermistor NTC 12k
Power supply	
Power supply and communication	24 V (27 V) from the CIB
Nominal power consumption	8 mA
Galvanic isolation	No
Dimensions and weight	
Dimensions	$90 \times 71 \times 200\text{mm}$
Length of the stem	125 mm
Weight	220 g
Operating and installation conditions	
Operating temperature	$-25 \div +70 \text{ }^{\circ}\text{C}$
Storage temperature	$-25 \div +80 \text{ }^{\circ}\text{C}$
IP degree of protection acc. IEC 529	IP 54
Overvoltage category EN 60664	II
Degree of pollution EN 60664	1
Operating position	arbitrary
Installation	
Connecting	screw type terminals
Cross-section of wires	max. $1,0 \text{ mm}^2$

3.18.1. Configuration

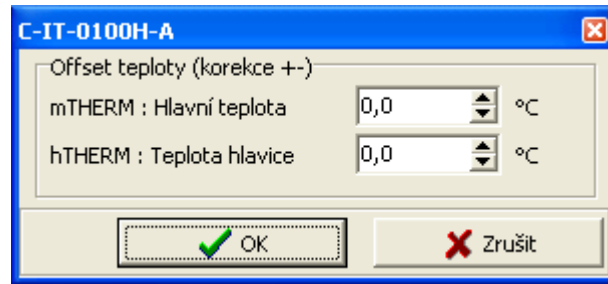

Fig. 3.31 Module configuration

Temperature offset

Correction offset of thermometer, which will be added on the measured temperature.

3.18.2. The structure of the transmitted data

Module contains 3 devices in total:

- device 1, input, 1*STAT (status)
- device 2, input, 1*AI (thermometer in the stem)
- device 3, input, 1*AI (thermometer in the head)

The devices are incorporated into the structure of the transmitted data, which is evident from window *I/O setting* in the Mosaic. Window is accessible by pressing the icon  in toolbar.

Struktura dat	Úplný zápis	Alias	Svorka	Abs./délka	Hodnota
Statistic_MI_CIB1 : TCHStatistic	r0_p2_Statistic_MI_CIB1			%X0 / 10	
Control_MI_CIB1 : TCHControl	r0_p2_Control_MI_CIB1			%Y0 / 2	\$0000
ID1_IN : TMI_CIB1_ID1_IN	MI_CIB1_IN~ID1_IN				
STAT : TCIB_CIT0100_STAT	MI_CIB1_IN~ID1_IN~STAT				\$00
mOUF : BOOL	MI_CIB1_IN~ID1_IN~STAT~mOUF			%R204.0	0
mVLD : BOOL	MI_CIB1_IN~ID1_IN~STAT~mVLD			%R204.1	0
hOUF : BOOL	MI_CIB1_IN~ID1_IN~STAT~hOUF			%R204.2	0
hVLD : BOOL	MI_CIB1_IN~ID1_IN~STAT~hVLD			%R204.3	0
mTHERM : REAL	MI_CIB1_IN~ID1_IN~mTHERM			%RF205	0
hTHERM : REAL	MI_CIB1_IN~ID1_IN~hTHERM			%RF209	0

Fig. 3.32 The structure of the transmitted data

Input data

STAT	mTHERM	hTHERM
------	--------	--------

STAT - status byte (8x type bool)

	-	-	-	-	hVLD	hOUF	mVLD	mOUF
Bit	.7	.6	.5	.4	.3	.2	.1	.0

- mOUF - overflow/underflow of the range of primary temperature sensor
- mVLD - validity of the reading of primary temperature sensor
- hOUF - overflow/underflow of the range of auxiliary temperature sensor
- hVLD - validity of the reading of auxiliary temperature sensor

mTHERM - temperature of primary sensor in the stem (type real) [°C]

hTHERM - temperature of primary sensor, in the head (type real) [°C]

3.19. C-IT-0100H-P

Module temperature sensor in the plastic head (with higher ingress protection - IP) is designed to temperature measurement in the immersion tube. It contains 2 temperature sensors. The first one is located in the end of the metal stem (primary sensor) and is used primary for temperature measurement. The second sensor is placed in the plastic head (auxiliary sensor) and is intended for information about the operating temperature of the module head.

After removing the cap of the head CIB connection terminals and signalling RUN LED are accessible. Connecting on the CIB bus (connection to the power supply) is indicated by permanent lit of the RUN LED. Module operation on the CIB is indicated by regular flashing of the RUN LED.

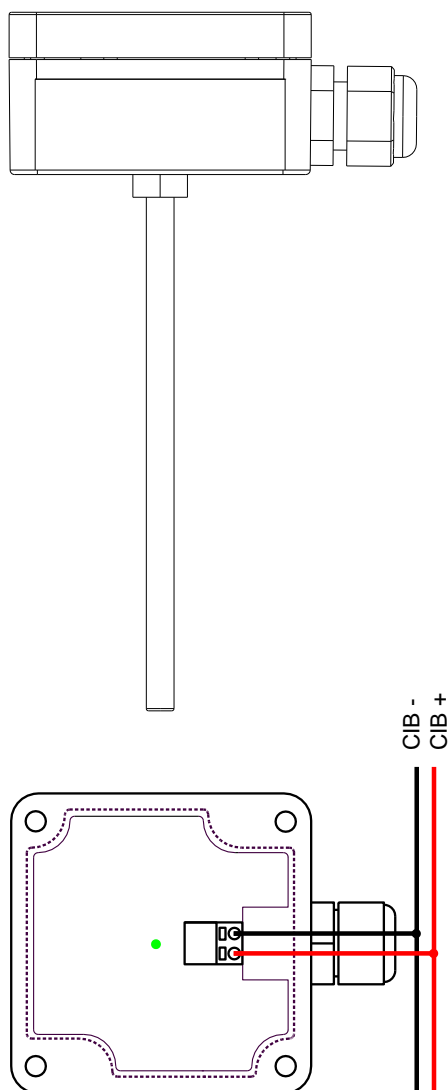

Tab. 3.19 Basic parameters C-IT-0100H-P

Temperature inputs	
Quantity	2
Sensor type in the stem	Pt1000, $W_{100} = 1,385$
Range	$-90 \div +320 \text{ }^{\circ}\text{C}$
Resolution	$0.1 \text{ }^{\circ}\text{C}$
Accuracy	$0.5 \text{ }^{\circ}\text{C}$
Temperature settling time	30 min.
Sensor type in the head	Thermistor NTC 12k
Power supply	
Power supply and communication	24 V (27 V) from the CIB
Nominal power consumption	8 mA
Galvanic isolation	No
Dimensions and weight	
Dimensions	$90 \times 66 \times 155\text{mm}$
Length of the stem	115 mm
Weight	130 g
Operating and installation conditions	
Operating temperature	$-25 \div +70 \text{ }^{\circ}\text{C}$
Storage temperature	$-25 \div +80 \text{ }^{\circ}\text{C}$
IP degree of protection acc. IEC 529	IP 65
Overvoltage category EN 60664	II
Degree of pollution EN 60664	1
Operating position	arbitrary
Installation	
Connecting	Push-in terminals,
Cross-section of wires	max. $1,0 \text{ mm}^2$

Fig. 3.33 View and connection example C-IT-0100H-P

3.19.1. Configuration

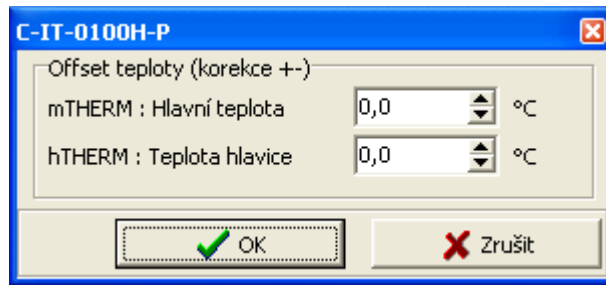

Fig. 3.34 Module configuration

Temperature offset

Correction offset of thermometer, which will be added on the measured temperature.

3.19.2. The structure of the transmitted data

Module contains 3 devices in total:

- device 1, input, 1*STAT (status)
- device 2, input, 1*AI (thermometer in the stem)
- device 3, input, 1*AI (thermometer in the head)

The devices are incorporated into the structure of the transmitted data, which is evident from window *I/O setting* in the Mosaic. Window is accessible by pressing the icon  in toolbar.

Struktura dat	Úplný zápis	Alias	Svorka	Abs./délka	Hodnota
Statistic_MI_CIB1 : TCHStatistic	r0_p2_Statistic_MI_CIB1			%X0 / 10	
Control_MI_CIB1 : TCHControl	r0_p2_Control_MI_CIB1			%Y0 / 2	\$0000
ID1_IN : TMI_CIB1_ID1_IN	MI_CIB1_IN~ID1_IN				
STAT : TCIB_CIT0100_STAT	MI_CIB1_IN~ID1_IN~STAT				\$00
mOUF : BOOL	MI_CIB1_IN~ID1_IN~STAT~mOUF			%R204.0	0
mVLD : BOOL	MI_CIB1_IN~ID1_IN~STAT~mVLD			%R204.1	0
hOUF : BOOL	MI_CIB1_IN~ID1_IN~STAT~hOUF			%R204.2	0
hVLD : BOOL	MI_CIB1_IN~ID1_IN~STAT~hVLD			%R204.3	0
mTHERM : REAL	MI_CIB1_IN~ID1_IN~mTHERM			%RF205	0
hTHERM : REAL	MI_CIB1_IN~ID1_IN~hTHERM			%RF209	0

Fig. 3.35 The structure of the transmitted data

Input data

STAT	mTHERM	hTHERM
------	--------	--------

STAT - status byte (8x type bool)

	-	-	-	-	hVLD	hOUF	mVLD	mOUF
Bit	.7	.6	.5	.4	.3	.2	.1	.0

- mOUF - overflow/underflow of the range of primary temperature sensor
- mVLD - validity of the reading of primary temperature sensor
- hOUF - overflow/underflow of the range of auxiliary temperature sensor
- hVLD - validity of the reading of auxiliary temperature sensor

mTHERM - temperature of primary sensor in the stem (type real) [°C]

hTHERM - temperature of primary sensor, in the head (type real) [°C]

3.20. C-IT-0200I

Module contains 2 analog inputs and one internal temperature sensor. Each analog input can be configured independently for temperature sensors, thermocouples, resistors, voltage or current.

Module is designed into the plastic box with the higher ingress protection IP65.

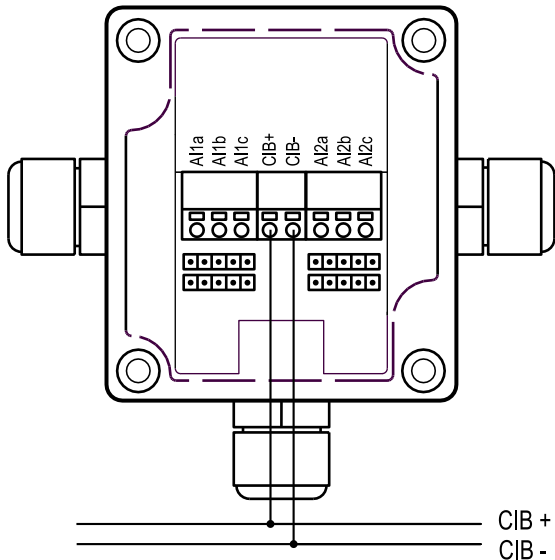

Fig. 3.36 View C-IT-0200I

Power supply	
Power supply and communication	24 V (27 V) from the CIB
Max. power consumption	15mA, 60mA (at powering the current loops)
Galvanic isolation	No
Dimensions and weight	
Dimensions	125 × 100 × 38mm
Weight	120 g
Operating and installation conditions	
Operating temperature	-10 ÷ +55 °C
Storage temperature	-25 ÷ +70 °C
IP degree of protection acc. IEC 529	IP65
Operating position	arbitrary
Installation	
Type	wall mounting
Connecting	Push-in terminals,
Cross-section of wires	0,14 ÷ 1,5 mm ²

Tab. 3.20 Basic parameters C-IT-0200I

Analog inputs	
Quantity	2
Type of convertor	Sigma-delta, 16 bits
Range of measurement	
- Resistor	Pt1000 (-90/+320°C), Ni1000 (-60/+200°C), NTC12k/25°C(-40/+125°C), KTY81-121 (-55/+125°C), OV200k (0 ÷ 200kΩ),
- Voltage	0÷10V, 0÷5V, ±2V, ±1V, High Impedance ±1V, High Impedance ±100mV,
- Current	0÷20mA, 4÷20mA,
- Thermocouples	type J (-210/+1200°C), type K (-200/+1372°C), type R (-50/+1768°C), type S (-50/+1768°C), type T (+200/+400°C), type B (+250/+1820°C), type N (-200/+1300°C)
Input impedance	4.7kΩ
- RTD, NTC, OV	54.6 kΩ
- Voltage ranges	4MΩ
- Thermocouples, High impedance voltage ranges	50Ω
- Current ranges	
Measurement error	< 2% < 5% (for OV200k) ¹⁾
Thermocouple cold junction compensation	Yes (excluding type B)
Additive error due compensation cold junction	<3% of range of internal thermometer
Internal thermometer	
Type	NTC12k / 25°C
Range	-20 ÷ +80°C
Measurement error	< 4%

¹⁾ The measurement error rises for resistors higher than 50kΩ.

Type of analog input has to be selected in the module configuration in programming environment and by setting of configuration jumpers on the module see following figures.

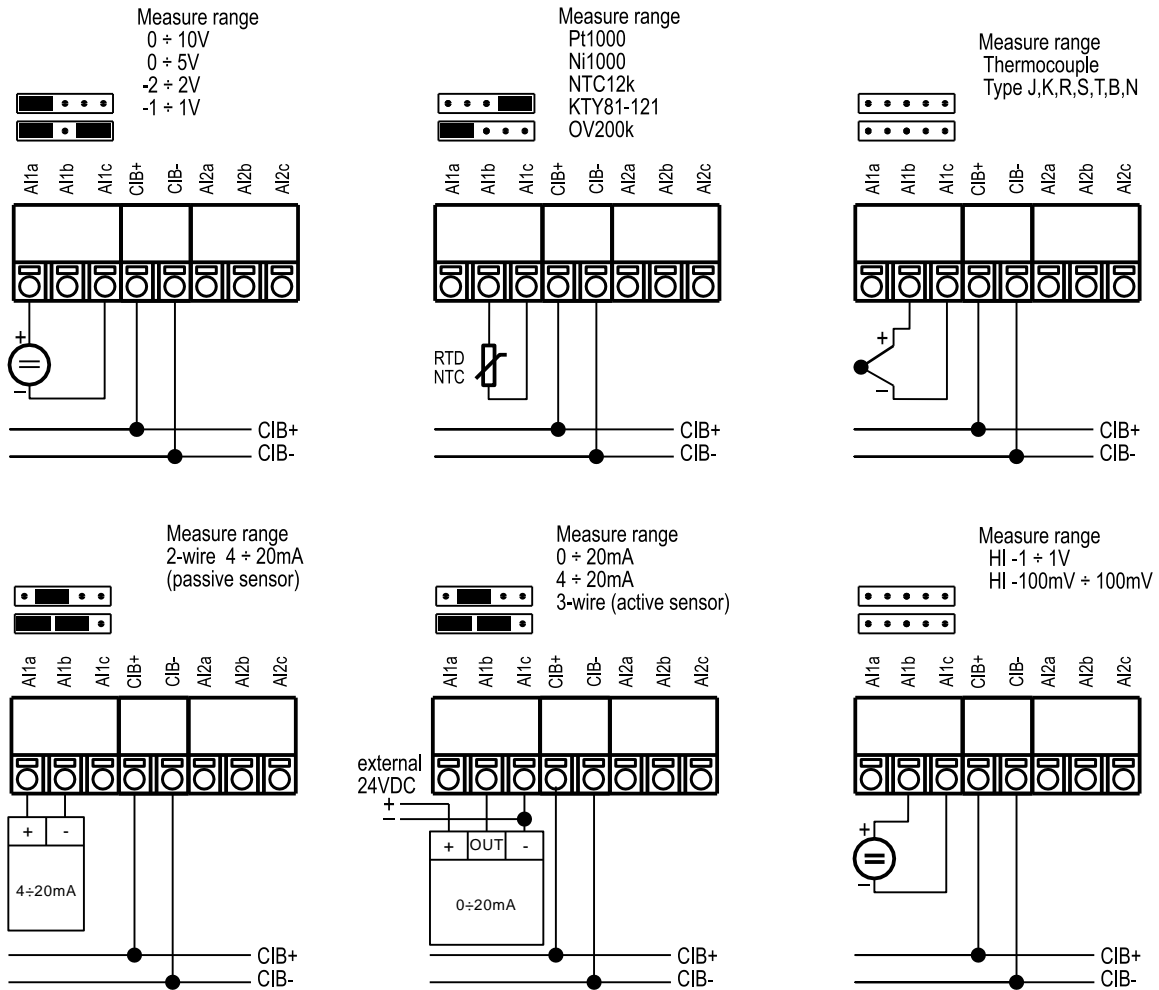

Fig. 3. 37 Connecting the sensors and setting of configuration jumpers

3.20.1. Configuration

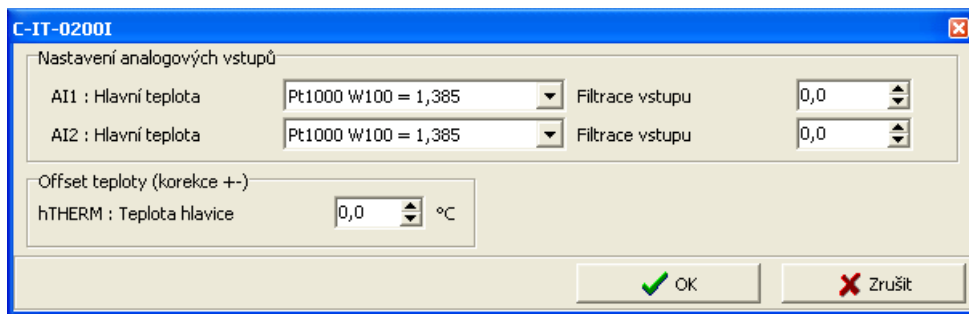

Fig. 3.38 Module configuration

Temperature offset

Correction offset of thermometer, which will be added on the measured temperature of internal thermometer. Internal thermometer is used for cold junction compensation of the thermocouples measurement. Offset affects the thermocouples measurement.

Setting analog inputs

Choosing the type of analog input:

- Pt1000, $W_{100} = 1,385$, -90/+320°C
- Pt1000, $W_{100} = 1,391$, -90/+320°C
- Ni1000, $W_{100} = 1,617$, -60/+200°C
- Ni1000, $W_{100} = 1,500$, -60/+200°C
- NTC 12k (negative thermistor, 12kΩ at 25°C), -40/+125°C
- KTY 81-121, -55/+125°C
- OV200k (0 ÷ 200kΩ)
- 0 ÷ 10V
- 0 ÷ 5V
- ±2V
- ±1V
- HI ±1V (Voltage range ±1V, High impedance inputs)
- HI ±100mV (Voltage range ±100mV, High impedance inputs)
- 0 ÷ 20mA
- 4 ÷ 20mA

Input filtering

By specifying a non-zero value of the time constant, the 1st order digital filter is activated. The filter is given by

$$y_t = \frac{y_{t-1} \cdot \tau + x}{\tau + 1}$$

- x - the current value of the analog input
- y_t - output
- y_{t-1} - recent output
- τ -time constant of the 1st order filter (TAU)

Value of time constant is set in the range 0.1 ÷ 25.4 and it represents a time constant in the range of 100 ms ÷ 25.4 s (value 255 is intended for service purposes).

3.20.2. The structure of the transmitted data

Module contains 4 devices total, each of them can be activated/deactivated:

- device 1, input, 1*STAT (status of analog inputs)
- device 2, input, 1*AI (input AI1)
- device 3, input, 1*AI (input AI2)
- device 4, input, 1*AI (internal thermometer)

The devices are incorporated into the structure of the transmitted data, which is evident from window *I/O setting* in the Mosaic. Window is accessible by pressing the icon  in toolbar.

3.20. C-IT-0200I

Struktura dat	Úplný zápis	Alias	Svorka	Abs./délka	Hodnota
MI_CIB1_IN : TMI_CIB1_ID1_IN	MI_CIB1_IN~ID1_IN				
STAT : TCIB_CIT0200I_STAT	MI_CIB1_IN~ID1_IN~STAT				\$00
OUF1 : BOOL	MI_CIB1_IN~ID1_IN~STAT~OUF1			%R4.0	0
VLD1 : BOOL	MI_CIB1_IN~ID1_IN~STAT~VLD1			%R4.1	0
OUF2 : BOOL	MI_CIB1_IN~ID1_IN~STAT~OUF2			%R4.2	0
VLD2 : BOOL	MI_CIB1_IN~ID1_IN~STAT~VLD2			%R4.3	0
hOUF : BOOL	MI_CIB1_IN~ID1_IN~STAT~eOUF			%R4.4	0
hVLD : BOOL	MI_CIB1_IN~ID1_IN~STAT~eVLD			%R4.5	0
AI1 : REAL	MI_CIB1_IN~ID1_IN~AI1			%RF5	0
AI2 : REAL	MI_CIB1_IN~ID1_IN~AI2			%RF9	0
hTHERM : REAL	MI_CIB1_IN~ID1_IN~hTHERM			%RF13	0

Fig. 3.39 The structure of the transmitted data

Input data

STAT	AI1	AI2	hTHERM
------	-----	-----	--------

STAT - status byte (8x type bool)

	-	-	hVLD	hOUF	VLD2	OUF2	VLD1	OUF1
Bit	.7	.6	.5	.4	.3	.2	.1	.0

OUF1 - overflow / underflow of range of analog input AI1

VLD1 - AI1 analog input reading validity

OUF2 - overflow / underflow of range of analog input AI2

VLD2 - AI2 analog input reading validity

hOUF - overflow/underflow of the range of internal auxiliary temperature sensor

hVLD - validity of the reading of internal auxiliary temperature sensor

AI1 - value of analog input AI1 (type real) [°C], [kΩ], [mV], [mA]

AI2 - value of analog input AI2 (type real) [°C], [kΩ], [mV], [mA]

The value of temperature sensors is converted and transferred in °C, for general resistor range of 200kΩ the value is converted and transferred in kΩ (with resolution of 10Ω). For voltage ranges the value is transferred in mV and for current ranges it is transferred in mA.

hTHERM - temperature of auxiliary internal sensor (type real) [°C]

3.21. C-IT-0200R

Module of temperature sensor is designed for measuring the temperature in the interior. It contains 2 temperature sensors. One sensor in the module is permanently connected and represents internal thermometer. The input for second sensor is led out on the terminal and the stand alone external temperature sensor can be connected..

After removing the plastic cover the RUN LED indicator and the terminals are accessible (for connection to the CIB bus and for an external temperature sensor).Connecting on the CIB bus (connection to the power supply) is indicated by permanent lit of the RUN LED. Module operation on the CIB is indicated by regular flashing of the RUN LED.

Module is designed for Time and Element designs of ABB production. For actual offer of designs see the catalogue of Teco

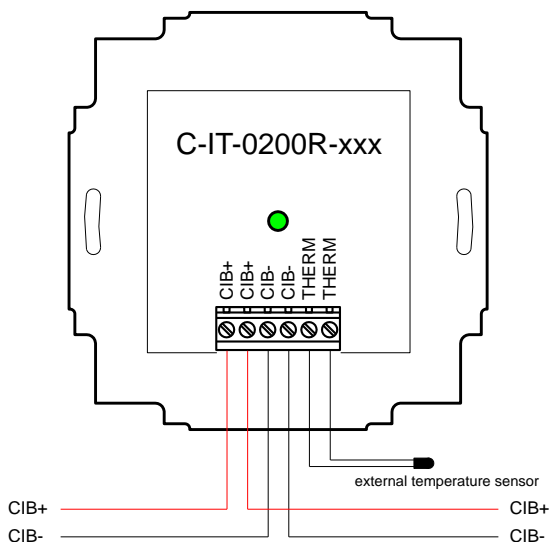

Fig. 3. 40 View and connection example C-IT-0200R

Tab. 3.21 Basic parameters C-IT-0200R

Temperature inputs	
Quantity	2
Sensor type	Thermistor NTC 12k
External sensor type	Thermistor NTC 12k
Range	-20 ÷ +80 °C
Resolution	0.1 °C
Accuracy	0.6 °C
Temperature settling time	60 min.
Power supply	
Power supply and communication	24 V (27 V) from the CIB
Nominal power consumption	15 mA
Galvanic isolation	No
Dimensions and weight	
Dimensions ¹⁾	89 × 87 × 18mm
Weight	80 g
Operating and installation conditions	
Operating temperature	0 ÷ +55 °C
Storage temperature	-25 ÷ +70 °C
IP degree of protection acc. IEC 529	IP 10B
Overvoltage category EN 60664	II
Degree of pollution EN 60664	1
Operating position	vertical
Installation	into the flush box
Connecting	screw type terminals
Cross-section of wires	max. 1,0 mm ²

65) Dimensions according the specifics of used design. The height 18 mm is only the height above the level of the plastic flush installation box. Height of the bottom part located in the flush installation box is 13 mm.

3.21.1. Configuration

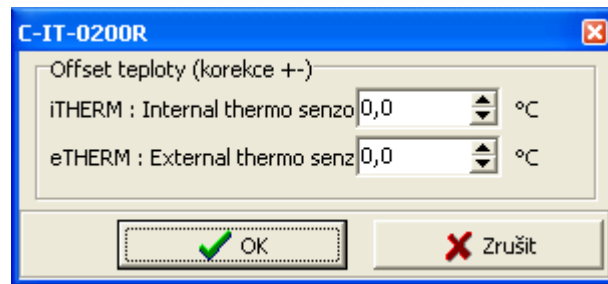

Fig. 3.41 Module configuration

Temperature offset

Correction offset of thermometer, which will be added on the measured temperature.

3.21.2. The structure of the transmitted data

Module contains 3 devices in total:

- device 1, input, 1*STAT (status)
- device 2, input, 1*AI (internal thermometer)
- device 3, input, 1*AI (external thermometer)

The devices are incorporated into the structure of the transmitted data, which is evident from window *I/O setting* in the Mosaic. Window is accessible by pressing the icon  in toolbar.

Struktura dat	Úplný zápis	Alias	Svorka	Abs./délka	Hodnota
Statistic_MI_CIB1 : TCHStatistic	r0_p2_Statistic_MI_CIB1			%X0 / 10	
Control_MI_CIB1 : TCHControl	r0_p2_Control_MI_CIB1			%Y0 / 2	\$0000
ID1_IN : TMI_CIB1_ID1_IN	MI_CIB1_IN~ID1_IN				
STAT : TCIB_CIT0200_STAT	MI_CIB1_IN~ID1_IN~STAT				\$00
iOUF : BOOL	MI_CIB1_IN~ID1_IN~STAT~iOUF			%R204.0	0
iVLD : BOOL	MI_CIB1_IN~ID1_IN~STAT~iVLD			%R204.1	0
eOUF : BOOL	MI_CIB1_IN~ID1_IN~STAT~eOUF			%R204.2	0
eVLD : BOOL	MI_CIB1_IN~ID1_IN~STAT~eVLD			%R204.3	0
iTHERM : REAL	MI_CIB1_IN~ID1_IN~iTHERM			%RF205	0
eTHERM : REAL	MI_CIB1_IN~ID1_IN~eTHERM			%RF209	0

Fig. 3.42 The structure of the transmitted data

Input data

STAT	iTHERM	eTHERM
------	--------	--------

CIB UNITS, MODULES

STAT - status byte (8x type bool)

	-	-	-	-	eVLD	eOUF	iVLD	iOUF
Bit	.7	.6	.5	.4	.3	.2	.1	.0

iOUF - overflow/underflow of the range of internal temperature sensor

iVLD - validity of the reading of internal temperature sensor

eOUFx - overflow/underflow of the range of external temperature sensor

eVLD - validity of the reading of external temperature sensor

iTHERM - temperature of internal sensor (type real) [°C]

eTHERM - temperature of external sensor (type real) [°C]

3.22. C-IT-0200S

Module contains 2 universal inputs. Each of the universal inputs can be used either as the binary input for potential free contacts or as a balanced input for alarm detectors (security systems) or as the analog input for connecting a resistance or temperature sensor.

The mechanical design of the module is designed to be mounted under cover of device (ingress protection of the module IP10B). Signals of the module are available on ribbon cable.

signalling green RUN LED is accessible from the side of module opposite to ribbon cable. Connecting on the CIB bus (connection to the power supply) is indicated by permanent lit of the RUN LED. Module operation on the CIB is indicated by regular flashing of the RUN LED.

For sensors Pt1000, Ni1000, KTY81-121, and sensor TC and TZ (thermistor NTC12k) module performs the conversion and linearization of measured values directly to temperature. For other types of resistors (in range 0 to 160 k Ω) the conversion to the temperature has to be done in user program in CPU (module gives the value in k Ω , with resolution 10 Ω).

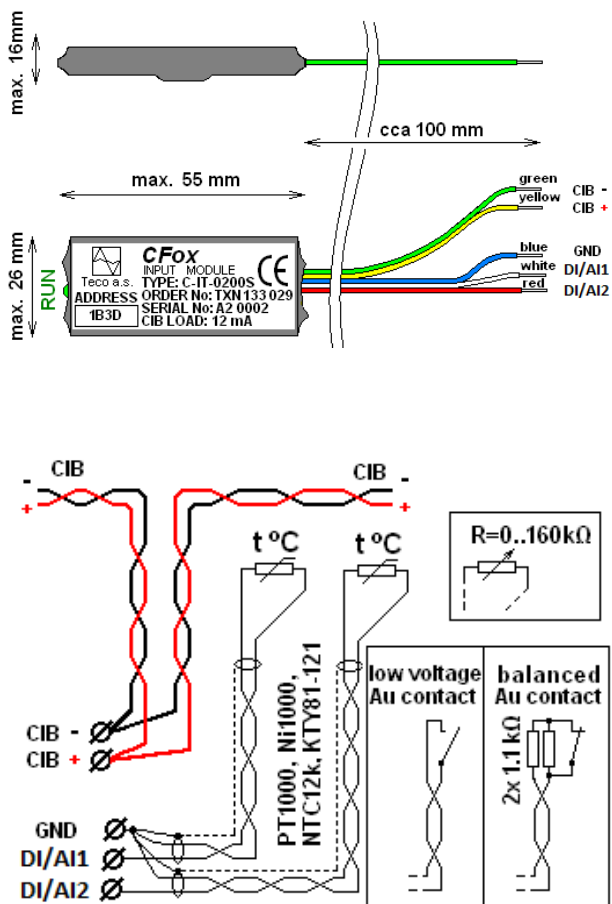

Fig. 3.43 View and connection C-IT-0200S

Tab. 3.22 Basic parameters C-IT-0200S

Universal inputs	
Quantity	2
Optional types of inputs	Binary, balanced, Pt1000, Ni1000, NTC12kΩ, KTY81-121, resistance 160kΩ
Binary input	NO contact (0/1) (Normally Open)
Balanced input for security detectors	Resistance 1x2k2, or 2x1k1
Pt1000	-90 ÷ +320 °C
Ni1000	-60 ÷ +200 °C
NTC 12kΩ	-40 ÷ +125 °C
KTY81-121	-55 ÷ +125 °C
Resistance input	0 ÷ 160kΩ
Resolution	0.1 °C / 10Ω
Accuracy	0,5 %
Period of refresh AI	typically 5s
Power supply	
Power supply and communication	24 V (27 V) from the CIB
Nominal power consumption	10 mA
Max. power consumption	12 mA
Galvanic isolation	No
Dimensions and weight	
Dimensions	max. 55 × 26 × 16mm
Weight	3 g
Operating and installation conditions	
Operating temperature	0 ÷ +55 °C
Storage temperature	-25 ÷ +70 °C
IP degree of protection acc. IEC 529	IP10B
Overvoltage category	II (according to EN 60664)
Degree of pollution	1 (according to EN 60664)
Operating position	Arbitrary
Installation	
Type	under cover of device
Connecting	Ribbon cable 0.15 mm ²

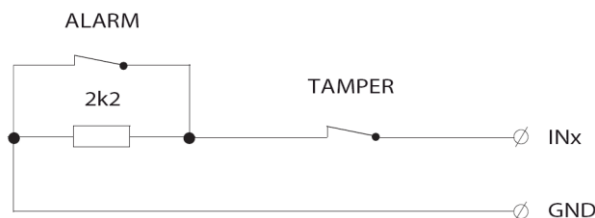

Fig. 3. 44 Simply balanced input for security detectors

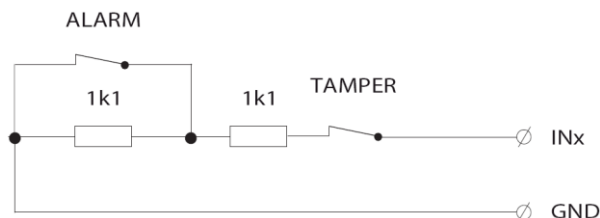

Fig. 3. 45 Double-balanced input for security detectors

3.22.1. Configuration

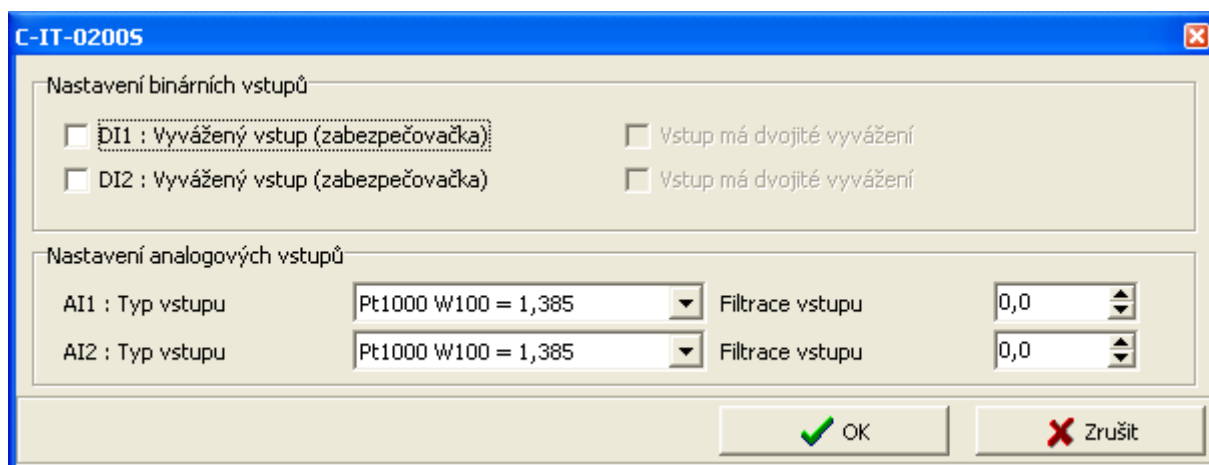

Fig. 3.46 Module configuration

The input terminals DI/AIx are **shared** for binary and analog inputs (for digital and analog equipment). As the input is configured as analog one, **it is not possible** use it as binary input **in the same time**. Depending on the configured input (as enabled devices) specific items of configuration dialog are enabled/disabled. Enabling devices see. chap.2.1 *Master configuration*, check the box *Show units, devices*

Balanced input

By checking the item, the respective input will be evaluated as a simple balanced binary alarm input. If the item is not checked, the respective input evaluated as a normal binary input (on/off).

Double balanced input

By checking the item, respective input will be evaluated as a double balanced binary alarm input. If the item is not checked and the input is configured for security systems (balanced input), the respective input evaluated as alarm input with a simple balance.

Type of input

Choosing the type of analog input:

Pt1000, $W_{100} = 1,385$, $-90/+320^{\circ}\text{C}$

Pt1000, $W_{100} = 1,391$, $-90/+320^{\circ}\text{C}$

Ni1000, $W_{100} = 1,617, -60/+200^{\circ}\text{C}$

Ni1000, $W_{100} = 1,500, -60/+200^{\circ}\text{C}$

NTC 12k (negative thermistor, $12\text{k}\Omega$ at 25°C), $-40/+125^{\circ}\text{C}$

KTY 81-121, $-55/+125^{\circ}\text{C}$

OV160k ($0 \div 160\text{k}\Omega$)

Input filtering

By specifying a non-zero value of the time constant, the 1st order digital filter is activated. The filter is given by

$$y_t = \frac{y_{t-1} \cdot \tau + x}{\tau + 1}$$

- x - the current value of the analog input
- y_t - output
- y_{t-1} - recent output
- τ -time constant of the 1st order filter (TAU)

Value of time constant is set in the range $0.1 \div 25.4$ and it represents a time constant in the range of $100 \text{ ms} \div 25.4 \text{ s}$ (value 255 is intended for service purposes).

3.22.2. The structure of the transmitted data

Module contains 4 devices in total:

- device 1, input, 2*DI/EZS
- device 2, input, 1*STAT (status AIx)
- device 3, input, 1*AI (input AI1)
- device 4, input, 1*AI (input AI2)

The devices are incorporated into the structure of the transmitted data, which is evident from window *I/O setting* in the Mosaic. Window is accessible by pressing the icon  in toolbar.

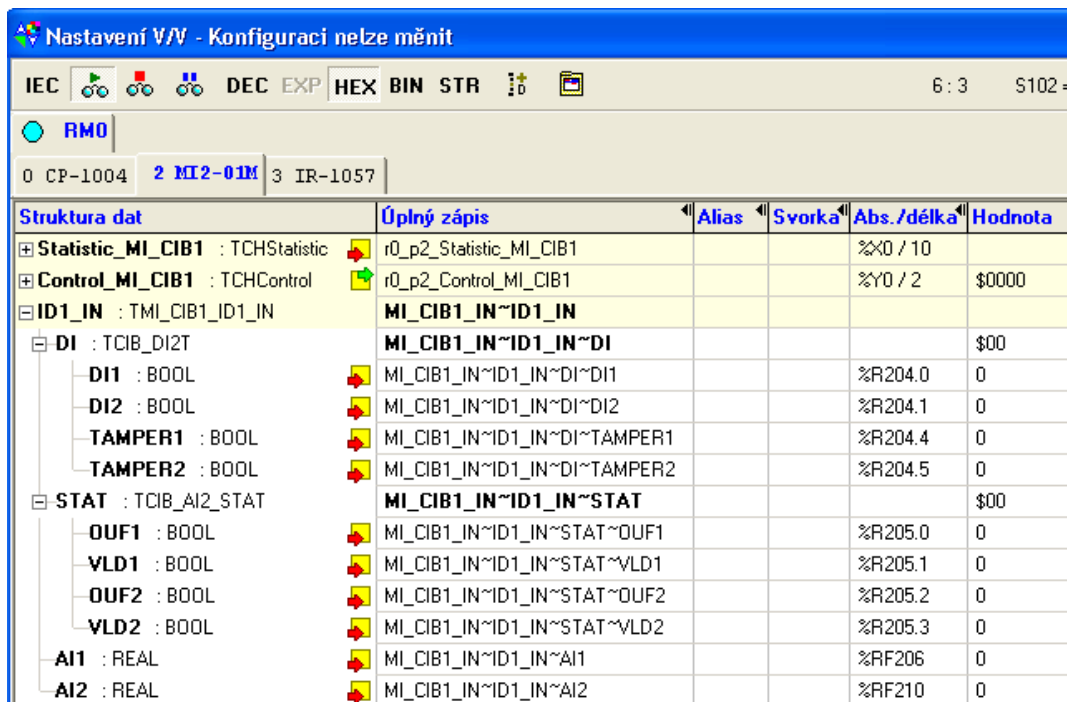

Fig. 3.47 The structure of the transmitted data

Input data

DI	STAT	AI1	AI2
----	------	-----	-----

DI - status of binary inputs, signalling "tamper" status of alarm inputs (8x type bool)

	-	-	TAMPER2	TAMPER1	-	-	DI2	DI1
Bit	.7	.6	.5	.4	.3	.2	.1	.0

DI1 - the current status of the binary DI1/balanced for alarm input1

DI2 - the current status of the binary DI2/balanced for alarm input 2

TAMPER1 - tamper status on balanced input 1

TAMPER2 - tamper status on balanced input 2

STAT - status byte of analog inputs (8x type bool)

	-	-	-	-	VLD2	OUF2	VLD1	OUF1
Bit	.7	.6	.5	.4	.3	.2	.1	.0

OUF1 - overflow / underflow of range of analog input AI1

VLD1 - AI1 analog input reading validity

OUF2 - overflow / underflow of range of analog input AI2

VLD2 - AI2 analog input reading validity

AI1 - value of analog input AI1 (type real) [°C],[kΩ]

AI2 - value of analog input AI2 (type real) [°C],[kΩ]

The value of temperature sensor is transferred in °C (with resolution of 0.1°C), the value of general resistance in range 160kΩ is transferred in kΩ (with resolution of 10Ω).

3.23. C-IT-0504S

Module contains 5 universal inputs and 4 analog outputs (0-10V). Each of the universal inputs can be used either as the binary input for potential free contacts or as a balanced input for alarm detectors (security systems) or as the analog input for connecting a resistance or temperature sensor. Inputs can be configured into two groups, 4+1.

The mechanical design of the module is designed to be mounted under cover of device (ingress protection of the module IP10B). Signals of the module are available on ribbon cable.

The green LED indicating the RUN mode is available from the side of the module next to the connector. Connecting on the CIB bus (connection to the power supply) is indicated by permanent lit of the RUN LED. Module operation on the CIB is indicated by regular flashing of the RUN LED.

For sensors Pt1000, Ni1000, KTY81-121, and sensor TC and TZ (thermistor NTC12k) module performs the conversion and linearization of measured values directly to temperature. For other types of resistors (in range 0 to 160 k Ω) the conversion to the temperature has to be done in user program in CPU (module gives the value in k Ω , with resolution 10 Ω).

3.23. C-IT-0504S

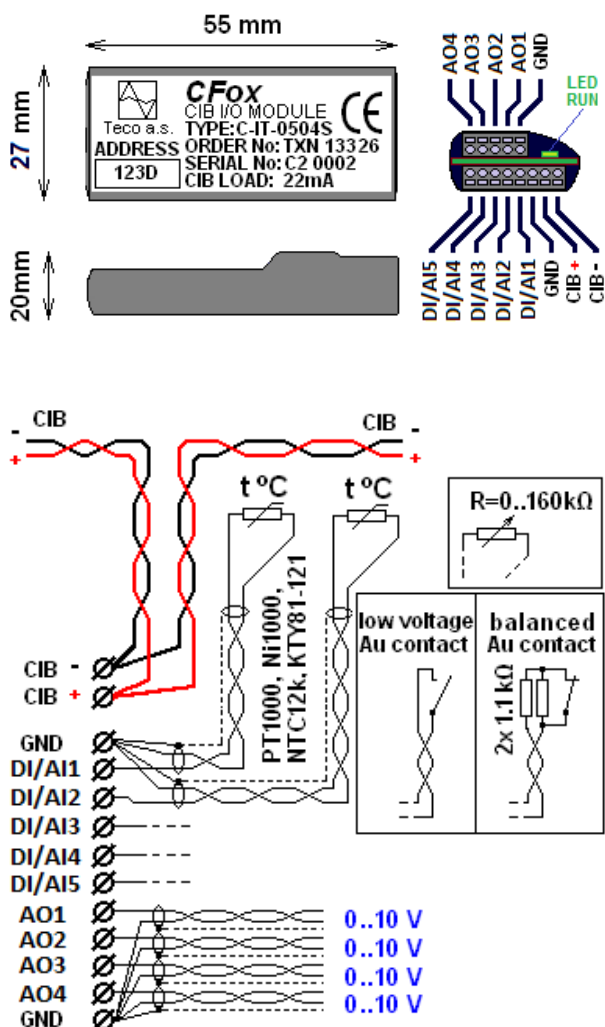

Fig. 3.48 View and connection C-IT-0504S

Tab. 3.23 Basic parameters C-IT-0504S

Universal inputs	
Quantity	5
Optional types of inputs	Binary, balanced, Pt1000, Ni1000, NTC12k Ω , KTY81-121, resistance 160k Ω
Binary input	NO contact (0/1) (Normally Open)
Balanced input for security detectors	Resistance 1x2k2, or 2x1k1
Pt1000	-90 \div +320 $^{\circ}$ C
Ni1000	-60 \div +200 $^{\circ}$ C
NTC 12k Ω	-40 \div +125 $^{\circ}$ C
KTY81-121	-55 \div +125 $^{\circ}$ C
Resistance input	0 \div 160k Ω
Resolution	0.1 $^{\circ}$ C / 10 Ω
Accuracy	0,5 %
Period of refresh AI	typically 5s
Analog outputs	
Quantity	4
Type, nominal voltage U_{im}	Voltage, 0 \div 10V
Load resistance	>1 k Ω
Adjustable range	0 \div 125% U_{im}
Minimal resolution	1%
Power supply	
Power supply and communication	24 V (27 V) from the CIB
Nominal power consumption	22 mA
Max. power consumption	80 mA
Galvanic isolation	No
Dimensions and weight	
Dimensions	max. 55 \times 26 \times 20mm
Weight	7 g
Operating and installation conditions	
Operating temperature	0 \div +70 $^{\circ}$ C
Storage temperature	-25 \div +85 $^{\circ}$ C
IP degree of protection acc. IEC 529	IP10B
Overvoltage category	II (according to EN 60664)
Degree of pollution	1 (according to EN 60664)
Operating position	Arbitrary
Type of operation	Continuous
Installation	
Type	under cover of device
Connection terminals	Spring-loaded, 0.15 \div 0.5 mm ²

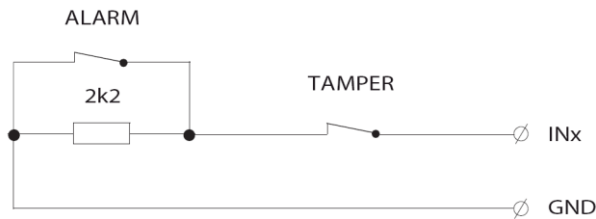

Fig. 3. 49 Simply balanced input for security detectors

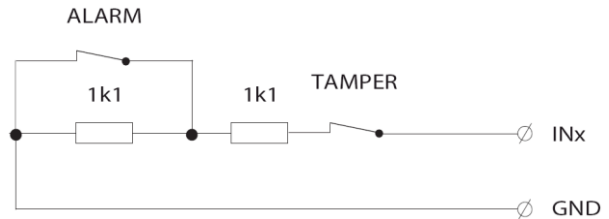

Fig. 3. 50 Double-balanced input for security detectors

3.23.1. Configuration

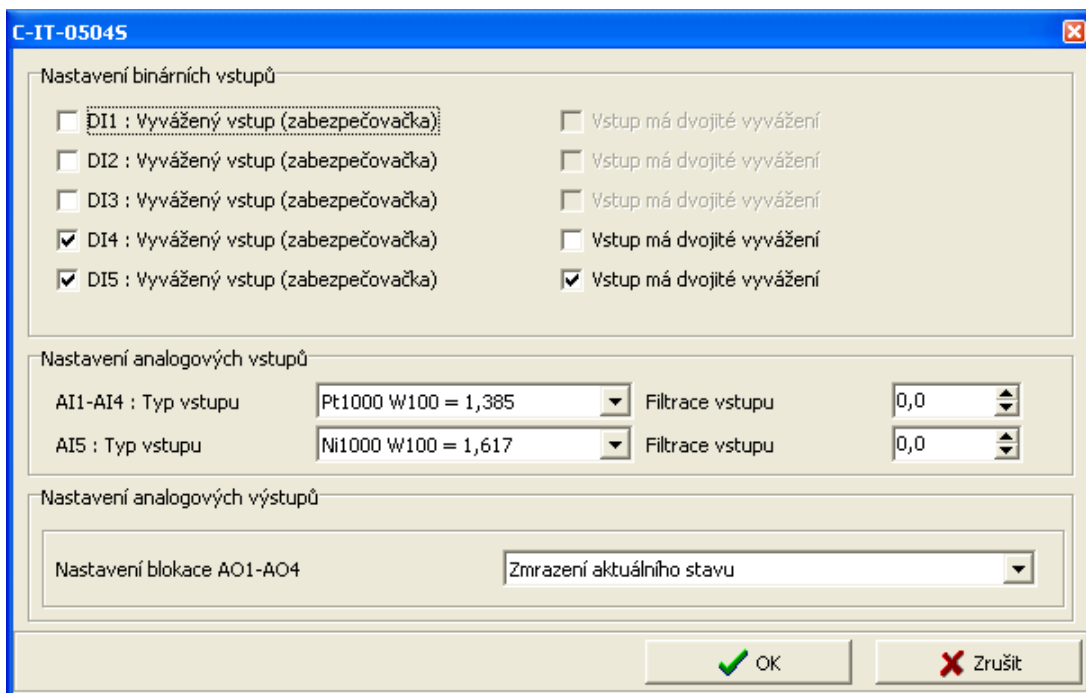

Fig. 3.51 Module configuration

The input terminals DI/AIx are **shared** for binary and analog inputs (for digital and analog equipment).As the input is configured as analog one, **it is not possible** use it as binary input **in the same time**. In terms of configuration, the analog inputs are divided into two groups, 4 +1. In the first group there are the inputs AI1-AI4, the second group there is stand alone input AI5. Depending on the configured type of input (as enabled device) the specific items are accessible / inaccessible in configuration dialog. Enabling devices see. chap.[2.1](#) *Master configuration*, check the box *Show units, devices*.

Balanced input

By checking the item, the respective input will be evaluated as a simple balanced binary alarm input. If the item is not checked, the respective input evaluated as a normal binary input (on/off).

Double balanced input

By checking the item, respective input will be evaluated as a double balanced binary alarm input. If the item is not checked and the input is configured for security systems (balanced input), the respective input evaluated as alarm input with a simple balance.

Type of input

Choosing the type of analog input:

Pt1000, $W_{100} = 1,385$, -90/+320°C

Pt1000, $W_{100} = 1,391$, -90/+320°C

Ni1000, $W_{100} = 1,617$, -60/+200°C

Ni1000, $W_{100} = 1,500$, -60/+200°C

NTC 12k (negative thermistor, 12kΩ at 25°C), -40/+125°C

KTY 81-121, -55/+125°C

OV160k (0 ÷ 160kΩ)

Input filtering

By specifying a non-zero value of the time constant, the 1st order digital filter is activated. The filter is given by

$$y_t = \frac{y_{t-1} \cdot \tau + x}{\tau + 1}$$

- x - the current value of the analog input
- y_t - output
- y_{t-1} - recent output
- τ -time constant of the 1st order filter (TAU)

Value of time constant is set in the range 0.1 ÷ 25.4 and it represents a time constant in the range of 100 ms ÷ 25.4 s (value 255 is intended for service purposes).

Blocking of AO

It can be set for analog output AO1 if they should stay in their last state or they should be disconnected during transition into HALT mode.

3.23.2. The structure of the transmitted data

Module contains 5 devices in total:

- device 1, input, 5*DI/EZS
- device 2, output, 4*AO
- device 3, input, 1*STAT (status AIx)
- device 4, input, 4*AI (input AI1, AI2, AI3, AI4)
- device 5, input, 1*AI (input AI5)

The devices are incorporated into the structure of the transmitted data, which is evident from window *I/O setting* in the Mosaic. Window is accessible by pressing the icon  in toolbar.

CIB UNITS, MODULES

Struktura dat	Úplný zápis	Alias	Svorka	Abs./délka
▣ ID1_IN : TMI_CIB1_ID1_IN	MI_CIB1_IN~ID1_IN			
▣ DI : TCIB_DI5T	MI_CIB1_IN~ID1_IN~DI			
DI1 : BOOL	MI_CIB1_IN~ID1_IN~DI~DI1			%R204.0
DI2 : BOOL	MI_CIB1_IN~ID1_IN~DI~DI2			%R204.1
DI3 : BOOL	MI_CIB1_IN~ID1_IN~DI~DI3			%R204.2
DI4 : BOOL	MI_CIB1_IN~ID1_IN~DI~DI4			%R204.3
DI5 : BOOL	MI_CIB1_IN~ID1_IN~DI~DI5			%R204.4
TAMPER1 : BOOL	MI_CIB1_IN~ID1_IN~DI~TAMPER1			%R205.0
TAMPER2 : BOOL	MI_CIB1_IN~ID1_IN~DI~TAMPER2			%R205.1
TAMPER3 : BOOL	MI_CIB1_IN~ID1_IN~DI~TAMPER3			%R205.2
TAMPER4 : BOOL	MI_CIB1_IN~ID1_IN~DI~TAMPER4			%R205.3
TAMPER5 : BOOL	MI_CIB1_IN~ID1_IN~DI~TAMPER5			%R205.4
▣ STAT : TCIB_AI5_STAT	MI_CIB1_IN~ID1_IN~STAT			%R206 / 1
▣ AI : TCIB_AI4	MI_CIB1_IN~ID1_IN~AI			
AI1 : REAL	MI_CIB1_IN~ID1_IN~AI~AI1			%RF208
AI2 : REAL	MI_CIB1_IN~ID1_IN~AI~AI2			%RF212
AI3 : REAL	MI_CIB1_IN~ID1_IN~AI~AI3			%RF216
AI4 : REAL	MI_CIB1_IN~ID1_IN~AI~AI4			%RF220
AI5 : REAL	MI_CIB1_IN~ID1_IN~AI~AI5			%RF224
▣ ID1_OUT : TMI_CIB1_ID1_OUT	MI_CIB1_OUT~ID1_OUT			
▣ AO : TCIB_AO4	MI_CIB1_OUT~ID1_OUT~AO			
AO1 : REAL	MI_CIB1_OUT~ID1_OUT~AO~AO1			%RF228
AO2 : REAL	MI_CIB1_OUT~ID1_OUT~AO~AO2			%RF232
AO3 : REAL	MI_CIB1_OUT~ID1_OUT~AO~AO3			%RF236
AO4 : REAL	MI_CIB1_OUT~ID1_OUT~AO~AO4			%RF240

Fig. 3.52 The structure of the transmitted data

Input data

DI	STAT	AIx
----	------	-----

DI - status of binary inputs, signalling "tamper" status of alarm inputs (16x type bool)

-	-	-	DI5	DI4	DI3	DI2	DI1
Bit .7	.6	.5	.4	.3	.2	.1	.0

-	-	-	TAMPER5	TAMPER4	TAMPER3	TAMPER2	TAMPER1
Bit .15	.14	.13	.12	.11	.10	.9	.8

DIx - Current status of binary input DIx / alarm input x
 TAMPERx - tamper status on balanced input x

STAT - status byte of analog inputs (16x type bool)

VLD4	OUF4	VLD3	OUF3	VLD2	OUF2	VLD1	OUF1
Bit .7	.6	.5	.4	.3	.2	.1	.0

-	-	-	-	-	-	VLD5	OUF5
Bit .15	.14	.13	.12	.11	.10	.9	.8

OUFx - overflow / underflow of range of analog input AIx
 VLDx - validity of reading of analog input AIx

A/x - value of analog input A/x (5x type real) [°C],[kΩ]

The value of temperature sensor is transferred in °C (with resolution of 0.1°C), the value of general resistance in range 160kΩ is transferred in kΩ (with resolution of 10Ω).

Output data

AOx

- value of analog output (4x type real) [0-100%]

3.23.3. Module specifics

For the proper operation of this module in the CIB network the firmware version in the parent module CIB master MI2-01M / MI2-02M is required to be at least v1.6 or higher!!!

3.24. C-IT-0908S

Module contains 6 binary inputs, 2 universal inputs, 1 analog input and 8 binary outputs. The module is designed primarily for CIB coupling of wall switches with the dry contacts and LED indicators (e.g. switches from Jung, Gira, ...).

Each of the universal inputs can be used either as the binary input for potential free contacts or as a balanced input for alarm detectors (security systems) or as the analog input for connecting a resistance or temperature sensor. Analog input is designed for connecting of resistive temperature sensors. Binary inputs are designed only for connecting the LED indicators (with common cathode).

The mechanical design of the module is designed to be mounted under cover of device (ingress protection of the module IP10B). Signals of module are led out by removable connectors with separated wires.

The green LED indicating the RUN mode is available from the side of the module opposite to the connectors. Connecting on the CIB bus (connection to the power supply) is indicated by permanent lit of the RUN LED. Module operation on the CIB is indicated by regular flashing of the RUN LED.

For sensors Pt1000, Ni1000, KTY81-121, and sensor TC and TZ (thermistor NTC12k) module performs the conversion and linearization of measured values directly to temperature. For other types of resistors (in range 0 to 160 kΩ) the conversion to the temperature has to be done in user program in CPU (module gives the value in kΩ, with resolution 10 Ω).

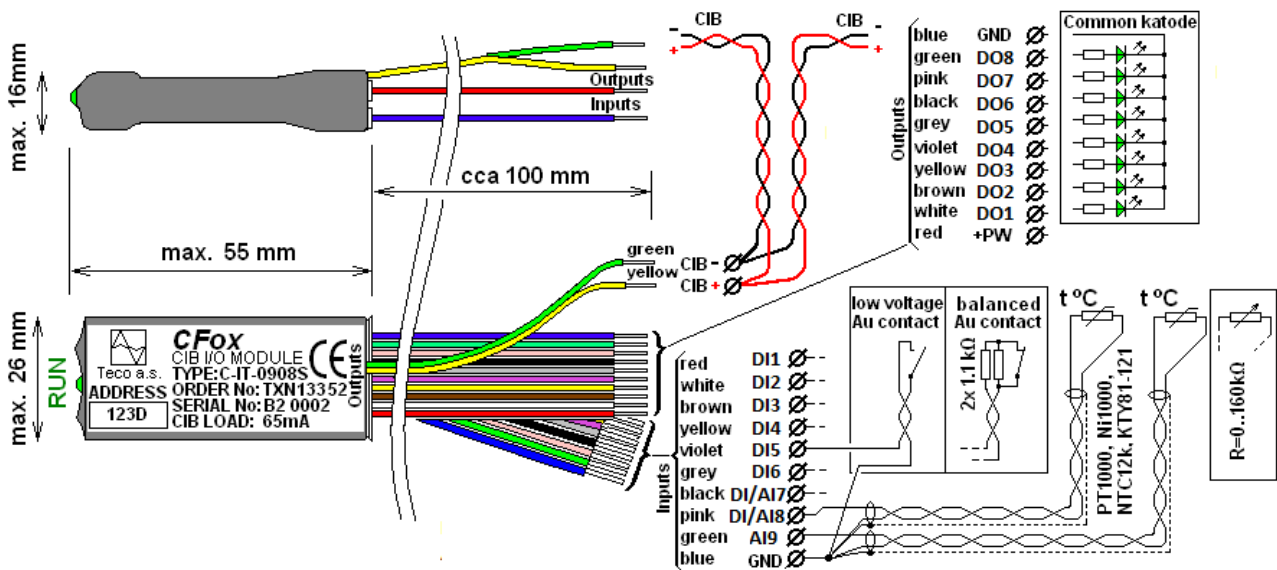

Fig. 3. 53 View and connection C-IT-0908S

Tab. 3.24 Basic parameters C-IT-0908S

Binary inputs	
Quantity	6
Optional types of inputs	Normally open contact NO (0..>1,5kΩ / 1..<0,5kΩ), or balanced input (1x2k2, 2x1k1)
Galvanic isolation	No
Binary outputs	
Quantity, type	8, to drive LED indicators
Max. output current	3 mA
Open collector PNP max. voltage	27V
Galvanic isolation	No

Universal inputs, Analog inputs	
Quantity of universal inputs	2
Optional types of universal inputs	Binary, balanced, Pt1000, Ni1000, NTC12kΩ, KTY81-121, resistance 160kΩ
Quantity of analog inputs.	1
Optional types of analog inputs	Binary, Pt1000, Ni1000, NTC12kΩ, KTY81-121, resistance 160kΩ
Resolution	0.1 °C / 10Ω
Accuracy	0,5 %
Period of refresh AI	typically 5s
Galvanic isolation	No

Power supply	
Power supply and communication	24 V (27 V) from the CIB
Nominal power consumption	30 mA
Max. power consumption	65 mA
Operating and installation conditions	
Operating temperature	0 ÷ +70 °C
Storage temperature	-25 ÷ +85 °C
IP degree of protection acc. IEC 529	IP10B
Overvoltage category	II (according to EN 60664)
Degree of pollution	1 (according to EN 60664)
Operating position	Arbitrary
Type of operation	Continuous

Universal inputs, Analog inputs	
Binary input	Normally open contact NO (0..>1,5kΩ / 1..<0,5kΩ),
Balanced input for security detectors	Resistance 1x2k2, or 2x1k1
Pt1000	-90 ÷ +320 °C
Ni1000	-60 ÷ +200 °C
NTC 12kΩ	-40 ÷ +125 °C
KTY81-121	-55 ÷ +125 °C
Resistance input	0 ÷ 160kΩ
Dimensions and weight	
Dimensions	max. 55 × 26 × 16mm
Weight	7 g
Installation	
Type	under cover of device
Connecting	Ribbon cable 0.15mm ² (CIB) removable connectors with separated wires 0.14 mm ² /10cm

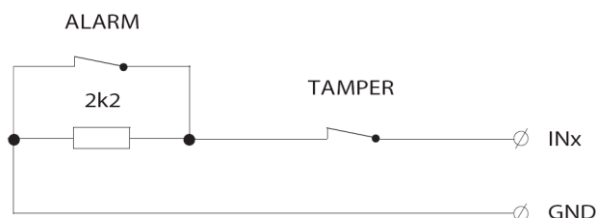

Fig. 3. 54 Simply balanced input for security detectors

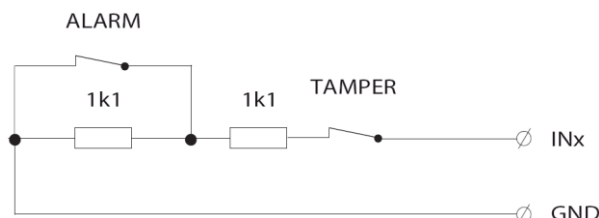

Fig. 3. 55 Double-balanced input for security detectors

3.24.1. Configuration

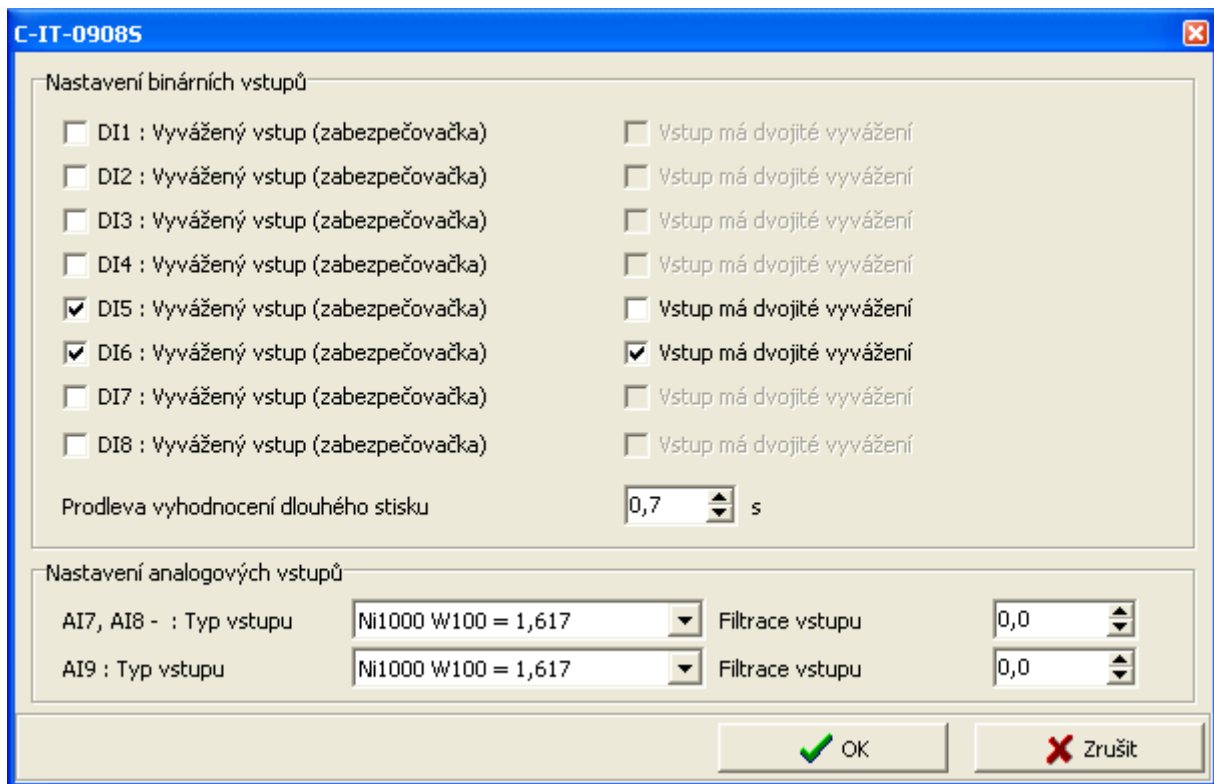

Fig. 3.56 Module configuration

The input terminals DI/AI7 and DI/AI8 are **shared** for both binary and analog inputs (for digital and analog equipment). As the input is configured as analog one, **it is not possible** use it as binary input **in the same time**. In terms of configuration, the analog inputs are divided into two groups, 2 +1. In the first group there are the inputs AI7-AI8, the second group there is stand alone input AI9. Depending on the configured type of input (as enabled device) the specific items are accessible / inaccessible in configuration dialog. Enabling devices see. chap.[2.1](#) *Master configuration*, check the box *Show units, devices*.

Balanced input

By checking the item, the respective input will be evaluated as a simple balanced binary alarm input. If the item is not checked, the respective input evaluated as a normal binary input (on/off).

Double balanced input

By checking the item, respective input will be evaluated as a double balanced binary alarm input. If the item is not checked and the input is configured for security systems (balanced input), the respective input evaluated as alarm input with a simple balance.

Delay, evaluation of long press

For binary (momentary button) inputs module directly evaluate the short and long presses on each input. By entering values one can set a delay time after which the activation of digital input DI is signalled as the long press (PRESS). Activating the digital input for period shorter than the

entered value will be signalled as the short press (CLICK). Delay period (T_{press}) can be inserted in the range $0.1 \div 2.5s$.

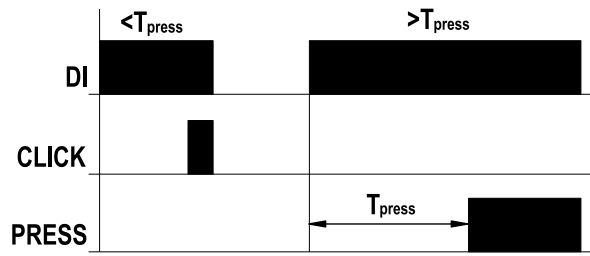

Fig. 3. 57 Evaluation of short / long press

Type of input

Choosing the type of analog input:

- Pt1000, $W_{100} = 1,385$, $-90/+320^{\circ}C$
- Pt1000, $W_{100} = 1,391$, $-90/+320^{\circ}C$
- Ni1000, $W_{100} = 1,617$, $-60/+200^{\circ}C$
- Ni1000, $W_{100} = 1,500$, $-60/+200^{\circ}C$
- NTC 12k (negative thermistor, $12k\Omega$ at $25^{\circ}C$), $-40/+125^{\circ}C$
- KTY 81-121, $-55/+125^{\circ}C$
- OV160k ($0 \div 160k\Omega$)

Input filtering

By specifying a non-zero value of the time constant, the 1st order digital filter is activated. The filter is given by

$$y_t = \frac{y_{t-1} \cdot \tau + x}{\tau + 1}$$

- x - the current value of the analog input
- y_t - output
- y_{t-1} - recent output
- τ - time constant of the 1st order filter (TAU)

Value of time constant is set in the range $0.1 \div 25.4$ and it represents a time constant in the range of $100 \text{ ms} \div 25.4 \text{ s}$ (value 255 is intended for service purposes).

3.24.1. The structure of the transmitted data

Module contains 5 devices in total:

- device 1, input, 8*DI/EZS
- device 2, output, 8*DO
- device 3, input, 1*STAT (status AIx)
- device 4, input, 2*AI (input AI7, AI8)
- device 5, input, 1*AI (input AI9)

CIB UNITS, MODULES

The devices are incorporated into the structure of the transmitted data, which is evident from window *I/O setting* in the Mosaic. Window is accessible by pressing the icon  in toolbar.

Struktura dat	Úplný zápis	Alias	Svorka	Abs./délka	Hodnota
[-] ID1_IN : TMI_CIB1_ID1_IN	MI_CIB1_IN~ID1_IN				
[-] DI : TCIB_CIT09_DI	MI_CIB1_IN~ID1_IN~DI			%R4 / 4	
[-] STAT : TCIB_CIT09_STAT	MI_CIB1_IN~ID1_IN~STAT				\$00
[-] OUF7 : BOOL	MI_CIB1_IN~ID1_IN~STAT~OUF7			%R8.0	0
[-] VLD7 : BOOL	MI_CIB1_IN~ID1_IN~STAT~VLD7			%R8.1	0
[-] OUF8 : BOOL	MI_CIB1_IN~ID1_IN~STAT~OUF8			%R8.2	0
[-] VLD8 : BOOL	MI_CIB1_IN~ID1_IN~STAT~VLD8			%R8.3	0
[-] OUF9 : BOOL	MI_CIB1_IN~ID1_IN~STAT~OUF9			%R8.4	0
[-] VLD9 : BOOL	MI_CIB1_IN~ID1_IN~STAT~VLD9			%R8.5	0
[-] AI : TCIB_CIT09_AI	MI_CIB1_IN~ID1_IN~AI				
[-] AI7 : REAL	MI_CIB1_IN~ID1_IN~AI~AI7			%RF9	0
[-] AI8 : REAL	MI_CIB1_IN~ID1_IN~AI~AI8			%RF13	0
[-] AI9 : REAL	MI_CIB1_IN~ID1_IN~AI~AI9			%RF17	0
[-] ID1_OUT : TMI_CIB1_ID1_OUT	MI_CIB1_OUT~ID1_OUT				\$00
[-] DOs : TCIB_DO8	MI_CIB1_OUT~ID1_OUT~DOs				\$00
[-] DO1 : BOOL	MI_CIB1_OUT~ID1_OUT~DOs~DO1			%R21.0	0
[-] DO2 : BOOL	MI_CIB1_OUT~ID1_OUT~DOs~DO2			%R21.1	0
[-] DO3 : BOOL	MI_CIB1_OUT~ID1_OUT~DOs~DO3			%R21.2	0
[-] DO4 : BOOL	MI_CIB1_OUT~ID1_OUT~DOs~DO4			%R21.3	0
[-] DO5 : BOOL	MI_CIB1_OUT~ID1_OUT~DOs~DO5			%R21.4	0
[-] DO6 : BOOL	MI_CIB1_OUT~ID1_OUT~DOs~DO6			%R21.5	0
[-] DO7 : BOOL	MI_CIB1_OUT~ID1_OUT~DOs~DO7			%R21.6	0
[-] DO8 : BOOL	MI_CIB1_OUT~ID1_OUT~DOs~DO8			%R21.7	0

Fig. 3.58 The structure of the transmitted data

Input data

DI	STAT	AI	AI9
----	------	----	-----

DI - status of binary inputs, short pulses, long pulses, tamper (32x type bool)

- DIx - Current status of binary input DIx / alarm input x
- CLICKx - short pulse (to log. 1) on input DIx
- PRESSx - long pulse (into log. 1) on input DIx
- TAMPERx - „tamper“ status of alarm input x

STAT - status byte of analog inputs (8x type bool)

	-	-	VLD9	OUF9	VLD8	OUF8	VLD7	OUF7
Bit	.7	.6	.5	.4	.3	.2	.1	.0

- OUFx - overflow / underflow of range of analog input AIx
- VLDx - validity of reading of analog input AIx

AI - value of analog inputs (2x type real) [°C],[kΩ]

- AI7 - value of analog input AI7
- AI8 - value of analog input AI8

3.24. C-IT-0908S

AI9 - value of analog input AI9 (1x type real) [°C],[kΩ]

The value of temperature sensor is transferred in °C (with resolution of 0.1°C), the value of general resistance in range 160kΩ is transferred in kΩ (with resolution of 10Ω).

Output data

DOs

DOs - status of binary LED outputs (8x type bool)

	DO8	DO7	DO6	DO5	DO4	DO3	DO2	DO1
Bit	.7	.6	.5	.4	.3	.2	.1	.0

DOx - value of binary LED output DOx

3.24.2. Module specifics

For the proper operation of this module in the CIB network the firmware version in the parent module CIB master MI2-01M / MI2-02M is required to be at least v1.6 or higher!!!

3.25. C-OR-0008M

Module contains 8 relay outputs. Each output has the changeover contacts. Each output can be locally manually controlled by buttons on the module. Mechanical design corresponds to the modular design with width of 6M for mounting on the DIN-rail.

Due to the higher power consumption module has two power options. Either it is powered directly from the CIB line, or is supplied from an external source. In case of power supply module directly from the CIB line is necessary **to keep the total maximum load CIB** if the connection load is exceeded, the modules must be C-OR-0008 supplied from external sources (there is a strain CIB lines(see chapter 2.3 Power CIB bus). If the load of the CIB line is exceeded , the modules C-OR-0008 must be supplied from external sources (to relieve CIB load).

After connecting the module to the CIB line (power connected) the green RUN LED lights still. If the module is served by the CIB (it communicates), green RUN LED flashes regularly.

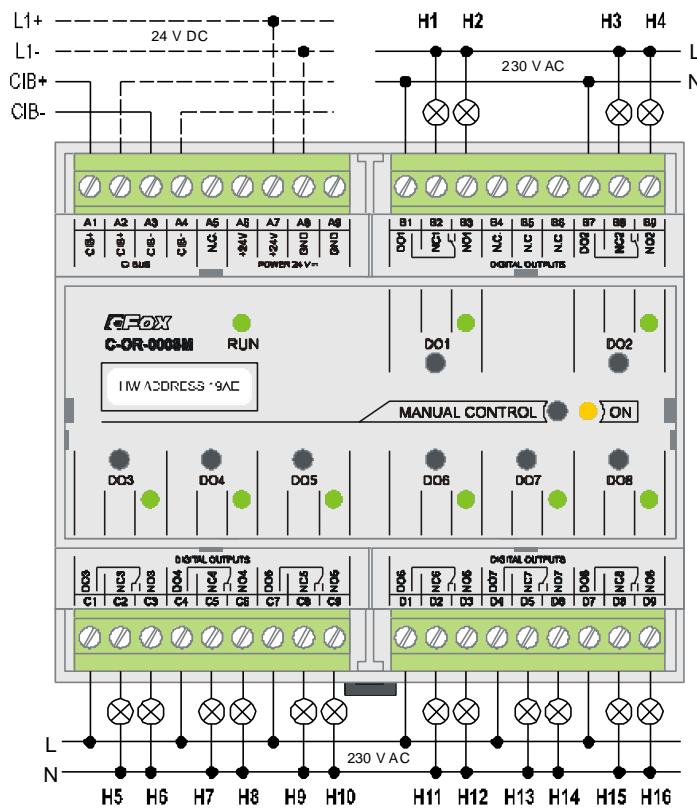

Fig. 3. 59 View and connection C-OR-0008M

Tab. 3.25 Basic parameters C-OR-0008M

Binary relay outputs	
Quantity	8
Outputs in group	1
Type of contacts	Changeover (NO / NC)
Switched voltage	Max. 300V AC / DC Min. 5V
Switched current	Min. 100 mA Max. 16 A pro NO Max. 10 A pro NC
Closing time	15 ms
Opening time	5 ms

Binary relay outputs	
Galvanic isolation	Yes
Insulation voltage	
- between outputs and internal circuits	4000 V AC
- between contacts	1000 V AC
Mechanical lifetime	Min. 20 000 000 cycles
Electrical lifetime	Min. 50 000 cycles

3.25. C-OR-0008M

Protection against short circuit	No
Protection against inductive load	External (RC circuit, diode, varistor)

Power supply	
Power supply and communication	24 V (27 V) from the CIB
External power	24 V DC
Max. power consumption	160 mA
Dimensions and weight	
Dimensions	90 × 58 × 105mm
Weight	310g

Operating and installation conditions	
Operating temperature	-10 ÷ +55 °C
Storage temperature	-25 ÷ +70 °C
IP degree of protection acc. IEC 529	IP10B
Operating position	Vertical
Type of operation	Continuous
Installation	on DIN rail
Connection terminals	Screw-type
Cross-section of wires	Max. 4 mm ²

3.25.1. Configuration

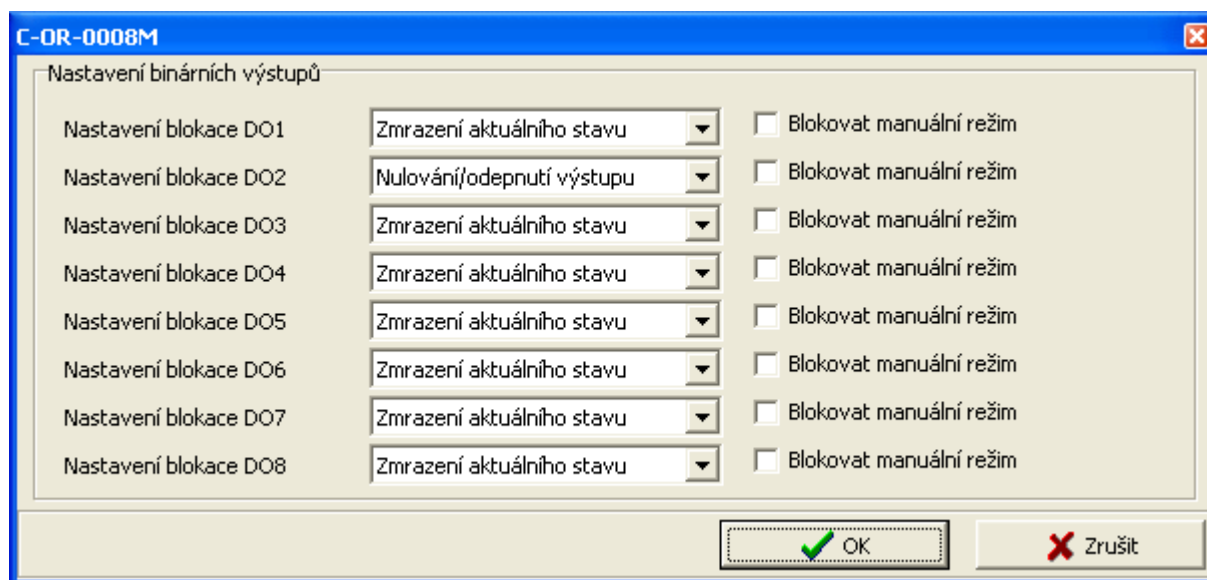

Fig. 3.60 Module configuration

Blocking of DO

It can be set for binary outputs and for analog output AO1 if they should stay in their last state or they should be disconnected during transition into HALT mode.

Blocking of manual mode

Checking the box the ability to manually control specific relay outputs in RUN mode is blocked. In the HALT mode the manual control of relay outputs is always allowed.

In RUN mode, the manual control is activated by pressing the button *MANUAL CONTROL* on module. At the same time the yellow indicator LED lights up *ON*. Then it is possible to change the status of each output by respective buttons. Another pressing the button *MANUAL CONTROL* LED indicator *ON* goes off and the manual mode is cancelled. Then LED outputs are controlled according to the commands of the CIB line. Activity of manual mode is also indicated in the module status variable *STAT.ManMode*.

3.25.1. The structure of the transmitted data

Module contains 2 devices in total:

- device 1, input, 1*STAT (status)
- device 2, output, 8*DO

The devices are incorporated into the structure of the transmitted data, which is evident from window *I/O setting* in the Mosaic. Window is accessible by pressing the icon  in toolbar.

Struktura dat	Úplný zápis	Alias	Svorka	Abs./délka	Hodnota
Statistic_MIO_CIB1 : TCHStatus	r3_p0_Statistic_MIO_CIB1			%X10 / 10	
Control_MIO_CIB1 : TCHControl	r3_p0_Control_MIO_CIB1			%Y7 / 2	\$0000
ID1_IN : TMIO_CIB1_ID1_IN	MIO_CIB1_IN~ID1_IN				\$00
STAT : TCIB_COR_STAT	MIO_CIB1_IN~ID1_IN~STAT				\$00
ManMode : BOOL	MIO_CIB1_IN~ID1_IN~STAT~ManMode			%R212.6	0
PowerErr : BOOL	MIO_CIB1_IN~ID1_IN~STAT~PowerErr			%R212.7	0
ID1_OUT : TMIO_CIB1_ID1_OUT	MIO_CIB1_OUT~ID1_OUT				\$00
DOs : TCIB_DO8	MIO_CIB1_OUT~ID1_OUT~DOs				\$00
DO1 : BOOL	MIO_CIB1_OUT~ID1_OUT~DOs~DO1			%R213.0	0
DO2 : BOOL	MIO_CIB1_OUT~ID1_OUT~DOs~DO2			%R213.1	0
DO3 : BOOL	MIO_CIB1_OUT~ID1_OUT~DOs~DO3			%R213.2	0
DO4 : BOOL	MIO_CIB1_OUT~ID1_OUT~DOs~DO4			%R213.3	0
DO5 : BOOL	MIO_CIB1_OUT~ID1_OUT~DOs~DO5			%R213.4	0
DO6 : BOOL	MIO_CIB1_OUT~ID1_OUT~DOs~DO6			%R213.5	0
DO7 : BOOL	MIO_CIB1_OUT~ID1_OUT~DOs~DO7			%R213.6	0
DO8 : BOOL	MIO_CIB1_OUT~ID1_OUT~DOs~DO8			%R213.7	0

Fig. 3.61 *The structure of the transmitted data*

Input data

STAT

STAT - status byte of module (8x type bool)

	PowerErr	ManMode	-	-	-	-	-	-
Bit	.7	.6	.5	.4	.3	.2	.1	.0

ManMode - signalling of manual control mode of binary outputs.

PowerErr - supply voltage drop below the limit for guaranteed switching of relay outputs DO

Output data

DOs

DOs - value of binary outputs (8x type bool)

	DO8	DO7	DO6	DO5	DO4	DO3	DO2	DO1
Bit	.7	.6	.5	.4	.3	.2	.1	.0

DOx - value of binary output DOx

3.26. C-OR-0202B

The module contains 2 relay outputs with changeover contact and 2 analog/digital inputs. Inputs allow connection of temperature sensor or potential-free switching contacts. The module is mechanically designed in the "box" for mounting into a flush installation box.

After connecting the module to the CIB line (power connected) the green RUN LED lights still. If the module is served by the CIB (it communicates), green RUN LED flashes regularly. LED indicators DOx indicate the status of binary outputs.

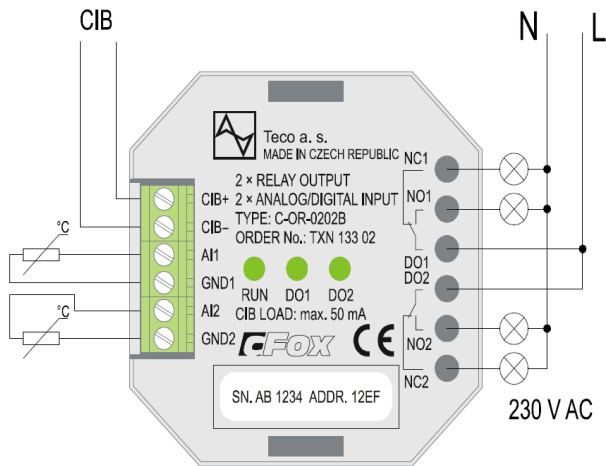

Fig. 3. 62 view C-OR-0202B

Power supply	
Power supply and communication	24 V (27 V) from the CIB
Max. power consumption	50mA
Galvanic isolation	No
Dimensions and weight	
Dimensions	50 × 50 × 30mm
Weight	70 g
Operating and installation conditions	
Operating temperature	-10 ÷ +55 °C
Storage temperature	-25 ÷ +70 °C
IP degree of protection acc. IEC 529	IP20B
Operating position	Arbitrary
Type of operation	Continuous

Tab. 3.26 Basic parameters C-OR-0202B

Universal inputs AI/DI	
Quantity	2
Optional types of inputs	Binary, balanced, Pt1000, Ni1000, NTC12kΩ, KTY81-121, resistance 160kΩ
Binary input	NO - normally open dry contact
Balanced input for security detectors	Resistance 1x2k2, or 2x1k1
Pt1000	-90 ÷ +320 °C
Ni1000	-60 ÷ +200 °C
NTC 12kΩ	-40 ÷ +125 °C
KTY81-121	-55 ÷ +125 °C
Resistance input	0 ÷ 160kΩ
Resolution	0.1 °C / 10Ω
Accuracy ¹⁾	0,5 %
Period of refresh AI	typically 5s
Galvanic isolation of CIB	No
Binary outputs DO	
Quantity	2
Number of outputs in group	1
Type of operation	relay, changeover contacts
Switched voltage	max. 300V AC/DC min. 5V
Switched current	max. 16A for NO max. 10A for NO min. 100mA
Installation	
Type	into the flush box
Connecting CIB and AI/DI	Screw type terminal
Cross-section of wires	max. 1.5 mm ²
Connecting the power cables	6x cable CY
Cross-section of wires	2.5 mm ² , length 90mm

¹⁾ The measurement error rises for resistors higher than 50kΩ.

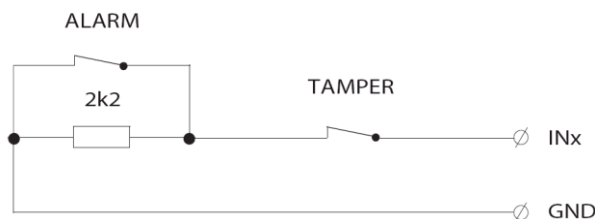

Fig. 3. 63 Simply balanced input for security detectors

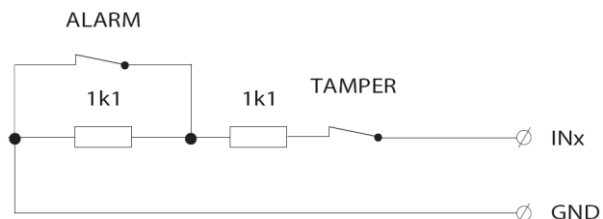

Fig. 3. 64 Double-balanced input for security detectors

3.26.1. Configuration

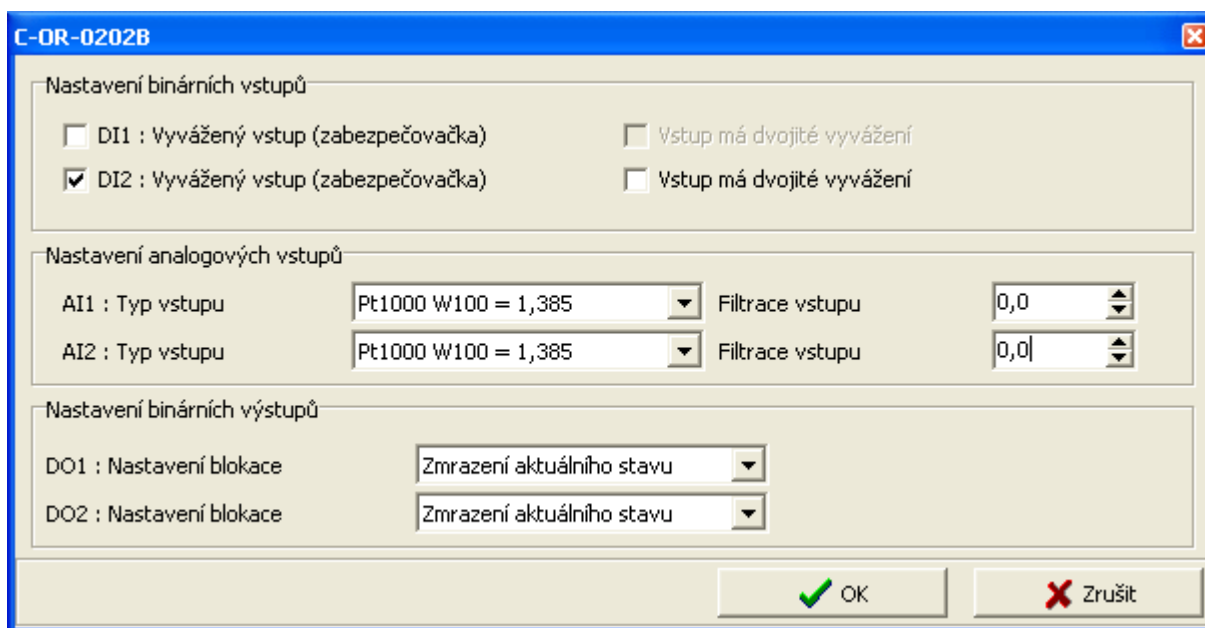

Fig. 3.65 Module configuration

The input terminals DI/AIx are **shared** for binary and analog inputs (for digital and analog equipment). As the input is configured as analog one, **it is not possible** use it as binary input **in the same time**. Depending on the configured input (as enabled devices) specific items of configuration dialog are enabled/disabled. Enabling devices see. chap.2.1 *Master configuration*, check the box *Show units, devices*

Balanced input

By checking the item, the respective input will be evaluated as a simple balanced binary alarm input. If the item is not checked, the respective input evaluated as a normal binary input (on/off).

Double balanced input

By checking the item, respective input will be evaluated as a double balanced binary alarm input. If the item is not checked and the input is configured for security systems (balanced input), the respective input evaluated as alarm input with a simple balance.

Type of input

Choosing the type of analog input:

- Pt1000, $W_{100} = 1,385$, $-90/+320^{\circ}\text{C}$
- Pt1000, $W_{100} = 1,391$, $-90/+320^{\circ}\text{C}$
- Ni1000, $W_{100} = 1,617$, $-60/+200^{\circ}\text{C}$
- Ni1000, $W_{100} = 1,500$, $-60/+200^{\circ}\text{C}$
- NTC 12k (negative thermistor, $12\text{k}\Omega$ at 25°C), $-40/+125^{\circ}\text{C}$
- KTY 81-121, $-55/+125^{\circ}\text{C}$
- OV160k ($0 \div 160\text{k}\Omega$)

Input filtering

By specifying a non-zero value of the time constant, the 1st order digital filter is activated. The filter is given by

$$y_t = \frac{y_{t-1} \cdot \tau + x}{\tau + 1}$$

- x - the current value of the analog input
- y_t - output
- y_{t-1} - recent output
- τ - time constant of the 1st order filter (TAU)

Value of time constant is set in the range 0.1 ÷ 25.4 and it represents a time constant in the range of 100 ms ÷ 25.4 s (value 255 is intended for service purposes).

Blocking of DO

It can be set for binary outputs and for analog output AO1 if they should stay in their last state or they should be disconnected during transition into HALT mode.

3.26.2. The structure of the transmitted data

Module contains 5 devices in total:

- device 1, input, . 1*STAT (status AI)
- device 2, input, 1*AI (analog input 1)
- device 3, input, 1*AI (analog input 2)
- device 4, input, 2*DI
- device 5, output, 2*DO

The devices are incorporated into the structure of the transmitted data, which is evident from window *I/O setting* in the Mosaic. Window is accessible by pressing the icon  in toolbar.













Struktura dat	Úplný zápis	Alias	Svorka	Abs./délka	Hodnota
[-] ID1_IN : TMIQ_CIB1_ID1_IN	MIO_CIB1_IN~ID1_IN				...
[-] STAT : TCIB_AI2_STAT	MIO_CIB1_IN~ID1_IN~STAT				...
OUF1 : BOOL	 MIO_CIB1_IN~ID1_IN~STAT~OUF1			%R144.0	...
VLD1 : BOOL	 MIO_CIB1_IN~ID1_IN~STAT~VLD1			%R144.1	...
OUF2 : BOOL	 MIO_CIB1_IN~ID1_IN~STAT~OUF2			%R144.2	...
VLD2 : BOOL	 MIO_CIB1_IN~ID1_IN~STAT~VLD2			%R144.3	...
AI1 : REAL	 MIO_CIB1_IN~ID1_IN~AI1			%RF145	...
AI2 : REAL	 MIO_CIB1_IN~ID1_IN~AI2			%RF149	...
[-] DI : TCIB_DI2T	MIO_CIB1_IN~ID1_IN~DI				...
DI1 : BOOL	 MIO_CIB1_IN~ID1_IN~DI~DI1			%R153.0	...
DI2 : BOOL	 MIO_CIB1_IN~ID1_IN~DI~DI2			%R153.1	...
TAMPER1 : BOOL	 MIO_CIB1_IN~ID1_IN~DI~TAMPER1			%R153.4	...
TAMPER2 : BOOL	 MIO_CIB1_IN~ID1_IN~DI~TAMPER2			%R153.5	...
[-] ID1_OUT : TMIQ_CIB1_ID1_OUT	MIO_CIB1_OUT~ID1_OUT				...
[-] DOs : TCIB_DO2	MIO_CIB1_OUT~ID1_OUT~DOs				...
DO1 : BOOL	 MIO_CIB1_OUT~ID1_OUT~DOs~DO1			%R154.0	...
DO2 : BOOL	 MIO_CIB1_OUT~ID1_OUT~DOs~DO2			%R154.1	...

Fig. 3.66 The structure of the transmitted data

Input data

STAT	AI1	AI2	DI
------	-----	-----	----

STAT - status byte of analog inputs (8x type bool)

	-	-	-	-	VLD2	OUF2	VLD1	OUF1
Bit	.7	.6	.5	.4	.3	.2	.1	.0

- OUF1 - overflow / underflow of range of analog input AI1
- VLD1 - AI1 analog input reading validity
- OUF2 - overflow / underflow of range of analog input AI2
- VLD2 - AI2 analog input reading validity

AI1 - value of analog input AI1 (type real) [°C],[kΩ]

AI2 - value of analog input AI2 (type real) [°C],[kΩ]

The value of temperature sensor is transferred in °C (with resolution of 0.1°C), the value of general resistance in range 160kΩ is transferred in kΩ (with resolution of 10Ω).

DI - status of binary inputs, signalling "tamper" status of alarm inputs (8x type bool)

	-	-	TAMPER2	TAMPER1	-	-	DI2	DI1
Bit	.7	.6	.5	.4	.3	.2	.1	.0

- DI1 - the current status of the binary DI1/balanced for alarm input1
- DI2 - the current status of the binary DI2/balanced for alarm input 2
- TAMPER1 - tamper status on balanced input 1
- TAMPER2 - tamper status on balanced input 2

Output data

DOs

DOs - value of binary outputs (8x type bool)

	-	-	-	-	-	DO2	DO1	
Bit	.7	.6	.5	.4	.3	.2	.1	.0

- DO1 - value of binary output DO1
- DO2 - value of binary output DO2

3.27. C-RC-0002R

Module in interior design for office and residential interiors is designed to display the current temperature and set the new request temperature. The module thus serves as a simpler variant of the Room Control Manager. Includes 3-digit LCD display, 3 buttons and 1 LED indicator. Internal temperature sensor is integrated in the module. The module also has a universal DI/AI input that can be configured to connect external temperature sensor (e.g. temperature of the floor heating).

Module is designed to be installed on the wall into flush box. The module consists of two parts. The first part contains the interior unit, the second part is used to connect the module to the CIB bus. Both parts are connected to each other by ribbon cable with connector. Signalling green RUN LED is accessible from the side of module opposite to ribbon cable. Connecting on the CIB bus (connection to the power supply) is indicated by permanent lit of the RUN LED. Module operation on the CIB is indicated by regular flashing of the RUN LED.

Module is designed for Time and Element designs of ABB production. For actual offer of designs see the catalogue of Teco

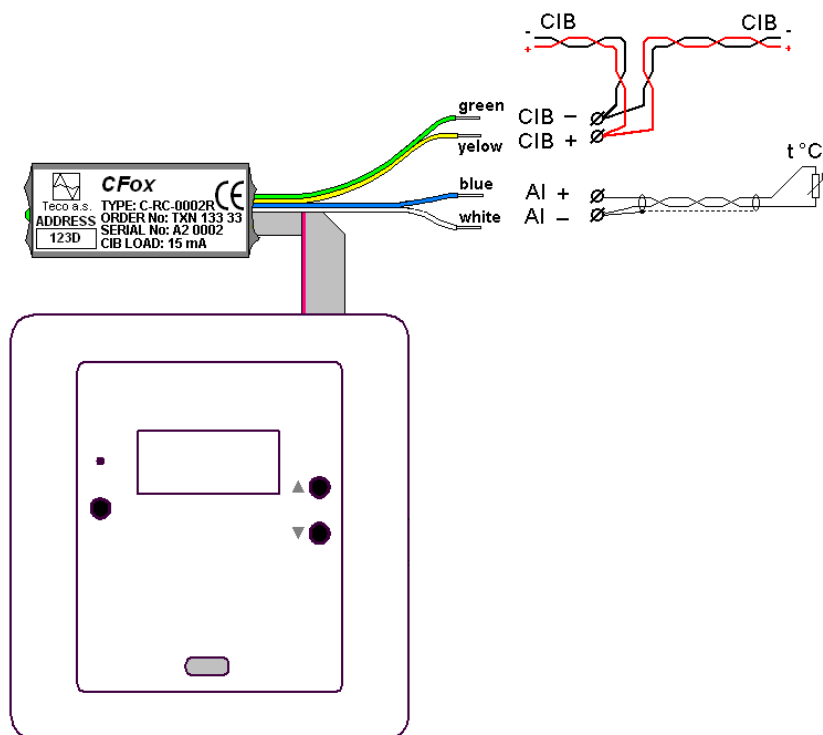

Fig. 3. 67 View and connection C-RC-0002R

Tab. 3.27 Basic parameters C-RC-0002R

Display	
Type	7-segment LCD
Number of digits	3
Buttons	
Quantity	3
Type	Momentary button
LED	
Quantity	1
Colour	Green
Internal thermometer	
Range	0 ÷ +50 °C
Resolution	0.1°C
Measurement error	±0.5°C

Analog input	
Quantity	1
Sensor type	NTC 5k, 10k, 12k, 15k, 20k
Range	0 ÷ +90 °C
Resolution	0.1°C
Measurement error	±0.5°C
Sensor type	OV100k
Range	0 ÷ 100kΩ
Resolution	0.1kΩ pro 0 ÷ 25kΩ 0.2kΩ pro 25 ÷ 50kΩ 0.5kΩ pro 50 ÷ 100kΩ
Measurement error	±0.5kΩ pro 0 ÷ 50kΩ ±1kΩ pro 50 ÷ 100kΩ

Power supply	
Power supply and communication	24 V (27 V) from the CIB
Max. power consumption	15 mA
Dimensions and weight	
Dimensions	
- front panel	83 × 81 × 25mm
- bus coupler	56 × 26 × 16mm
Weight	80g

Operating and installation conditions	
Operating temperature	0 ÷ +50 °C
Storage temperature	-25 ÷ +70 °C
IP degree of protection acc. IEC 529	IP10B
Operating position	Arbitrary
Type of operation	Continuous
Installation	Into the flush box
Connecting	Ribbon cable 0.15mm ²

3.27.1. Configuration

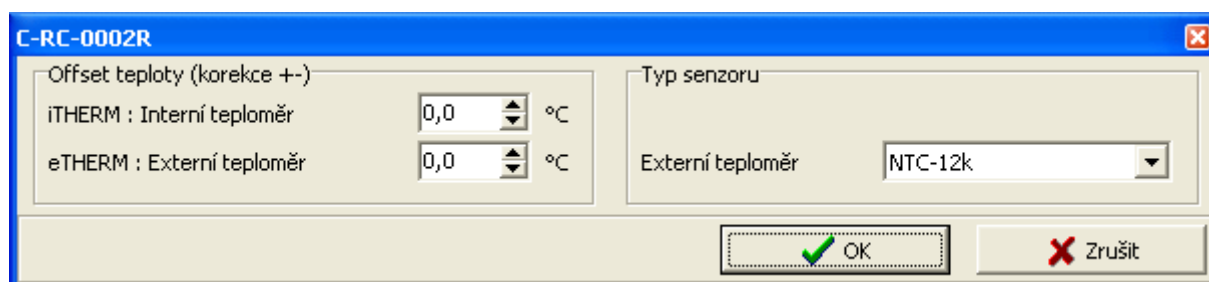

Fig. 3.68 Module configuration

Temperature offset

Correction offset of thermometer, which will be added on the measured temperature.

Sensor type

Choosing type of external analog sensor:

- NTC 5k (negative thermistor, 5kΩ at 25°C), 0/+90°C
- NTC 10k (negative thermistor, 10kΩ at 25°C), 0/+90°C
- NTC 12k (negative thermistor, 12kΩ at 25°C), 0/+90°C
- NTC 15k (negative thermistor, 15kΩ at 25°C), 0/+90°C
- NTC 20k (negative thermistor, 20kΩ at 25°C), 0/+90°C
- OV100k (0 ÷ 100kΩ)

3.27.2. The structure of the transmitted data

Module contains 5 devices in total:

- device 1, input, 1*STAT (status AI)
- device 2, input, 1*AI (internal thermometer)
- device 3, input, 1*AI (external thermometer)
- device 4, input, 3*DI (buttons)
- device 5, input, 1*DISP (display)

The devices are incorporated into the structure of the transmitted data, which is evident from window *I/O setting* in the Mosaic. Window is accessible by pressing the icon  in toolbar.

Struktura dat	Úplný zápis	Alias	Svorka	Abs./délka	Hodnota
ID1_IN : TMIO_CIB1_ID1_IN	MIO_CIB1_IN~ID1_IN				
STAT : TCIB_CRC_STAT	MIO_CIB1_IN~ID1_IN~STAT				\$00
OUF1 : BOOL	MIO_CIB1_IN~ID1_IN~STAT~OUF1			%R224.0	0
VLD1 : BOOL	MIO_CIB1_IN~ID1_IN~STAT~VLD1			%R224.1	0
OUF2 : BOOL	MIO_CIB1_IN~ID1_IN~STAT~OUF2			%R224.2	0
VLD2 : BOOL	MIO_CIB1_IN~ID1_IN~STAT~VLD2			%R224.3	0
DISP : BOOL	MIO_CIB1_IN~ID1_IN~STAT~DISP			%R224.4	0
iTHERM : REAL	MIO_CIB1_IN~ID1_IN~iTHERM			%RF225	0
eTHERM : REAL	MIO_CIB1_IN~ID1_IN~eTHERM			%RF229	0
BTN : TCIB_CRC_BTN	MIO_CIB1_IN~ID1_IN~BTN				\$00
MODE : BOOL	MIO_CIB1_IN~ID1_IN~BTN~MODE			%R233.0	0
DOWN : BOOL	MIO_CIB1_IN~ID1_IN~BTN~DOWN			%R233.1	0
UP : BOOL	MIO_CIB1_IN~ID1_IN~BTN~UP			%R233.2	0
ID1_OUT : TMIO_CIB1_ID1_OUT	MIO_CIB1_OUT~ID1_OUT				
DISP : TCIB_CRC_DISP	MIO_CIB1_OUT~ID1_OUT~DISP				
TEXT : ARRAY [0..2] OF USINT	MIO_CIB1_OUT~ID1_OUT~DISP~TEXT			%R234	0, 0, 0
LED_ON : BOOL	MIO_CIB1_OUT~ID1_OUT~DISP~LED_ON			%R237.0	0
LED_Blink : BOOL	MIO_CIB1_OUT~ID1_OUT~DISP~LED_Blink			%R237.1	0
Disp_OFF : BOOL	MIO_CIB1_OUT~ID1_OUT~DISP~Disp_OFF			%R237.4	0
Disp_Blink : BOOL	MIO_CIB1_OUT~ID1_OUT~DISP~Disp_Blink			%R237.5	0
Dot1 : BOOL	MIO_CIB1_OUT~ID1_OUT~DISP~Dot1			%R237.6	0
Dot2 : BOOL	MIO_CIB1_OUT~ID1_OUT~DISP~Dot2			%R237.7	0

Fig. 3.69 The structure of the transmitted data

Input data

STAT	iTHERM	eTHERM	BTN
------	--------	--------	-----

STAT - status byte of analog inputs (8x type bool)

	-	-	-	-	VLD2	OUF2	VLD1	OUF1
Bit	.7	.6	.5	.4	.3	.2	.1	.0

- OUF1 - overflow / underflow of internal thermometer range
- VLD1 - internal thermometer reading validity
- OUF2 - overflow / underflow of range of external thermometer
- VLD2 - external thermometer reading validity

iTHERM - value of internal thermometer (type real) [°C]

CIB UNITS, MODULES

eTHERM - value of external thermometer (type real) [°C]

The value of temperature sensor is transferred in °C (with resolution of 0.1°C), the value of general resistance in range 100kΩ is transferred in kΩ (with resolution of 0.1/0.2/0.5kΩ).

BTN - status of buttons (8x type bool)

	-	-	-	-	-	UP	DOWN	MODE
Bit	.7	.6	.5	.4	.3	.2	.1	.0

MODE - status of button MODE
DOWN - status of button DOWN
UP - status of button UP

Output data

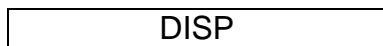

DISP - variables of the LCD display (3x type usint + 6x type bool)

DISP.TEXT - ASCII characters to be displayed (see next chapter)

DISP.LED_ON - LED control

DISP.LED_Blink - flashing of LED (in 150ms raster, at *LED_ON*=1)

DISP.Disp_OFF - turn off the characters displayed on the screen

DISP.Disp_Blink - flashing of displayed characters (in 150ms raster, at *DISP_OFF*=0)

DISP.Dot1 - display 1st decimal point on the display

DISP.Dot2 - display 2nd decimal point on the display

3.27.1. Module specifics

Integrated seven-segment LCD display module allows you to display only a limited set of ASCII characters. Displayable ASCII characters are listed in the following list: ' ', ", ≡, -, 0, 1, 2, 3, 4, 5, 6, 7, 8, 9, =, A, C, E, F, G, H, I, J, L, P, S, U,], °, _, b, c, d, h, i, n, o, r, t, u.

Module mounting

Complete module C-RC-0002R comes disassembled into 4 parts (housing with temperature sensor, intermediate frame, outer frame, set of the panel with display and bus coupler) because the easy installation at the end user site. The assembly process is described in detail in the documentation for the module (TXV 133 33), which is supplied with the module.

3.28. C-RC-0003R

LCD display module in interior design is intended to show the two values (e.g., temperature, humidity,) and four symbols (icons). The module also has a universal DI / AI input that can be configured to connect the contact of the switch button, or for connecting a resistive sensors (e.g. temperature of the floor heating). As a variant, the module can be equipped with internal thermometer, hygrometer and three buttons.

Module is designed to be installed on the wall into flush box. The module consists of two parts. The first part contains the front panel unit (available in several design versions), the second part is used to connect the module to the CIB bus. Both parts are connected to each other by ribbon cable with connector. The green LED indicating the RUN mode is available from the side of the module next to the connector. Connecting on the CIB bus (connection to the power supply) is indicated by permanent lit of the RUN LED. Module operation on the CIB is indicated by regular flashing of the RUN LED.

Module is designed for various designs of wall switches from various manufacturers including EFAPEL, Bticino, LUTRON etc. For actual offer see the catalogue.

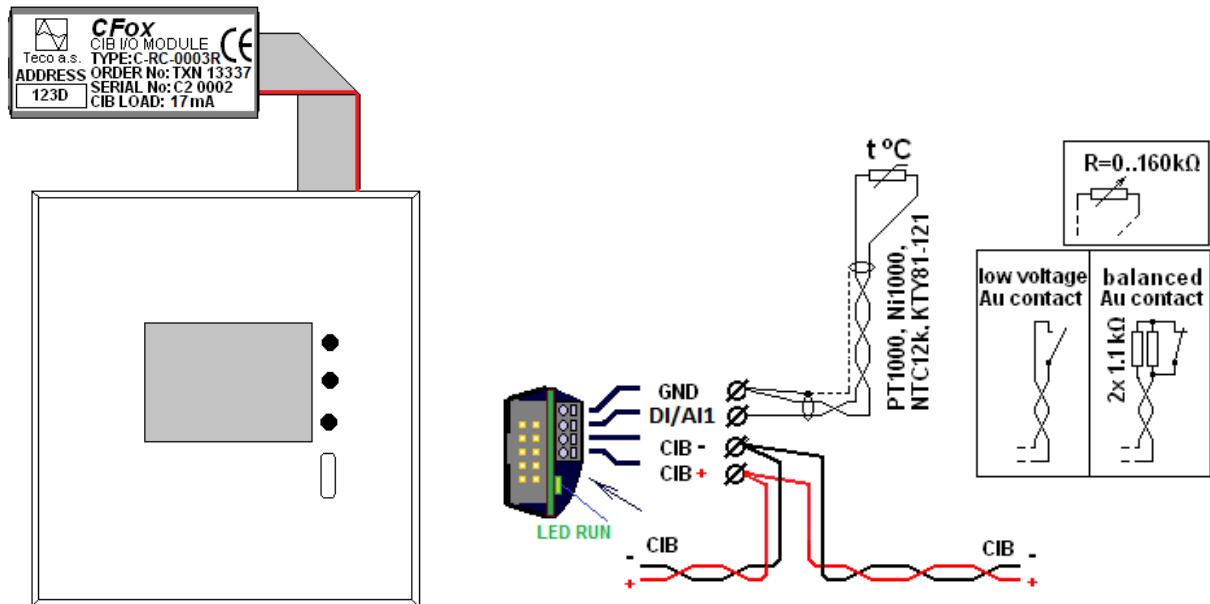

Fig. 3.70 Preview and connection C-RC-0003R

Tab. 3.28 Basic parameters C-RC-0003R

Display	
Type	LCD backlight
Size	27x21mm (98x64pixel)
Number of displayed values	2 + unit symbols
Number of symbols/icons	4
Backlight	continuously adjustable
Buttons (optional)	
quantity	3
Type	Momentary button
Internal thermometer (optional)	
Range	-40 ÷ +125°C
Resolution / accuracy	0.1 °C / typ. 0.3 °C
The period of reading	typically 5s
Internal hygrometer (optional)	
Range	0 ÷ 100% RH
Resolution / accuracy	1% / typ. 2%

Universal input DI/AI	
quantity	1
Optional input type	Binary, Pt1000, Ni1000, NTC12kΩ, KTY81-121, resistance 160kΩ
Binary input	NO contact (0/1) (Normally Open)
Pt1000	-90 ÷ +320 °C
Ni1000	-60 ÷ +200 °C
NTC 12kΩ	-40 ÷ +125 °C
KTY81-121	-55 ÷ +125 °C
Resistor input	0 ÷ 160kΩ
Resolution	0.1 °C / 10Ω
Accuracy	0,5 % of range
The period of reading AI	typically 5s

The period of reading	typically 5s
-----------------------	--------------

Power supply	
Power supply and communication	24 V (27 V) from the CIB
Typical power consumption	10mA (without backlight)
Max. power consumption	17mA
Dimensions and weight	
Dimensions	
- front panel	86 × 86 × 18mm
- bus coupler	42 × 27 × 17mm
Weight	80g

Operating and installation conditions	
Operating temperature	0 ÷ +50 °C
Storage temperature	-25 ÷ +70 °C
IP degree of protection acc. IEC 529	IP10B
Operating position	arbitrary
Type of operation	continuous
Installation	Into the flush box
Connecting the front panel	Ribbon cable 0.15mm ²
Connecting the bus coupler	Spring-loaded terminals, 0.15 ÷ 0.5 mm ²

3.28.1. Configuration

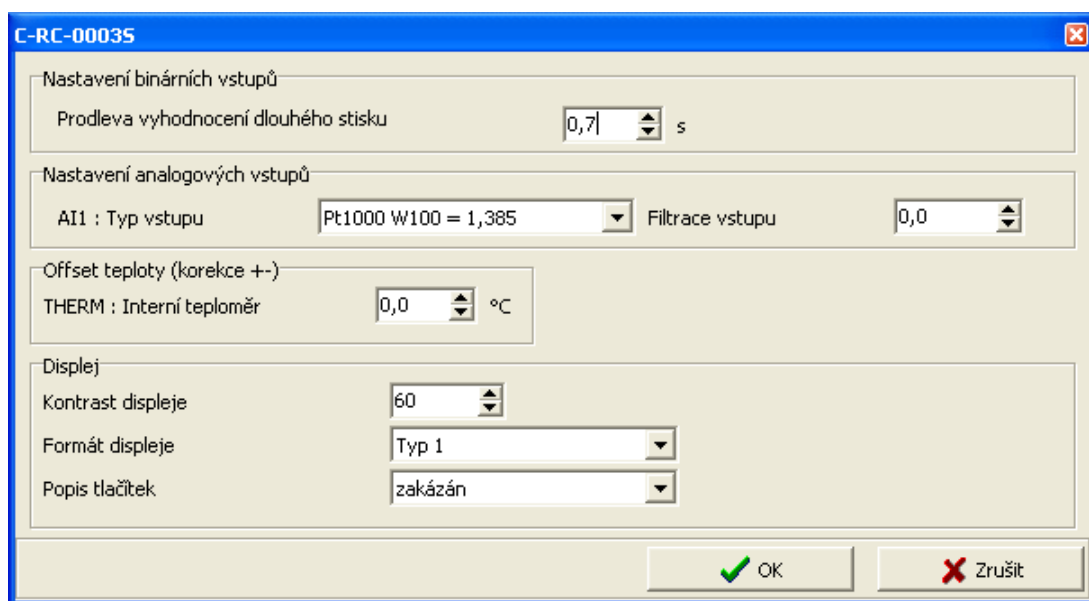

Fig. 3.71 Module configuration

Delay, evaluation of long press

For binary (momentary button) inputs module directly evaluate the short and long presses on each input. By entering values one can set a delay time after which the activation of digital input DI is signalled as the long press (PRESS). Activating the digital input for period shorter than the entered value will be signalled by as the short press (CLICK). Delay period (T_{press}) can be inserted in the range 0.1÷2.5s.

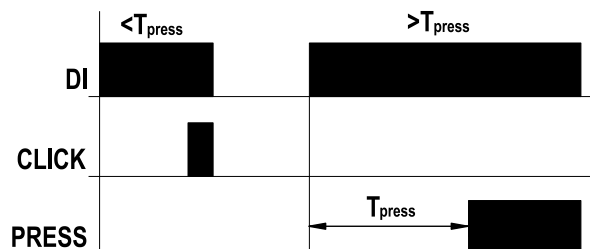

Fig. 3. 72 Evaluation of short/long press

Type of input

Choosing the type of analog input:

- Pt1000, $W_{100} = 1,385, -90/+320^{\circ}\text{C}$
- Pt1000, $W_{100} = 1,391, -90/+320^{\circ}\text{C}$
- Ni1000, $W_{100} = 1,617, -60/+200^{\circ}\text{C}$
- Ni1000, $W_{100} = 1,500, -60/+200^{\circ}\text{C}$
- NTC 12k (negative thermistor, $12\text{k}\Omega$ at 25°C), $-40/+125^{\circ}\text{C}$
- KTY 81-121, $-55/+125^{\circ}\text{C}$
- OV160k ($0 \div 160\text{k}\Omega$)

Input filtering

By specifying a non-zero value of the time constant, the 1st order digital filter is activated. The filter is given by

$$y_t = \frac{y_{t-1} \cdot \tau + x}{\tau + 1}$$

- x - the current value of the analog input
- y_t - output
- y_{t-1} - recent output
- τ -time constant of the 1st order filter (TAU)

Value of time constant is set in the range $0.1 \div 25.4$ and it represents a time constant in the range of $100 \text{ ms} \div 25.4 \text{ s}$ (value 255 is intended for service purposes).

Temperature offset

Correction offset of thermometer, which will be added on the measured temperature.

Display contrast

Setting the display contrast, in the range 0 to 127 (0 - low contrast, 127 - high contrast).

Display layout

Graphical layout of the content of the display can be changed by the user. There is a choice of two options, *Type1* or *Type2*. Layout of the display is depicted below. .

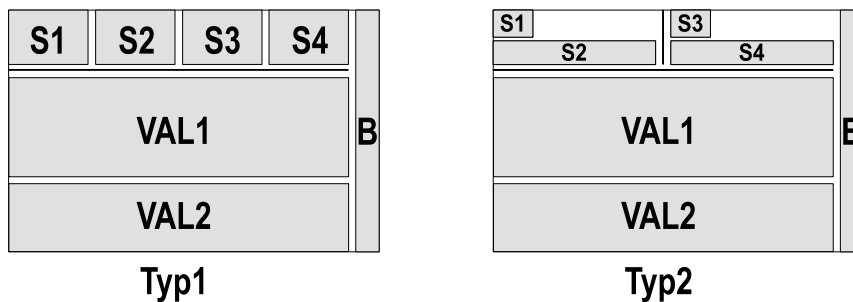

- S1÷S4 - view symbols / modes
- VAL1 - primary value including the unit
- VAL2 - secondary value including the unit
- B - button labels

Button labels

Checking the box, the labels of each button will be displayed in B area.

3.28.2. The structure of the transmitted data

Module contains 6 devices in total:

- device 1, input, 3*BUTT + 1*DI (button + DI1)
- device 2, input, 1*DISP (display)
- device 3, input, 1*STAT (status AI)
- device 4, input, 1*AI (internal thermometer)
- device 5, input, 1*AI (internal hygrometer)
- device 6, input, 1*AI (AI1)

The devices are incorporated into the structure of the transmitted data, which is evident from the panel *I/O settings* in Mosaic. Panel is available by clicking on the icon  in the toolbar.

Struktura dat	Úplný zápis	Alias	Svorka	Abs./délka	Hodnota
[-] ID1_IN : TMI_CIB1_ID1_IN	MI_CIB1_IN~ID1_IN				
[-] di : TCIB_CRC0003S_BTN	MI_CIB1_IN~ID1_IN~di			%R4 / 2	\$0000
[-] stat : TCIB_CRC0003S_STAT	MI_CIB1_IN~ID1_IN~stat			%R6 / 1	\$00
- THERM : REAL	MI_CIB1_IN~ID1_IN~THERM			%RF7	0
- RH : REAL	MI_CIB1_IN~ID1_IN~RH			%RF11	0
- AI : REAL	MI_CIB1_IN~ID1_IN~AI			%RF15	0
[-] ID1_OUT : TMI_CIB1_ID1_OUT	MI_CIB1_OUT~ID1_OUT				
[-] disp : TCIB_CRC0003S_DISP	MI_CIB1_OUT~ID1_OUT~disp				
[-] cont : TCIB_CRC0003S_CO	MI_CIB1_OUT~ID1_OUT~disp~cont			%R19 / 0	\$00
- val1 : INT	MI_CIB1_OUT~ID1_OUT~disp~val1			%RW20	0
- val2 : INT	MI_CIB1_OUT~ID1_OUT~disp~val2			%RW22	0
- symbols : WORD	MI_CIB1_OUT~ID1_OUT~disp~symbols			%RW24	
- units1 : BYTE	MI_CIB1_OUT~ID1_OUT~disp~units1			%R26	0
- units2 : BYTE	MI_CIB1_OUT~ID1_OUT~disp~units2			%R27	0
- light : BYTE	MI_CIB1_OUT~ID1_OUT~disp~light			%R28	0

Fig. 3.73 The structure of the transmitted data

Input data

DI	STAT	THERM	RH	AI1
----	------	-------	----	-----

DI - button/binary inputs status (16x type bool)

	DI1	BUT3	BUT2	BUT1
Bit	.3	.2	.1	.0
	CLICK_DI1	CLICK_BUT3	CLICK_BUT2	CLICK_BUT1
Bit	.7	.6	.5	.4

	PRES_DI1	PRESS_BUT3	PRESS_BUT2	PRESS_BUT1
Bit	.11	.10	.9	.8

	-	-	-	-
Bit	.15	.14	.13	.12

- BUTx - the current status of the BUTx button
- DI1 - the current status of the binary DI1 input
- CLICK_BUTx - short press of the BUTx button
- CLICK_DI1 - short press on the DI1 input
- PRESS_BUTx - long press of the BUTx button
- PRESS_DI1 - long press on the DI1 input

STAT - status byte of analog inputs (8x type bool)

	-	-	VLD1	OUF1	VLDR	OUF1	VLDT	OUF1
Bit	.7	.6	.5	.4	.3	.2	.1	.0

- OUF1 - overflow / underflow of thermometer range
- VLDT - thermometer reading validity
- OUF2 - overflow / underflow of hygrometer range
- VLDR - hygrometer reading validity
- OUF1 - overflow / underflow of analog input AI1
- VLD1 - AI1 analog input reading validity

- THERM* - temperature (1x type real) [°C]
- RH* - relative humidity (1x type real) [%]
- AI1* - value of analog input AI1 (1x type real) [°C],[kΩ]

The value of temperature sensor is transferred in °C (with resolution of 0.1°C), the value of general resistance in range 160kΩ is transferred in kΩ (with resolution of 10Ω).

Input data

DISP

DISP - output data zone of the display

DISP.CONT - control word of display (8x type bool)

	blinkS4	blinkS3	blinkS2	blinkS1	blink22	blink21	blink12	blink11
Bit	.7	.6	.5	.4	.3	.2	.1	.0

- blinkSx* - blinking of respective symbols Sx
 0 - does not flash
 1 - flash

- blink1x* - blinking of individual digits of the value VAL1
- blink2x* - blinking of individual digits of the value VAL2

CIB UNITS, MODULES

0x00 - does not flash
 0x01 - flashing lower 2 digits (Low)
 0x10 - flashing higher 2 digits (High)
 0x11 - flashing all digits
 Flashing is in 500ms period.

DISP.VAL1 - primary value is displayed in the range -9999 ÷ +9999 (1x type int)





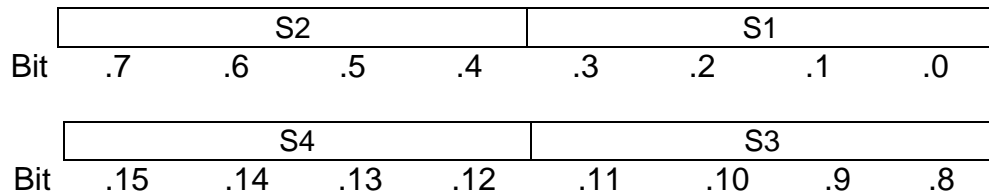











DISP.VAL2 - secondary value is displayed in the range -9999 ÷ +9999 (1x type int)

DISP.SYMBOLS - display symbols(1x type word)



- S1 - display symbol / mode S1
- S2 - display symbol / mode S2
- S3 - display symbol / mode S3
- S4 - display symbol / mode S4

The specific form of the symbol of displayed/selected mode is given by *display format*, see chapter *Configuration*.

	Type1	Type2	
	S1÷S4	S1,S3	S2,S4
0x00			
0x01			OFF
0x02			Heat
0x03			Cool
0x04			Auto
0x05			Fan
0x06			Dry
0x07			On
0x08			Cycle
0x09			High
0x0A			Medium
0x0B			Low
0x0C			Top
0x0D			
0x0E			
0x0F			

3.28. C-RC-0003R

DISP.UNITS1 - units and display format of primary value (1x type usint)

DISP.UNITS2 - units and display format of secondary value (1x type usint)

	FORM		UNIT					
Bit	.7	.6	.5	.4	.3	.2	.1	.0

- FORM - display format
0x00 - with a decimal point (xxx.x)
0x01 - without a decimal point (xxxx)
0x10 - with a colon, time format (xx:xx)
0x11 -
- UNIT - unit displayed
0x00 -
0x01 - °C
0x02 - °F
0x03 - %
0x04 - rH
0x05 - kW
0x06 - ppm
0x07 - time symbol, "hourglass"

DISP.LIGHT - display backlight (1x type usint)

	BLINK	VAL						
Bit	.7	.6	.5	.4	.3	.2	.1	.0

- BLINK - flashing backlight (in 500ms period)
0 - does not flash
1 - flash
- VAL - level of display backlight, 0÷100[%]

3.29. C-RI-0401S

The module contains 1 output of IR (infrared) transmitter, 1 input of IR receiver demodulator, 1 input for light intensity sensor (BPW21), one output LED indicator and 2 universal inputs. Each of the universal inputs can be used by either the potential-free binary input or the analog input for connecting a resistance temperature sensor.

The mechanical design of the module is designed to be mounted under cover of device (ingress protection of the module IP10B). Signals of the module are available on ribbon cable. signalling green RUN LED is accessible from the side of module opposite to ribbon cable. Connecting on the CIB bus (connection to the power supply) is indicated by permanent lit of the RUN LED. Module operation on the CIB is indicated by regular flashing of the RUN LED.

For sensors Pt1000, Ni1000, KTY81-121, and sensor TC and TZ (thermistor NTC12k) module performs the conversion and linearization of measured values directly to temperature. For other types of resistors (in range 0 to 160 kΩ) the conversion to the temperature has to be done in user program in CPU (module gives the value in kΩ, with resolution 10 Ω).

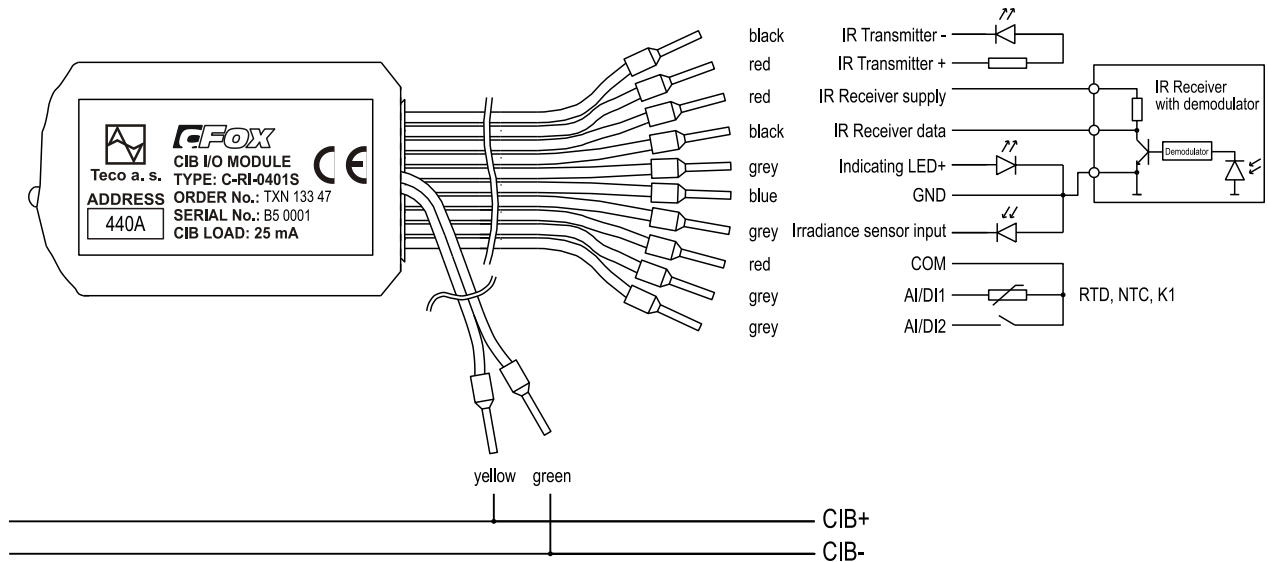

Fig. 3. 74 View and connection C-RI-0401S

3.29. C-RI-0401S

Tab. 3.29 Basic parameters C-RI-0401S

Universal DI/AI inputs	
Quantity	2
Optional types of inputs	Binary, Pt1000, Ni1000, NTC12kΩ, KTY81-121, resistance 160kΩ
Binary input	NO contact (0/1) (Normally Open)
Pt1000	-90 ÷ +320 °C
Ni1000	-60 ÷ +200 °C
NTC 12kΩ	-40 ÷ +125 °C
KTY81-121	-55 ÷ +125 °C
Resistance input	0 ÷ 160kΩ
Resolution	0.1 °C / 10Ω
Accuracy	2 %

Power supply	
Power supply and communication	24 V (27 V) from the CIB
Max. power consumption	25 mA
Dimensions and weight	
Dimensions	55 × 32 × 13mm
Weight	8g

Input of light intensity sensor	
Quantity, type of sensor	1, photodiode BPW21
Range of measurement	0 ÷ 50000 lx
Accuracy of measurement	5 %
Input of IR receiver demodulator	
Quantity	1
Power supply for demodulator	3.3 V
Demodulator pilot frequency	36 kHz
Output of IR transmitter	
Quantity	1
Power supply of transmitter	3.3 V
Type of IR transmitter	IR LED ($I_{FMAX} = 100mA$) + resistor according to I_F (e.g. for IR LED $U_F = 1.2V$, $I_F = 20mA \rightarrow R = 100\Omega$)
Operating and installation conditions	
Operating temperature	-10 ÷ +55 °C
Storage temperature	-25 ÷ +70 °C
IP degree of protection acc. IEC 529	IP10B
Operating position	Arbitrary
Type of operation	Continuous
Installation	under cover of device
Connecting	Ribbon cable 0.15mm ² (CIB) removable connectors with separated wires 0.14 mm ² /10cm

3.29.1. Configuration

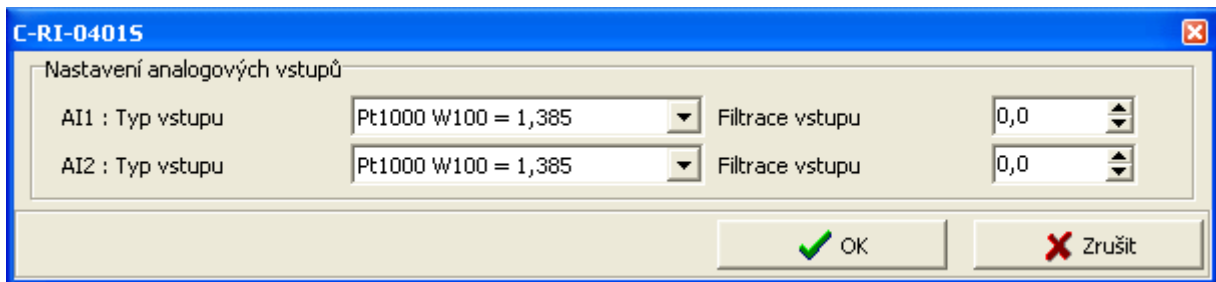

Fig. 3.75 Module configuration

The input terminals DI/AIx are **shared** for binary and analog inputs (for digital and analog equipment). As the input is configured as analog one, **it is not possible** use it as binary input **in the same time**. Depending on the configured input (as enabled devices) specific items of configuration dialog are enabled/disabled. Enabling devices see. chap.2.1 *Master configuration*, check the box *Show units, devices*

Type of input

Choosing the type of analog input:

- Pt1000, $W_{100} = 1,385$, -90/+320°C
- Pt1000, $W_{100} = 1,391$, -90/+320°C
- Ni1000, $W_{100} = 1,617$, -60/+200°C

Ni1000, $W_{100} = 1,500, -60/+200^{\circ}\text{C}$
 NTC 12k (negative thermistor, $12\text{k}\Omega$ at 25°C), $-40/+125^{\circ}\text{C}$
 KTY 81-121, $-55/+125^{\circ}\text{C}$
 OV160k ($0 \div 160\text{k}\Omega$)

Input filtering

By specifying a non-zero value of the time constant, the 1st order digital filter is activated. The filter is given by

$$y_t = \frac{y_{t-1} \cdot \tau + x}{\tau + 1}$$

- x - the current value of the analog input
- y_t - output
- y_{t-1} - recent output
- τ -time constant of the 1st order filter (TAU)

Value of time constant is set in the range $0.1 \div 25.4$ and it represents a time constant in the range of $100 \text{ ms} \div 25.4 \text{ s}$ (value 255 is intended for service purposes).

3.29.2. The structure of the transmitted data

Module contains 6 devices in total:

- device 1, input, **1*STAT** (status AIx, light intensity sensor)
- device 2, input, **2*AI** (thermometers)
- device 3, input, **1*AI** (light intensity sensor)
- device 4, input, **2*DI**
- device 5, input/output, **1*IRI/IRO** (infrared receiver/transmitter)

The devices are incorporated into the structure of the transmitted data, which is evident from window *I/O setting* in the Mosaic. Window is accessible by pressing the icon  in toolbar.

Struktura dat	Úplný zápis	Alias	Svorka	Abs./délka	Hodnota
[-] ID1_IN : TMIO_CIB1_ID1_IN	MIO_CIB1_IN~ID1_IN				
[+] STAT : TCIB_RI_STAT	MIO_CIB1_IN~ID1_IN~STAT			%R212 / 1	\$00
[+] THERM : TCIB_RI_THERM	MIO_CIB1_IN~ID1_IN~THERM			%R213 / 8	
light : UINT	MIO_CIB1_IN~ID1_IN~light			%RW221	\$0000
[+] DI : TCIB_DI2	MIO_CIB1_IN~ID1_IN~DI			%R223 / 1	\$00
[-] IRin : TCIB_IRin	MIO_CIB1_IN~ID1_IN~IRin				
[+] stat : TCIB_RI_STAT	MIO_CIB1_IN~ID1_IN~IRin~stat			%R224 / 0	\$00
IR_code : UINT	MIO_CIB1_IN~ID1_IN~IRin~IR_code			%RW225	0
[-] ID1_OUT : TMIO_CIB1_ID1_OUT	MIO_CIB1_OUT~ID1_OUT				
[-] IRout : TCIB_IRout	MIO_CIB1_OUT~ID1_OUT~IRout				
[+] cont : TCIB_IRControl	MIO_CIB1_OUT~ID1_OUT~IRout~cont			%R227 / 0	\$00
IR_code : UINT	MIO_CIB1_OUT~ID1_OUT~IRout~IR_coc			%RW228	0

Fig. 3.76 The structure of the transmitted data

Input data

STAT	THERM	light	DI	Irin
------	-------	-------	----	------

STAT - status byte of analog inputs (8x type bool)

	-	-	VLDI	OUI	VLD2	OUI2	VLD1	OUI1
Bit	.7	.6	.5	.4	.3	.2	.1	.0

- OUI1 - overflow / underflow of range of analog input AI1
- VLD1 - AI1 analog input reading validity
- OUI2 - overflow / underflow of range of analog input AI2
- VLD2 - AI2 analog input reading validity
- OUI - overflow/underflow of range of light intensity sensor
- VLDI - validity of the reading of input with the light intensity sensor

THERM.AIx - value of analog input AIx (2x type real) [°C],[kΩ]

The value of temperature sensor is transferred in °C (with resolution of 0.1°C), the value of general resistance in range 160kΩ is transferred in kΩ (with resolution of 10Ω).

Light - value of the light intensity (1x type uint) [lx]

DI - status of binary inputs (8x type bool)

	-	-	-	-	-	-	DI2	DI1
Bit	.7	.6	.5	.4	.3	.2	.1	.0

- DI1 - the current status of the binary DI1 input
- DI2 - the current status of the binary DI2 input

Irin.stat - status byte of IR receiver (8x type bool)

- Receive_End - receiving of IR packet finished
- Err_Receive - IR packet reception error (unknown, unlearned packet)
- Transmit_End - sending IR packet is complete
- Learn_End - Learning IR packet is complete
- Err_Learn - error when learning IR packet
- Clear_End - deleting learned IR packet is complete
- ErrMode - invalid mode (in *Ircont.out*)

Irin.IR_code - index of received IR packet (1x type uint)

Output data

IROUT

IROUT.cont - control byte of IR transmitter (8x type bool)

- Receive_ON - Activation the IR receiving
- Transmit_ON - Activation the IR transmitting

Learn_ON	- Activation the IR learning mode
Learn_Mask	- reserve
Clear	- Activation of IR deleting mode
LED_AUTO	- automatic flashing LED when receiving IR packet = 1 - 1x long flash in the successful IR reception - 3x short flashes during a failed IR reception = 0 - manual control of LED (bits <i>LED_ON</i> and <i>LED_Blink</i>)
LED_ON	- status of LED indicator, 0/1 = off / on
LED_Blink	- flashing of LED (in 150ms raster, at LED_ON=1)

Irout.IR_code - index of transmitted IR packet (1x type uint)

3.29.3. Description of function IR receiver / transmitter

IR receiver and IR transmitter in module are designed to capture and generate IR signal from the IR remote controllers, using the control of different types of appliances (e.g. air conditioners). The module can handle any IR signal (packet) sent from the IR remote controller that works with a carrier frequency of 36kHz. The captured IR packet from the remote control can be learned/saved and consequently reproduced (transmitted). This makes it possible to replace the original manual control via IR remote control by automated control over C-RI-0401S module. The module allows you to save about. 100 different IR packets/commands.

IR learning procedure

Learning procedure is initiated by setting the index of learned packet to *Irout.IR_code* variable (packet index must not be 0 (0x0000) and/or 65535 (0xFFFF) - they are dedicated values!!!). Then the variable *Irout.cont.Learn_On* has to be set on 1 so the module turns to the receiving state and awaits the IR packet to be learned..

Successful reception and processing of learned packet is signalled by setting the variable *Irin.stat.Learn_End* = 1. In case of unsuccessful packet teaching cycle also the variable *Irin.stat.Err_Learn* = 1 is set and the learning procedure must be repeated.

Termination (reset) of the enrolment is done by setting the variable *Irout.cont.Learn_On* = 0, thus the flags *Irin.stat.Learn_End* and *Irin.stat.Err_Learn* are cleared in status byte. Learning another IR packet is re-activated by setting the variable *Irout.cont.Learn_On* = 1.

Learned IR packets are stored in the module and the ON / OFF power module.

IR receiving

In this mode, the module receives learned IR packets. Activation of IR reception is done by setting the variable *Irout.cont.Receive_On* = 1. The module goes into receiving mode and waits for coming IR packet.

Successful acceptance of learned packet is signalled by setting the variable *Irin.stat.Receive_End* = 1 and setting the index of the received packet in the variable *Irin.IR_code*. If the module accepts unknown packet (which is not taught in the module) also the variable is set *Irin.stat.Err_Receive* = 1 and variable *Irin.IR_code* = 0.

Termination (reset) of the receiving mode can be done by setting the variable *Irout.cont.Receive_On* = 0, which clear the flags *Irin.stat.Receive_End* and *Irin.stat.Err_Receive* in the status byte and variable *Irin.IR_code*. Receiving another IR packet is activated by setting the variable *Irout.cont.Receive_On* = 1.

IR transmitting

For transmitting of IR packet the index of the desired packet must be set first into the variable *lrout.IR_code*. Transmitting of the desired packet is started by setting the variable *lrout.cont.TransmitOn* = 1. End of transmitting the whole packet is indicated by setting variable *lrin.stat.Transmit_End* = 1.

Termination (reset) of the transmitting mode can be done by setting the variable *lrout.cont.TransmitOn* = 0, which clear the flag *lrin.stat.Transmit_End*. Transmitting of another IR packet is activated by setting the variable *lrout.cont.TransmitOn* = 1.

IR clearing

To delete a learned IR packet from the module the index of deleting packet has to be set to variable *lrout.IR_code* and then the variable *lrout.cont.Clear* = 1 is set. Clearing the IR packet is signaled by setting the variable *lrin.stat.Clear_End* = 1. If you want to erase all learned IR packets at the same time, it is possible to set the value 65535 (0xFFFF) into a variable *lrout.IR_code*.

Termination (reset) of deleting is done by setting the variable *lrout.cont.Clear* = 0, which clear the flag *lrin.stat.Clear_End* from the status byte. Next deleting can be done by re-setting the variable *lrout.cont.Clear* = 1.

It is not necessary to delete the original learned IR packet, the index is rewritten by the new learned IR packet.

3.30. C-WG-0503S

The module is designed to connect readers of contactless RFID identifiers that communicate via Wiegand interface (e.g. Aktion AXR-100 from EFG CZ spol. Ltd., or Samsung SSA-R1001, SSA-R2000V or others). In addition to the signal from the card readers the module also contains one binary input for potential-free contacts, two universal inputs and 3 digital outputs (OC).

Each of the universal inputs can be used either as the binary input for potential free contacts or as a balanced input for alarm detectors (security systems) or as the analog input for connecting a resistance or temperature sensor. Inputs for the reader can be reconfigured to function of 2 binary inputs. The module can therefore operate either in a configuration Wiegand + 1*DI + 2*AI/DI + 3*DO or in configuration 3*DI + 2*AI/DI + 3*DO.

The mechanical design of the module is designed to be mounted under cover of device (ingress protection of the module IP10B). Signals of module are led out by removable connectors with separated wires.

The green LED indicating the RUN mode is available from the side of the module opposite to the connectors. Connecting on the CIB bus (connection to the power supply) is indicated by permanent lit of the RUN LED. Module operation on the CIB is indicated by regular flashing of the RUN LED.

For sensors Pt1000, Ni1000, KTY81-121, and sensor TC and TZ (thermistor NTC12k) module performs the conversion and linearization of measured values directly to temperature. For other types of resistors (in range 0 to 160 kΩ) the conversion to the temperature has to be done in user program in CPU (module gives the value in kΩ, with resolution 10 Ω).

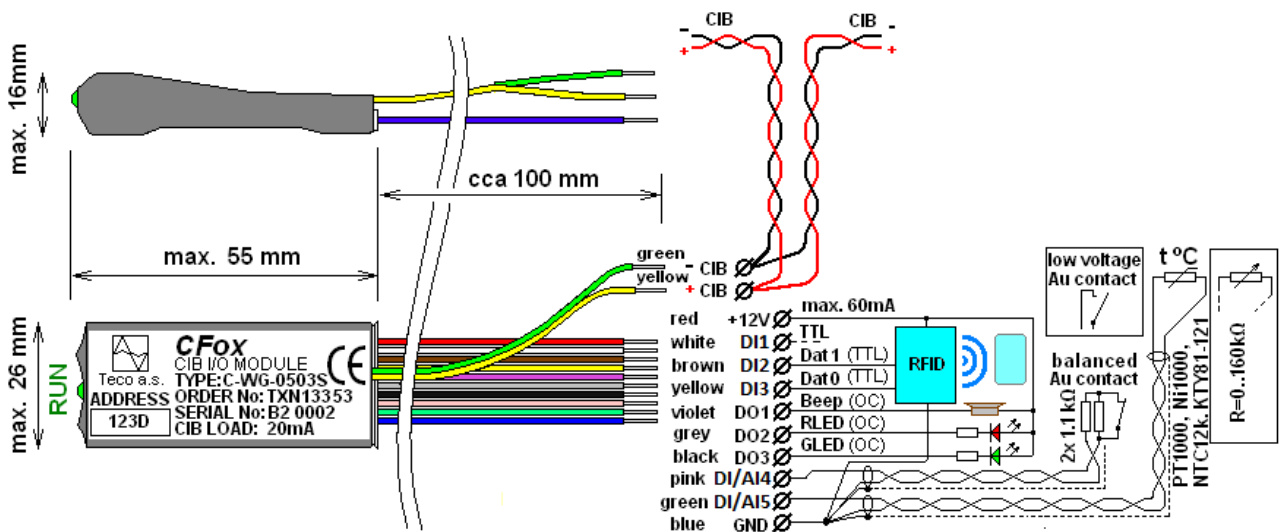

Fig. 3. 77 View and connection C-WG-0503S

Tab. 3.30 Basic parameters C-WG-0503S

Wiegand inputs, Binary inputs (DI1,DI2,DI3)	
Quantity	3
Type	TTL 5V
Pull -up resistance	3.9kΩ
Galvanic isolation	No
Wiegand interface	26/34/42 bit (3/4/5 B)
- Pulse width / delay	typ. 60÷100us / 1÷2ms
Binary outputs (DO1,DO2,DO3)	
Quantity	3
Type	Open collector NPN
Switched voltage	max. 30V
Switched current	max. 30mA
Galvanic isolation	No

Power supply	
Power supply and communication	24 V (27 V) from the CIB
Nominal power consumption	20 mA
Max. power consumption	85 mA
Operating and installation conditions	
Operating temperature	0 ÷ +70 °C
Storage temperature	-25 ÷ +85 °C
IP degree of protection acc. IEC 529	IP10B
Overvoltage category	II (according to EN 60664)
Degree of pollution	1 (according to EN 60664)
Operating position	Arbitrary
Type of operation	Continuous

Universal inputs DI/AI/EZS (DI/AI4, DI/AI5)	
Quantity	2
Optional types of universal inputs	Binary, balanced, 1x2k2, 2x1k1, Pt1000, Ni1000, NTC12kΩ, KTY81-121, resistance 160kΩ
Threshold level of DI	0...>1.5kΩ, 1...<0.5kΩ
Internal voltage DI	3.3V
Internal resistance of DI	2.2kΩ
Resolution AI	0.1 °C / 10Ω
Accuracy AI	0,5 %
Galvanic isolation	No

Power output	
Output voltage	12V DC
Output current	max. 60mA
The period of data refresh	
Analog inputs	typically 5s
Other inputs	typically 160ms
Dimensions and weight	
Dimensions	max. 55 × 26 × 16mm
Weight	7 g
Installation	
Type	under cover of device
Connecting	Ribbon cable 0.15mm ² (CIB) removable connectors with separated wires 0.14 mm ² /10cm

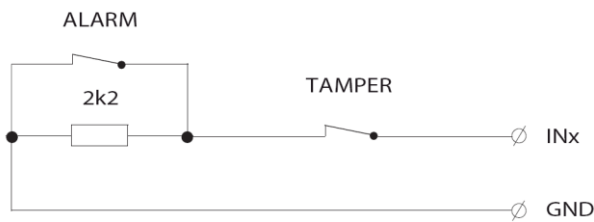

Fig. 3. 78 Simply balanced input for security detectors

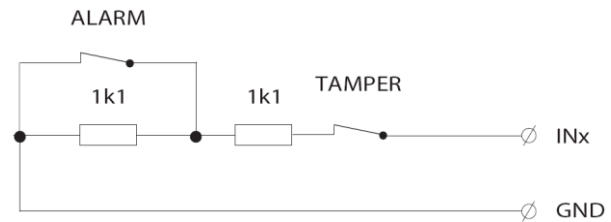

Fig. 3. 79 Double-balanced input for security detectors

3.30.1. Configuration

Fig. 3.80 Module configuration

Some inputs, input terminals are **shared** for more functions of module. Wiegand data inputs are shared with DI, universal inputs are shared for DI/AI. If the inputs are configured to connect data lines of Wiegand reader **it is not possible** to use them **in the same time** as DI. Likewise, universal input configured as AI **cannot be used in the same time** as DI. Depending on the configured input (as enabled devices) specific items of configuration dialog are enabled/disabled. Enabling devices see. chap. [2.1 Master configuration](#), check the box *Show units, devices*.

Type of encoding

Primary the module allows processing codes of protocol of Wiegand 26, Wiegand 34 or 42 bit Wiegand. The module automatically detects the type of protocol and checks the frames (security) and transmits only "pure" code identifier to the user. Secondary the module can be switched into so called "transparent" mode, where the "rough" identifier code is forwarded to the user (without framework and security checking) in lengths up to 5 flats (longer code is cut off). Required type of encoding is set by checking the appropriate item.

Balanced input

By checking the item, the respective input will be evaluated as a simple balanced binary alarm input. If the item is not checked, the respective input evaluated as a normal binary input (on/off).

Double balanced input

By checking the item, respective input will be evaluated as a double balanced binary alarm input. If the item is not checked and the input is configured for security systems (balanced input), the respective input evaluated as alarm input with a simple balance.

Type of input

Choosing the type of analog input:

Pt1000, $W_{100} = 1,385$, -90/+320°C

Pt1000, $W_{100} = 1,391$, -90/+320°C

Ni1000, $W_{100} = 1,617$, -60/+200°C

Ni1000, $W_{100} = 1,500$, -60/+200°C

NTC 12k (negative thermistor, 12kΩ at 25°C), -40/+125°C

KTY 81-121, -55/+125°C

OV160k (0 ÷ 160kΩ)

Input filtering

By specifying a non-zero value of the time constant, the 1st order digital filter is activated. The filter is given by

$$y_t = \frac{y_{t-1} \cdot \tau + x}{\tau + 1}$$

- x - the current value of the analog input
- y_t - output
- y_{t-1} - recent output
- τ -time constant of the 1st order filter (TAU)

Value of time constant is set in the range 0.1 ÷ 25.4 and it represents a time constant in the range of 100 ms ÷ 25.4 s (value 255 is intended for service purposes).

Blocking of DO

It can be set for binary outputs DOx if they should stay in their last state or they should be disconnected during transition into HALT mode.

3.30.1. The structure of the transmitted data

Module contains 5 devices in total:

- device 1, input/output, 1*CODE/3*DO (reader/indication)
- device 2, input, 1*STAT (status AIx)
- device 3, input, 1*AI (input AI4)
- device 4, input, 1*AI (input AI5)
- device 5, input, 3*DI+2*DI/EZS

The devices are incorporated into the structure of the transmitted data, which is evident from window *I/O setting* in the Mosaic. Panel is available after pressing icon  in toolbar.

CIB UNITS, MODULES

Struktura dat	Úplný zápis	Alias	Svorka	Abs./délka	Hodnota
▣ ID1_IN : TMIO_CIB1_ID1_IN	MIO_CIB1_IN~ID1_IN				
▣ CODE : TCIB_CWG0503S_CODE	MIO_CIB1_IN~ID1_IN~CODE				
STAT : USINT	MIO_CIB1_IN~ID1_IN~CODE~STAT			%R144	0
VAL : ARRAY [0..4] OF USINT	MIO_CIB1_IN~ID1_IN~CODE~VAL			%R145	0, 0, 0, 0, 0
▣ STAT : TCIB_CWG0503S_STAT	MIO_CIB1_IN~ID1_IN~STAT				\$00
OUF4 : BOOL	MIO_CIB1_IN~ID1_IN~STAT~OUF4			%R150.0	0
VLD4 : BOOL	MIO_CIB1_IN~ID1_IN~STAT~VLD4			%R150.1	0
OUF5 : BOOL	MIO_CIB1_IN~ID1_IN~STAT~OUF5			%R150.2	0
VLD5 : BOOL	MIO_CIB1_IN~ID1_IN~STAT~VLD5			%R150.3	0
AI4 : REAL	MIO_CIB1_IN~ID1_IN~AI4			%RF151	0
AI5 : REAL	MIO_CIB1_IN~ID1_IN~AI5			%RF155	0
▣ DI : TCIB_CWG0503S_DI	MIO_CIB1_IN~ID1_IN~DI				
DI1 : BOOL	MIO_CIB1_IN~ID1_IN~DI~DI1			%R159.0	0
DI2 : BOOL	MIO_CIB1_IN~ID1_IN~DI~DI2			%R159.1	0
DI3 : BOOL	MIO_CIB1_IN~ID1_IN~DI~DI3			%R159.2	0
DI4 : BOOL	MIO_CIB1_IN~ID1_IN~DI~DI4			%R159.3	0
DI5 : BOOL	MIO_CIB1_IN~ID1_IN~DI~DI5			%R159.4	0
TAMPER4 : BOOL	MIO_CIB1_IN~ID1_IN~DI~TAMPER4			%R159.5	0
TAMPERS : BOOL	MIO_CIB1_IN~ID1_IN~DI~TAMPERS			%R159.6	0
▣ ID1_OUT : TMIO_CIB1_ID1_OUT	MIO_CIB1_OUT~ID1_OUT				\$00
▣ DOs : TCIB_DO3	MIO_CIB1_OUT~ID1_OUT~DOs				\$00
DO1 : BOOL	MIO_CIB1_OUT~ID1_OUT~DOs~DO1			%R160.0	0
DO2 : BOOL	MIO_CIB1_OUT~ID1_OUT~DOs~DO2			%R160.1	0
DO3 : BOOL	MIO_CIB1_OUT~ID1_OUT~DOs~DO3			%R160.2	0

Fig. 3.81 The structure of the transmitted data

Input data

CODE	STAT	AI4	AI5	DI
------	------	-----	-----	----

CODE.STAT - status byte of received identification code (1x type usint)

- = 1 - code in format transparent 40-bit was accepted
- = 3 - code in format Wiegand 26 was accepted
- = 4 - code in format Wiegand 34 was accepted
- = 5 - code in format Wiegand 42 was accepted

CODE.VAL - received identification code (5x type usint)

For Wiegand format "clean" identifier code (without check bits) is passed .
For transparent format full received identifier code is passed (including assurance of bits) with the maximum length of 40 bits (long codes are cut).

STAT - status byte of analog inputs (8x type bool)

	-	-	-	-	VLD5	OUF5	VLD4	OUF4
Bit	.7	.6	.5	.4	.3	.2	.1	.0

OUFx - overflow / underflow of range of analog input AIx

VLDx - validity of reading of analog input AIx

AI4 - value of analog input AI4 (1x type real) [°C],[kΩ]

AI5 - value of analog input AI5 (1x type real) [°C],[kΩ]

3.30. C-WG-0503S

The value of temperature sensor is passed in °C (with resolution of 0.1°C), the value of general resistance in range 160kΩ is transferred in kΩ (with resolution of 10Ω).

DI - status of binary inputs and tamper (8x type bool)

	-	TAMPER5	TAMPER4	DI5	DI4	DI3	DI2	DI1
Bit	.7	.6	.5	.4	.3	.2	.1	.0

DIx - Current status of binary input DIx / alarm input x
TAMPERx - „tamper“ status of alarm input x

Output data

DOs

DOs - status of binary outputs (8x type bool)

	-	-	-	-	-	DO3	DO2	DO1
Bit	.7	.6	.5	.4	.3	.2	.1	.0

DO1 - value of binary output DO1 (Wiegand - buzzer)
DO2 - value of binary output DO2 (Wiegand - LED)
DO3 - value of binary output DO3 (Wiegand - LED)

3.31. C-WS-0200R

Wall switch module contains two short stroke buttons. The module can also connect 2 external temperature sensor to measure the ambient or any other temperature. Module is designed for Time and Element designs of ABB production. For actual offer of designs see the catalogue of Teco

The module is mechanically adapted for mounting on a standard installation flush box with a pitch of 60 mm fixing screws. Connection terminals for connection to the CIB bus and for external temperature sensors on the back side of the module.

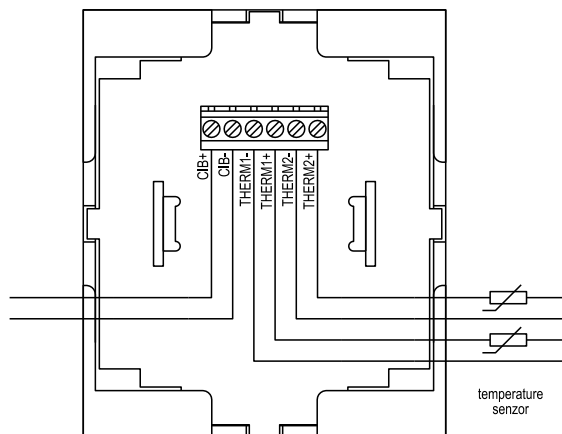

Fig. 3. 82 View and connection example

Tab. 3.31 Basic parameters C-WS-0200R

Binary inputs	
Quantity	2
Type	short stroke button
Temperature inputs	
Quantity	2
External sensor type	Thermistor NTC 12k
Range	0 ÷ +90 °C
Accuracy	1 °C
External sensor type	resistance input 0 ÷ 100kΩ
Power supply	
Power supply and communication	24 V (27 V) from the CIB
Nominal power consumption	20 mA
Galvanic isolation	No
Dimensions and weight	
Dimensions ¹⁾	88 × 81 × 21mm
Weight	60 g
Operating and installation conditions	
Operating temperature	-10 ÷ +55 °C
Storage temperature	-25 ÷ +70 °C
IP degree of protection acc. IEC 529	IP10B
Degree of pollution EN 60664	1
Operating position	Vertical
Type of operation	Continuous
Installation	Into the flush box
Connecting	screw type terminals
Cross-section of wires	max. 1,5 mm ²

1) Dimensions according the specifics of used design..

3.31.1. Configuration

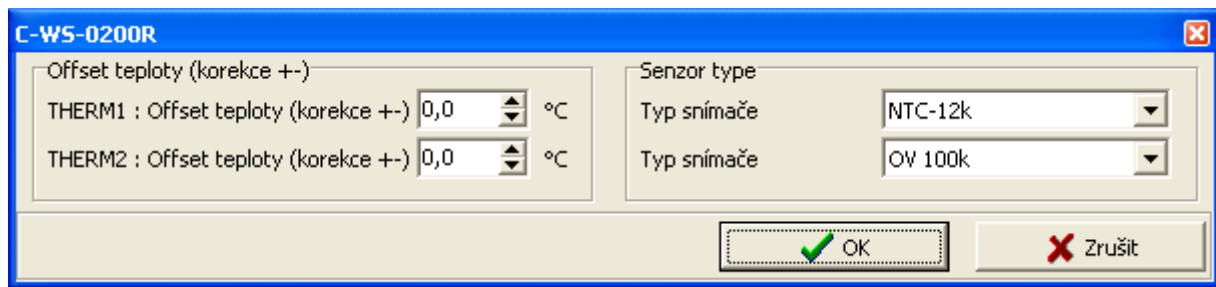

Fig. 3.83 Module configuration

Temperature offset

Correction offset of thermometer, which will be added on the measured temperature.

Type of sensor

Choosing type of temperature sensor:

- NTC 12k (negative thermistor, 12kΩ at 25°C), 0/+90°C
- OV100k (0 ÷ 100kΩ)

3.31.1. The structure of the transmitted data

Module contains 4 devices in total:

- device 1, input, 1*STAT (status of thermometer)
- device 2, input, 1*AI (thermometer 1)
- device 3, input, 1*AI (thermometer 2)
- device 4, input, 2*DI (buttons)

The devices are incorporated into the structure of the transmitted data, which is evident from window *I/O setting* in the Mosaic. Window is available after pressing icon  in toolbar.

Struktura dat	Úplný zápis	Alias	Svorka	Abs./délka	Hodnota
[-] ID1_IN : TMI_CIB1_ID1_IN	MI_CIB1_IN~ID1_IN				
[-] STAT : TCIB_AI2_STAT	MI_CIB1_IN~ID1_IN~STAT				\$00
[-] OUF1 : BOOL	MI_CIB1_IN~ID1_IN~STAT~OUF1			%R4.0	0
[-] VLD1 : BOOL	MI_CIB1_IN~ID1_IN~STAT~VLD1			%R4.1	0
[-] OUF2 : BOOL	MI_CIB1_IN~ID1_IN~STAT~OUF2			%R4.2	0
[-] VLD2 : BOOL	MI_CIB1_IN~ID1_IN~STAT~VLD2			%R4.3	0
[-] THERM1 : REAL	MI_CIB1_IN~ID1_IN~THERM1			%RF5	0
[-] THERM2 : REAL	MI_CIB1_IN~ID1_IN~THERM2			%RF9	0
[-] BTN : TCIB_WSB_BTN2	MI_CIB1_IN~ID1_IN~BTN				\$00
[-] UP1 : BOOL	MI_CIB1_IN~ID1_IN~BTN~UP1			%R13.0	0
[-] DOWN1 : BOOL	MI_CIB1_IN~ID1_IN~BTN~DOWN1			%R13.1	0

Fig. 3.84 The structure of the transmitted data

Input data

STAT	THERM1	THERM2	BTN
------	--------	--------	-----

STAT - status byte of analog inputs (8x type bool)

	-	-	-	-	VLD2	OUF2	VLD1	OUF1
Bit	.7	.6	.5	.4	.3	.2	.1	.0

- OUF1 - overflow / underflow of range of temperature input 1
- VLD1 - reading validity of temperature input 1
- OUF2 - overflow / underflow of range of temperature input 2
- VLD2 - reading validity of temperature input 2

THERM1 - value of analog/temperature input (type real) [°C],[kΩ]

THERM2 - value of analog/temperature input (type real) [°C],[kΩ]

The value of temperature sensor is transferred in °C (with resolution of 0.1°C), the value of general resistance in range 100kΩ is transferred in kΩ (with resolution of 10Ω).

BTN - status of buttons (8x type bool)

	-	-	-	-			DOWN1	UP1
Bit	.7	.6	.5	.4	.3	.2	.1	.0

- UP1 - status of button UP
- DOWN1 - status of button DOWN

3.32. C-WS-0400R

Wall switch module contains 4 short stroke buttons. The module can also connect 2 external temperature sensor to measure the ambient or any other temperature. Module is designed for Time and Element designs of ABB production. For actual offer of designs see the catalogue of Teco

The module is mechanically adapted for mounting on a standard installation flush box with a pitch of 60 mm fixing screws. Connection terminals for connection to the CIB bus and for external temperature sensors on the back side of the module.

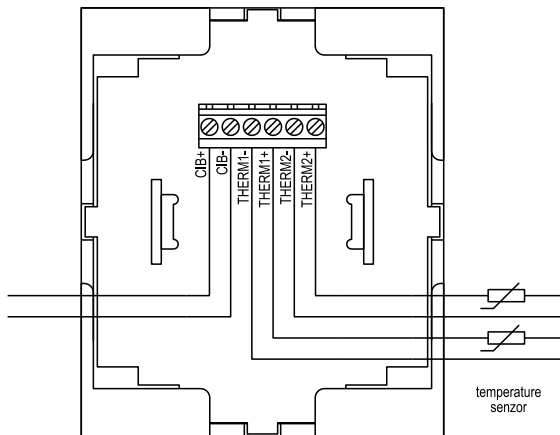

Fig. 3. 85 View and connection example

Tab. 3.32 Basic parameters C-WS-0400R

Binary inputs	
Quantity	4
Type	short stroke button
Temperature inputs	
Quantity	2
External sensor type	thermistor NTC 12kΩ(TC,TZ)
Range	0 ÷ +90 °C
Accuracy	1 °C
External sensor type	resistance input 0 ÷ 100kΩ
Power supply	
Power supply and communication	24 V (27 V) from the CIB
Nominal power consumption	20 mA
Galvanic isolation	No
Dimensions and weight	
Dimensions ¹⁾	88 × 81 × 21mm
Weight	60 g
Operating and installation conditions	
Operating temperature	-10 ÷ +55 °C
Storage temperature	-25 ÷ +70 °C
IP degree of protection acc. IEC 529	IP10B
Degree of pollution EN 60664	1
Operating position	Vertical
Type of operation	Continuous
Installation	Into the flush box
Connecting	screw type terminals
Cross-section of wires	max. 1,5 mm ²

1) Dimensions according the specifics of used design..

3.32.1. Configuration

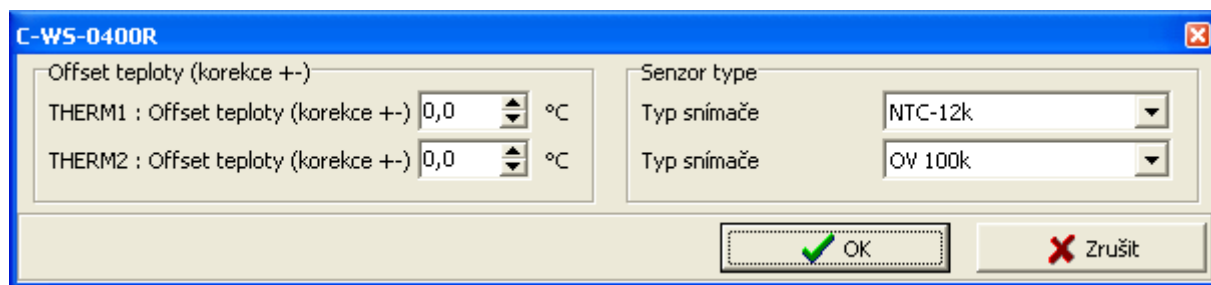

Fig. 3.86 Module configuration

Temperature offset

Correction offset of thermometer, which will be added on the measured temperature.

Type of sensor

Choosing type of temperature sensor:

- NTC 12k (negative thermistor, 12kΩ at 25°C), 0/+90°C
- OV100k (0 ÷ 100kΩ)

3.32.2. The structure of the transmitted data

Module contains 4 devices in total:

- device 1, input, 1*STAT (status of thermometer)
- device 2, input, 1*AI (thermometer 1)
- device 3, input, 1*AI (thermometer 2)
- device 4, input, 4*DI (buttons)

The devices are incorporated into the structure of the transmitted data, which is evident from window *I/O setting* in the Mosaic. Window is available after pressing icon  in toolbar.

Struktura dat	Úplný zápis	Alias	Svorka	Abs./délka	Hodnota
[-] ID1_IN : TCIB_CIB1_ID1_IN	MI_CIB1_IN~ID1_IN				
[-] STAT : TCIB_AI2_STAT	MI_CIB1_IN~ID1_IN~STAT				\$00
[-] OUF1 : BOOL	MI_CIB1_IN~ID1_IN~STAT~OUF1			%R4.0	0
[-] VLD1 : BOOL	MI_CIB1_IN~ID1_IN~STAT~VLD1			%R4.1	0
[-] OUF2 : BOOL	MI_CIB1_IN~ID1_IN~STAT~OUF2			%R4.2	0
[-] VLD2 : BOOL	MI_CIB1_IN~ID1_IN~STAT~VLD2			%R4.3	0
[-] THERM1 : REAL	MI_CIB1_IN~ID1_IN~THERM1			%RF5	0
[-] THERM2 : REAL	MI_CIB1_IN~ID1_IN~THERM2			%RF9	0
[-] BTN : TCIB_WSB_BTN4	MI_CIB1_IN~ID1_IN~BTN				\$00
[-] UP1 : BOOL	MI_CIB1_IN~ID1_IN~BTN~UP1			%R13.0	0
[-] DOWN1 : BOOL	MI_CIB1_IN~ID1_IN~BTN~DOWN1			%R13.1	0
[-] UP2 : BOOL	MI_CIB1_IN~ID1_IN~BTN~UP2			%R13.2	0
[-] DOWN2 : BOOL	MI_CIB1_IN~ID1_IN~BTN~DOWN2			%R13.3	0

Fig. 3.87 The structure of the transmitted data

Input data

STAT	THERM1	THERM2	BTN
------	--------	--------	-----

STAT - status byte of analog inputs (8x type bool)

	-	-	-	-	VLD2	OUF2	VLD1	OUF1
Bit	.7	.6	.5	.4	.3	.2	.1	.0

- OUF1 - overflow / underflow of range of temperature input 1
- VLD1 - reading validity of temperature input 1
- OUF2 - overflow / underflow of range of temperature input 2
- VLD2 - reading validity of temperature input 2

THERM1 - value of analog/temperature input (type real) [°C],[kΩ]

THERM2 - value of analog/temperature input (type real) [°C],[kΩ]

The value of temperature sensor is transferred in °C (with resolution of 0.1°C), the value of general resistance in range 100kΩ is transferred in kΩ (with resolution of 10Ω).

BTN - status of buttons (8x type bool)

	-	-	-	-	DOWN2	UP2	DOWN1	UP1
Bit	.7	.6	.5	.4	.3	.2	.1	.0

- UP1 - status of button UP1
- DOWN1 - status of button DOWN1
- UP2 - status of button UP2
- DOWN2 - status of button DOWN2

3.33. C-WS-0200R-Logus

Wall switch module contains two short stroke buttons, 2 LED indicators and internal thermometer. The module can also connect 2 external temperature sensor to measure the ambient or any other temperature. The module also includes 2 universal DI/AI inputs that can be configured for connection another switching buttons or to connect other analog sensors. The module is designed in a design you LOGUS.

The module is mechanically adapted for mounting on a standard installation flush box with a pitch of 60 mm fixing screws. Connection terminals for connection to the CIB bus and for external temperature sensors on the back side of the module.

3.33. C-WS-0200R-Logus

Tab. 3.33 Basic parameters C-WS-0200R-Logus

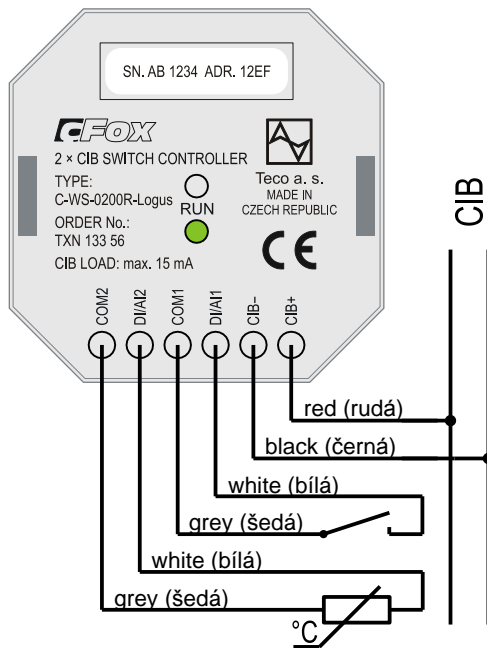

Fig. 3.88 View and connection example

Buttons	
Quantity	2
Type	short stroke button
LED indicators	
Quantity	2 + 1
Colour	1x red, 1x green + 1x green RUN
Internal thermometer	
Sensor type	thermistor NTC 12k Ω
Range	-10 \div +55 $^{\circ}$ C
Accuracy	\pm 1 $^{\circ}$ C
Temperature settling time	150 minutes
Universal DI/AI inputs	
Quantity	2
Optional types of inputs	Binary, Pt1000, Ni1000, NTC12k Ω , KTY81-121, resistance 100k Ω , voltage input
Binary input	NO potential-free contact
Pt1000	-90 \div +320 $^{\circ}$ C
Ni1000	-60 \div +200 $^{\circ}$ C
NTC 12k Ω	-40 \div +125 $^{\circ}$ C
KTY81-121	-55 \div +125 $^{\circ}$ C
Resistance input	0 \div 100k Ω
Voltage input	0 \div 2V
Accuracy	\pm 1 $^{\circ}$ C
Period of refresh AI	typically 5s
Power supply	
Power supply and communication	24 V (27 V) from the CIB
Nominal power consumption	15 mA
Galvanic isolation	No
Dimensions and weight	
Dimensions	86 \times 86 \times 38mm
Weight	79 g
Operating and installation conditions	
Operating temperature	-10 \div +55 $^{\circ}$ C
Storage temperature	-25 \div +70 $^{\circ}$ C
IP degree of protection acc. IEC 529	IP10B
Degree of pollution dle EN 60664	1
Operating position	Vertical
Type of operation	Continuous
Installation	Into the flush box
Connecting	wires 0.5mm ² , 90 mm

3.33.1. Configuration

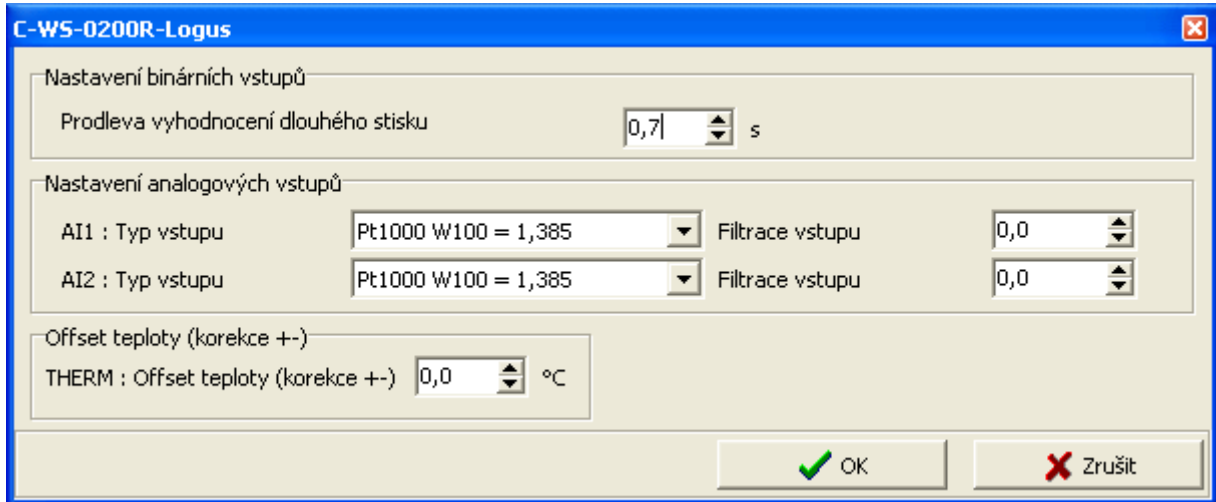

Fig. 3.89 Module configuration

The input terminals DI/AIx are **shared** for binary and analog inputs (for digital and analog equipment). As the input is configured as analog, **it is not possible** use it as binary input **in the same time**. Depending on the configured input (as enabled devices) specific items of configuration dialog are enabled/disabled. Enabling devices see. chap. 2.1 Master configuration, check the box *Show units, devices*

Delay, evaluation of long press

For binary (momentary button) inputs module directly evaluate the short and long presses on each input. By entering values one can set a delay time after which the activation of digital input DI is signalled as the long press (PRESS). Activating the digital input for period shorter than the entered value will be signalled by as the short press (CLICK). Delay period (T_{press}) can be inserted in the range 0.1÷2.5s.

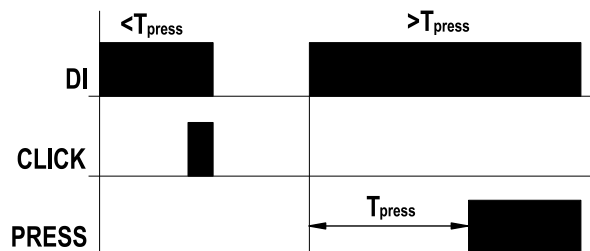

Fig. 3.90 Evaluation of short/long press

Type of input

Choosing the type of analog input:

- Pt1000, $W_{100} = 1,385$, $-90/+320^{\circ}\text{C}$
- Pt1000, $W_{100} = 1,391$, $-90/+320^{\circ}\text{C}$
- Ni1000, $W_{100} = 1,617$, $-60/+200^{\circ}\text{C}$
- Ni1000, $W_{100} = 1,500$, $-60/+200^{\circ}\text{C}$

NTC 12k (negative thermistor, 12kΩ at 25°C), -40/+125°C
KTY 81-121, -55/+125°C
OV100k (0 ÷ 100kΩ)
O ÷ 2V

Input filtering

By specifying a non-zero value of the time constant, the 1st order digital filter is activated. The filter is given by

$$y_t = \frac{y_{t-1} \cdot \tau + x}{\tau + 1}$$

x - the current value of the analog input
y_t - output
y_{t-1} - recent output
τ - time constant of the 1st order filter (TAU)

Value of time constant is set in the range 0.1 ÷ 25.4 and it represents a time constant in the range of 100 ms ÷ 25.4 s (value 255 is intended for service purposes).

Temperature offset

Correction offset of internal thermometer, which will be added on the measured temperature of internal thermometer.

3.33.2. The structure of the transmitted data

Module contains 5 devices in total:

- device 1, input/output, 2*BUTT+2*DI/2*LED
- device 2, input, 1*STAT (status of analog inputs)
- device 3, input, 1*AI (internal thermometer)
- device 4, input, 1*AI (AI1)
- device 5, input, 1*AI (AI2)

The devices are incorporated into the structure of the transmitted data, which is evident from window *I/O setting* in the Mosaic. Window is available after pressing icon  in toolbar.

CIB UNITS, MODULES

Struktura dat	Úplný zápis	Alias	Svorka	Abs./délka	Hodnota
[-] ID1_IN : TMI_CIB1_ID1_IN	MI_CIB1_IN~ID1_IN				
[-] DI : TCIB_CWS2LO_BTN	MI_CIB1_IN~ID1_IN~DI				
UP1 : BOOL	MI_CIB1_IN~ID1_IN~DI~UP1			%R4.0	0
DOWN1 : BOOL	MI_CIB1_IN~ID1_IN~DI~DOWN1			%R4.1	0
DI1 : BOOL	MI_CIB1_IN~ID1_IN~DI~DI1			%R4.4	0
DI2 : BOOL	MI_CIB1_IN~ID1_IN~DI~DI2			%R4.5	0
CLICK_UP1 : BOOL	MI_CIB1_IN~ID1_IN~DI~CLICK_UP1			%R5.0	0
CLICK_DOWN1 : BOOL	MI_CIB1_IN~ID1_IN~DI~CLICK_DOWN1			%R5.1	0
CLICK_DI1 : BOOL	MI_CIB1_IN~ID1_IN~DI~CLICK_DI1			%R5.4	0
CLICK_DI2 : BOOL	MI_CIB1_IN~ID1_IN~DI~CLICK_DI2			%R5.5	0
PRESS_UP1 : BOOL	MI_CIB1_IN~ID1_IN~DI~PRESS_UP1			%R6.0	0
PRESS_DOWN1 : BOOL	MI_CIB1_IN~ID1_IN~DI~PRESS_DOWN1			%R6.1	0
PRESS_DI1 : BOOL	MI_CIB1_IN~ID1_IN~DI~PRESS_DI1			%R6.4	0
PRESS_DI2 : BOOL	MI_CIB1_IN~ID1_IN~DI~PRESS_DI2			%R6.5	0
[-] STAT : TCIB_CWSLo_STAT	MI_CIB1_IN~ID1_IN~STAT			%R7 / 1	\$00
THERM : REAL	MI_CIB1_IN~ID1_IN~THERM			%RF8	0
AI1 : REAL	MI_CIB1_IN~ID1_IN~AI1			%RF12	0
AI2 : REAL	MI_CIB1_IN~ID1_IN~AI2			%RF16	0
[-] ID1_OUT : TMI_CIB1_ID1_OUT	MI_CIB1_OUT~ID1_OUT				\$00
[-] LED : TCIB_WSB_LED2	MI_CIB1_OUT~ID1_OUT~LED				\$00
GREEN1 : BOOL	MI_CIB1_OUT~ID1_OUT~LED~GREEN1			%R20.0	0
RED1 : BOOL	MI_CIB1_OUT~ID1_OUT~LED~RED1			%R20.1	0

Fig. 3.91 The structure of the transmitted data

Input data

DI	STAT	THERM	AI1	AI2
----	------	-------	-----	-----

DI - current status of the buttons and binary inputs, short and long pulses (24x type bool)

- UPx - status of button UPx
- DOWNx - status of button DOWNx
- DIx - current status on the binary input x
- CLICK_x - short pulse (to log. 1) on the binary input (button)
- PRESSx - long pulse (into log. 1) on the binary input (button)

STAT - status byte of analog inputs (8x type bool)

	-	-	VLD2	OUF2	VLD1	OUF1	iVLD	iOUF
Bit	.7	.6	.5	.4	.3	.2	.1	.0

- iOUF - overflow / underflow of internal thermometer range
- iVLD - internal thermometer reading validity
- OUFx - overflow / underflow of range of analog input AIx
- VLDx - validity of reading of analog input AIx

iTHERM - value of internal thermometer (type real) [°C]

AI1 - value of analog input 1 (type real) [°C],[kΩ]

3.33. C-WS-0200R-Logus

AI2 - value of analog input 2 (type real) [°C],[kΩ]

The value of temperature sensor is transferred in °C (with resolution of 0.1°C), the value of general resistance in range 100kΩ is transferred in kΩ (with resolution of 10Ω).

Output data

LED

LES - value of LED outputs (8x type bool)

	-	-	-	-	RED2	GREEN2	RED1	GREEN1
Bit	.7	.6	.5	.4	.3	.2	.1	.0

GREEN1 - output value of green LED

RED1 - output value of red LED

3.34. C-WS-0400R-Logus

Wall switch module contains 4 short stroke buttons, 4 LED indicators and internal thermometer. The module also includes 2 universal DI/AI inputs that can be configured for connection another switching buttons or to connect other analog sensors. The module is designed in a design you LOGUS.

The module is mechanically adapted for mounting on a standard installation flush box with a pitch of 60 mm fixing screws. Connection terminals for connection to the CIB bus and for external temperature sensors on the back side of the module.

3.34. C-WS-0400R-Logus

Tab. 3.34 Basic parameters C-WS-0400R-Logus

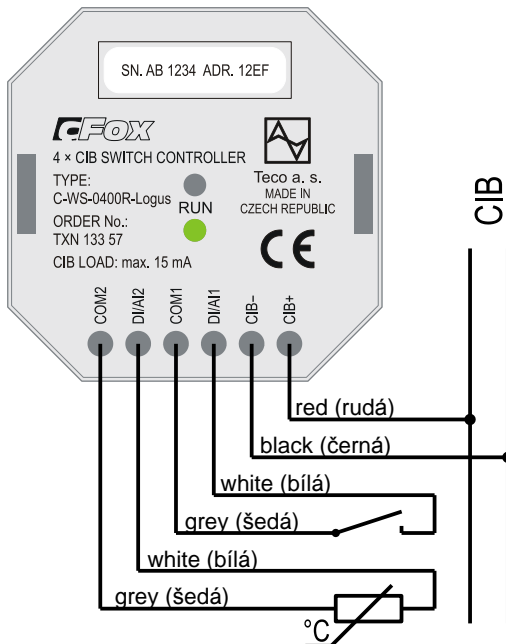
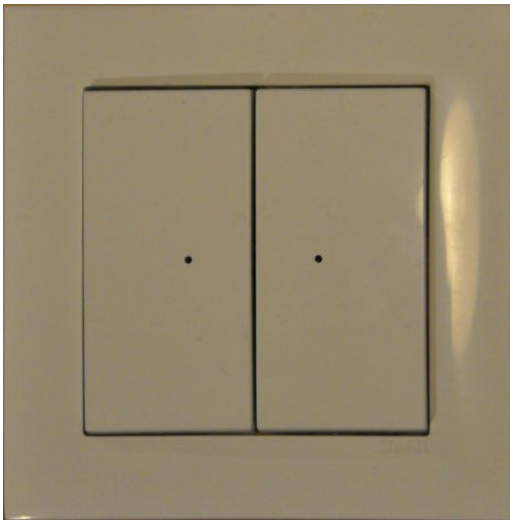

Fig. 3.92 View and connection example

Buttons	
Quantity	4
Type	short stroke button
LED indicators	
Quantity	4 + 1
Colour	2x red, 2x green + 1x green RUN
Internal thermometer	
Sensor type	thermistor NTC 12k Ω
Range	-10 \div +55 $^{\circ}$ C
Accuracy	\pm 1 $^{\circ}$ C
Temperature settling time	150 minutes
Universal DI/AI inputs	
Quantity	2
Optional types of inputs	Binary, Pt1000, Ni1000, NTC12k Ω , KTY81-121, resistance 100k Ω , voltage input
Binary input	NO (normally open) potential-free contact
Pt1000	-90 \div +320 $^{\circ}$ C
Ni1000	-60 \div +200 $^{\circ}$ C
NTC 12k Ω	-40 \div +125 $^{\circ}$ C
KTY81-121	-55 \div +125 $^{\circ}$ C
Resistance input	0 \div 100k Ω
Voltage input	0 \div 2V
Accuracy	\pm 1 $^{\circ}$ C
Period of refresh AI	typically 5s
Power supply	
Power supply and communication	24 V (27 V) from the CIB
Nominal power consumption	15 mA
Galvanic isolation	No
Dimensions and weight	
Dimensions	86 \times 86 \times 38mm
Weight	79 g
Operating and installation conditions	
Operating temperature	-10 \div +55 $^{\circ}$ C
Storage temperature	-25 \div +70 $^{\circ}$ C
IP degree of protection acc. IEC 529	IP10B
Degree of pollution dle EN 60664	1
Operating position	Vertical
Type of operation	Continuous
Installation	Into the flush box
Connecting	wires 0.5mm ² , 90 mm

3.34.1. Configuration

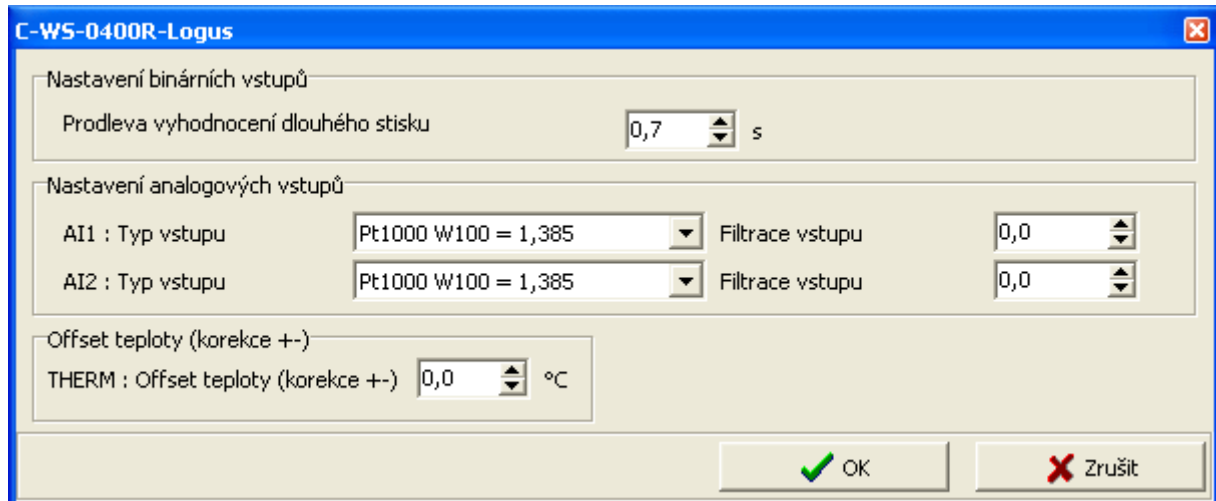

Fig. 3.93 Module configuration

The input terminals DI/AIx are **shared** for binary and analog inputs (for digital and analog equipment). As the input is configured as analog one, **it is not possible** use it as binary input **in the same time**. Depending on the configured input (as enabled devices) specific items of configuration dialog are enabled/disabled. Enabling devices see. chap. 2.1 *Master configuration*, check the box *Show units, devices*

Delay, evaluation of long press

For binary (momentary button) inputs module directly evaluate the short and long presses on each input. By entering values one can set a delay time after which the activation of digital input DI is signalled as the long press (PRESS). Activating the digital input for period shorter than the entered value will be signalled by as the short press (CLICK). Delay period (T_{press}) can be inserted in the range 0.1÷2.5s.

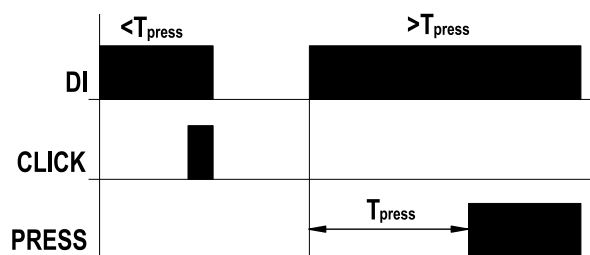

Fig. 3. 94 Evaluation of short/long press

Type of input

Choosing the type of analog input:

- Pt1000, $W_{100} = 1,385$, $-90/+320^{\circ}\text{C}$
- Pt1000, $W_{100} = 1,391$, $-90/+320^{\circ}\text{C}$
- Ni1000, $W_{100} = 1,617$, $-60/+200^{\circ}\text{C}$
- Ni1000, $W_{100} = 1,500$, $-60/+200^{\circ}\text{C}$
- NTC 12k (negative thermistor, $12\text{k}\Omega$ at 25°C), $-40/+125^{\circ}\text{C}$

KTY 81-121, -55/+125°C
OV100k (0 ÷ 100kΩ)
0 ÷ 2V

Input filtering

By specifying a non-zero value of the time constant, the 1st order digital filter is activated. The filter is given by

$$y_t = \frac{y_{t-1} \cdot \tau + x}{\tau + 1}$$

x - the current value of the analog input
y_t - output
y_{t-1} - recent output
τ - time constant of the 1st order filter (TAU)

Value of time constant is set in the range 0.1 ÷ 25.4 and it represents a time constant in the range of 100 ms ÷ 25.4 s (value 255 is intended for service purposes).

Temperature offset

Correction offset of internal thermometer, which will be added on the measured temperature of internal thermometer.

3.34.2. The structure of the transmitted data

Module contains 5 devices in total:

- device 1, input/output, 4*BUTT+2*DI/4*LED
- device 2, input, 1*STAT (status of analog inputs)
- device 3, input, 1*AI (internal thermometer)
- device 4, input, 1*AI (AI1)
- device 5, input, 1*AI (AI2)

The devices are incorporated into the structure of the transmitted data, which is evident from window *I/O setting* in the Mosaic. Window is available after pressing icon  in toolbar.

CIB UNITS, MODULES

Struktura dat	Úplný zápis	Alias	Svorka	Abs./délka	Hodnota
[-] ID1_IN : TMI_CIB1_ID1_IN	MI_CIB1_IN~ID1_IN				
[-] DI : TCIB_CWS4LO_BTN	MI_CIB1_IN~ID1_IN~DI				
UP1 : BOOL	MI_CIB1_IN~ID1_IN~DI~UP1			%R4.0	0
DOWN1 : BOOL	MI_CIB1_IN~ID1_IN~DI~DOWN1			%R4.1	0
UP2 : BOOL	MI_CIB1_IN~ID1_IN~DI~UP2			%R4.2	0
DOWN2 : BOOL	MI_CIB1_IN~ID1_IN~DI~DOWN2			%R4.3	0
DI1 : BOOL	MI_CIB1_IN~ID1_IN~DI~DI1			%R4.4	0
DI2 : BOOL	MI_CIB1_IN~ID1_IN~DI~DI2			%R4.5	0
CLICK_UP1 : BOOL	MI_CIB1_IN~ID1_IN~DI~CLICK_UP1			%R5.0	0
CLICK_DOWN1 : BOOL	MI_CIB1_IN~ID1_IN~DI~CLICK_DOWN1			%R5.1	0
CLICK_UP2 : BOOL	MI_CIB1_IN~ID1_IN~DI~CLICK_UP2			%R5.2	0
CLICK_DOWN2 : BOOL	MI_CIB1_IN~ID1_IN~DI~CLICK_DOWN2			%R5.3	0
CLICK_DI1 : BOOL	MI_CIB1_IN~ID1_IN~DI~CLICK_DI1			%R5.4	0
CLICK_DI2 : BOOL	MI_CIB1_IN~ID1_IN~DI~CLICK_DI2			%R5.5	0
PRESS_UP1 : BOOL	MI_CIB1_IN~ID1_IN~DI~PRESS_UP1			%R6.0	0
PRESS_DOWN1 : BOOL	MI_CIB1_IN~ID1_IN~DI~PRESS_DOWN1			%R6.1	0
PRESS_UP2 : BOOL	MI_CIB1_IN~ID1_IN~DI~PRESS_UP2			%R6.2	0
PRESS_DOWN2 : BOOL	MI_CIB1_IN~ID1_IN~DI~PRESS_DOWN2			%R6.3	0
PRESS_DI1 : BOOL	MI_CIB1_IN~ID1_IN~DI~PRESS_DI1			%R6.4	0
PRESS_DI2 : BOOL	MI_CIB1_IN~ID1_IN~DI~PRESS_DI2			%R6.5	0
[-] STAT : TCIB_CWSLo_STAT	MI_CIB1_IN~ID1_IN~STAT			%R7 / 1	\$00
THERM : REAL	MI_CIB1_IN~ID1_IN~THERM			%RF8	0
AI1 : REAL	MI_CIB1_IN~ID1_IN~AI1			%RF12	0
AI2 : REAL	MI_CIB1_IN~ID1_IN~AI2			%RF16	0
[-] ID1_OUT : TMI_CIB1_ID1_OUT	MI_CIB1_OUT~ID1_OUT				\$00
[-] LED : TCIB_WSB_LED4	MI_CIB1_OUT~ID1_OUT~LED				\$00
GREEN1 : BOOL	MI_CIB1_OUT~ID1_OUT~LED~GREEN1			%R20.0	0
RED1 : BOOL	MI_CIB1_OUT~ID1_OUT~LED~RED1			%R20.1	0
GREEN2 : BOOL	MI_CIB1_OUT~ID1_OUT~LED~GREEN2			%R20.2	0
RED2 : BOOL	MI_CIB1_OUT~ID1_OUT~LED~RED2			%R20.3	0

Fig. 3.95 The structure of the transmitted data

Input data

DI	STAT	THERM	AI1	AI2
----	------	-------	-----	-----

DI - current status of the buttons and binary inputs, short and long pulses (24x type bool)

- UPx - status of button UPx
- DOWNx - status of button DOWNx
- DIx - current status on the binary input x
- CLICK_x - short pulse (to log. 1) on the binary input (button)
- PRESSx - long pulse (into log. 1) on the binary input (button)

STAT - status byte of analog inputs (8x type bool)

	-	-	VLD2	OUF2	VLD1	OUF1	iVLD	iOUF
Bit	.7	.6	.5	.4	.3	.2	.1	.0

3.34. C-WS-0400R-Logus

*i*OUF - overflow / underflow of internal thermometer range
*i*VLD - internal thermometer reading validity
OUFx - overflow / underflow of range of analog input Alx
VLDx - validity of reading of analog input Alx

*i*THERM - value of internal thermometer (type real) [°C]

*A*11 - value of analog input 1 (type real) [°C],[kΩ]

*A*12 - value of analog input 2 (type real) [°C],[kΩ]

The value of temperature sensor is transferred in °C (with resolution of 0.1°C), the value of general resistance in range 100kΩ is transferred in kΩ (with resolution of 10Ω).

Output data

LED

LES - value of LED outputs (8x type bool)

	-	-	-	-	RED2	GREEN2	RED1	GREEN1
Bit	.7	.6	.5	.4	.3	.2	.1	.0

*GREEN*x - output value of green LEDx

*RED*x - output value of red LEDx

3.35. RCM2-1

Module is designed for office and residential interiors. It is intended for display and setting of desired temperature as a Control Room Manager. It Includes LCD to display one digital value and variety of graphic icons used in heating, ventilation, air conditioning. To navigate in the menu and edit values the module contain a rotary element with confirmation (pressing).

Internal temperature sensor is integrated in the module. The module also contains one input for connecting an external NTC temperature sensor and binary SSR output (Solid State Relay for heating controls, etc.).

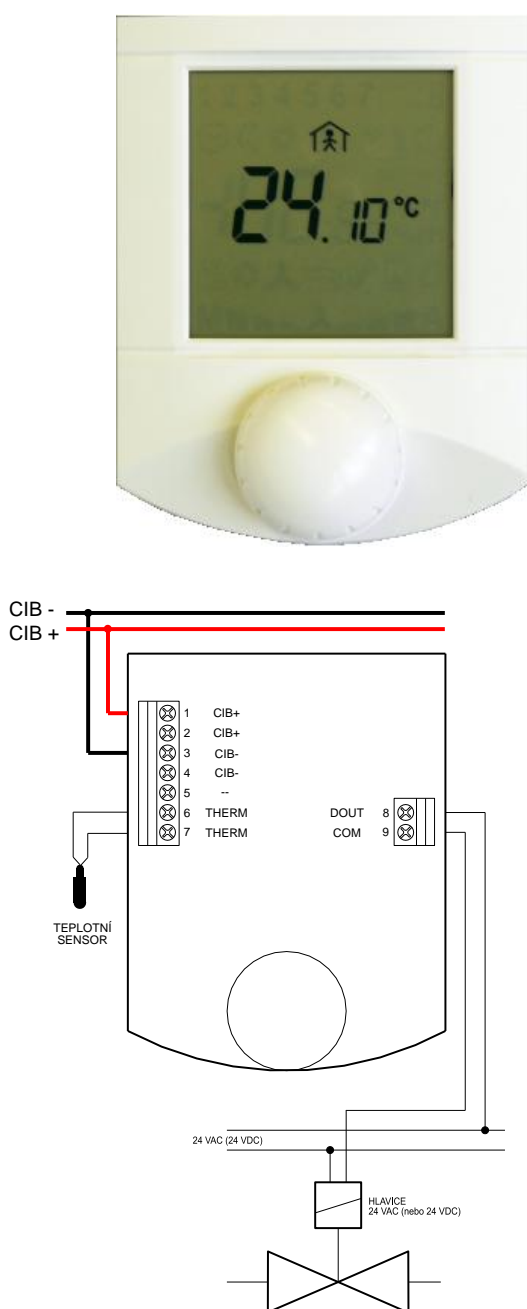

Tab. 3.35 Basic parameters RCM2-1

Display	
Type	LCD (to display one value + graphic symbols)
Control element	Roller with button
Analog input	
Quantity	2
Type of input	Temperature sensor (internal, external)
Sensor type	Thermistor NTC 12k
Range	-20 ÷ +100 °C
Accuracy	0,8 °C
Binary output	
Quantity	1
Type	SSR relay (Solid State Relay)
Galvanic isolation	Yes, 1500V
Typical Voltage	24 V AC/DC (max. 60 V)
Max. current	600 mA
Power supply	
Power supply and communication	24 V (27 V) from the CIB
Nominal power consumption	17mA
Dimensions and weight	
Dimensions	90 × 115 × 39mm
Weight	130g
Operating and installation conditions	
Operating temperature	0 ÷ +60 °C
Storage temperature	-30 ÷ +70 °C
Electrical strength	according to EN 60950
IP degree of protection acc. IEC 529	IP 20
Overvoltage category	III
Degree of pollution EN 61131-2	2
Operating position	Arbitrary
Mechanical design	Plastic box
Installation	On wall, on flush box
Connecting	screw type terminals
Cross-section of wires	max. 1,5 mm ²

Fig. 3.96 View and connection example RCM2-1

3.35.1. Configuration

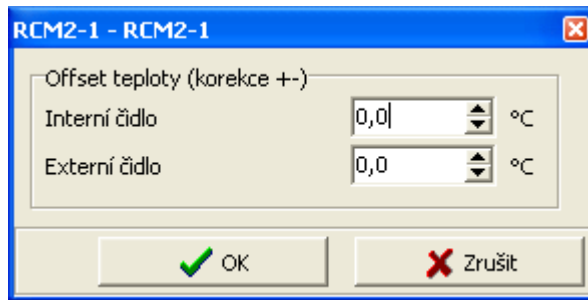

Fig. 3.97 Module configuration

Temperature offset

Correction offset of internal thermometer, which will be added on the measured temperature of internal thermometer.

3.35.2. The structure of the transmitted data

Module contains 5 devices in total:

- device 1, input, 3*DI (roller flags)
- device 2, output, DISP (values + symbols)
- device 3, input, 1*AI (internal thermometer)
- device 4, input, 1*AI (external thermometer)
- device 5, input, 1*AI (roller counter)

The devices are incorporated into the structure of the transmitted data, which is evident from window *I/O setting* in the Mosaic. Window is available after pressing icon  in toolbar.

Struktura dat	Úplný zápis	Alias	Svorka	Abs./délka	Hodnota
Statistic_MI_CIB1 : TCHStatistic	r0_p2_Statistic_MI_CIB1			%X0 / 10	
Control_MI_CIB1 : TCHControl	r0_p2_Control_MI_CIB1			%Y0 / 2	\$0000
ID1_IN : TMI_CIB1_ID1_IN	MI_CIB1_IN~ID1_IN				
FLG : TCIB_RCM_FLG	MI_CIB1_IN~ID1_IN~FLG				\$00
PRESS : BOOL	MI_CIB1_IN~ID1_IN~FLG~PRESS			%R4.0	0
LEFT : BOOL	MI_CIB1_IN~ID1_IN~FLG~LEFT			%R4.1	0
RIGHT : BOOL	MI_CIB1_IN~ID1_IN~FLG~RIGHT			%R4.2	0
iTHERM : REAL	MI_CIB1_IN~ID1_IN~iTHERM			%RF5	0
eTHERM : REAL	MI_CIB1_IN~ID1_IN~eTHERM			%RF9	0
Counter : SINT	MI_CIB1_IN~ID1_IN~Counter			%R13	0
ID1_OUT : TMI_CIB1_ID1_OUT	MI_CIB1_OUT~ID1_OUT				
VAL : TCIB_RCM_VAL	MI_CIB1_OUT~ID1_OUT~VAL				
VALUE : INT	MI_CIB1_OUT~ID1_OUT~VAL~VALUE			%RW14	0
ERROR : USINT	MI_CIB1_OUT~ID1_OUT~VAL~ERROR			%R16	0
ICO : TCIB_RCM_ICO	MI_CIB1_OUT~ID1_OUT~ICO				
ONE : BOOL	MI_CIB1_OUT~ID1_OUT~ICO~ONE			%R17.0	0
TWO : BOOL	MI_CIB1_OUT~ID1_OUT~ICO~TWO			%R17.1	0
THREE : BOOL	MI_CIB1_OUT~ID1_OUT~ICO~THREE			%R17.2	0

Fig. 3.98 The structure of the transmitted data

CIB UNITS, MODULES

Input data

FLG	iTHERM	eTHERM	COUNTER
-----	--------	--------	---------

- FLG** - roller status (8x type bool)
 PRESS - roller pressed (function of button)
 LEFT - anti-clockwise turning (when turning the value 1-0-1-0-...is passed)
 RIGHT clockwise turning (when turning the value 1-0-1-0-...is passed)

iTHERM - temperature of internal sensor (type real) [°C]

eTHERM - temperature of external sensor (type real) [°C]

COUNTER - cyclic counter of roller position (type sint)

Output data

VALUE	ERROR	ICO
-------	-------	-----

VALUE - value to be displayed on the main 7-segment display (type int)
 the value displayed depends on visibility segments S1 - S2 and D1 - D4

ERROR - value to be displayed on side 7-segment display (type usint)
 the value displayed depends on visibility segment D5

ICO - flags to control visibility of symbols / segments on display, binary output (48* type bool) (see following figure and table)

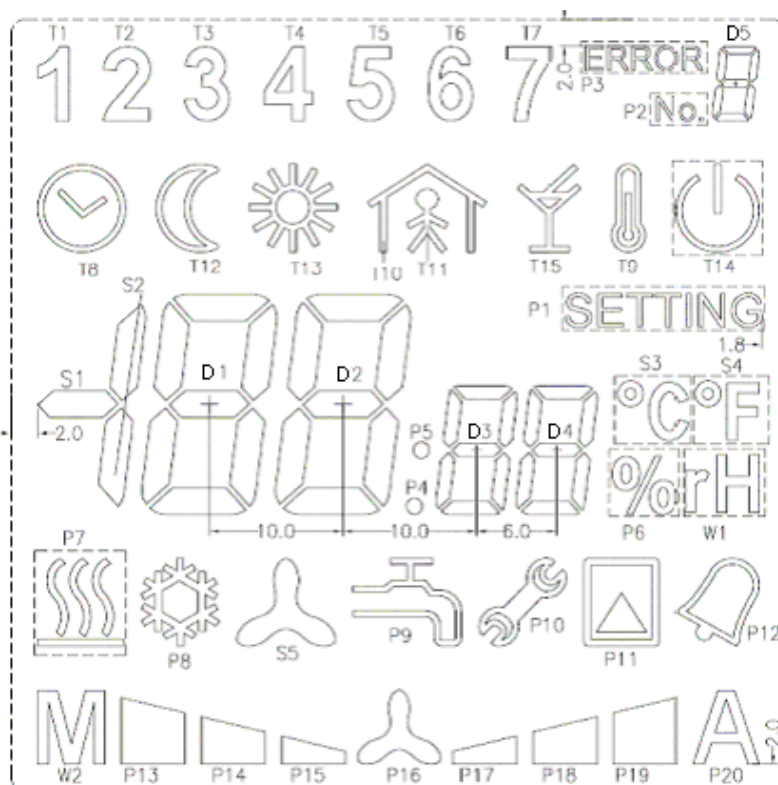

3.35. RCM2-1

Fig. 3. 99 Layout of symbols and segments on display RCM2-1

Icon / segment	Symbolic name
T1	ONE
T2	TWO
T3	THREE
T4	FOUR
T5	FIVE
T6	SIX
T7	SEVEN
P3	ERROR
P2	No
T8	Clock
T12	Moon
T13	Sun
T10	House
T11	Figure
T15	Drink
T9	Thermometer
T14	Power
P1	Setting
S3	Celsius
S4	Fahrenheit
P6	Percent
W1	rH
P5	dotUp
P4	dotDown
P7	Heating
P8	Cooling
S5	Ventilation
P9	Water
P10	Spanner
P11	P11
P12	Bell
W2	Manual
P13	LN3
P14	LN2
P15	LN1
P16	Rotation
P17	LP1
P18	LP2
P19	LP3
P20	Automatic
S1	Minus
S2	S2
D1	D1
D2	D2
D3	D3
D4	D4
D5	DE
binary output	DOUT

4. Attachments

Attachment 1

Order codes of CIB modules.

	Module identification	Order number
I	MI2-02M	TXN 131 28
II	CF-1141	TXN 111 41
1	C-AM-0600I	TXN 133 50
2	C-AQ-0001R	TXN 133 12
3	C-AQ-0002R	TXN 133 13
4	C-AQ-0003R	TXN 133 14
5	C-AQ-0004R	TXN 133 15
6	C-DL-0012S	TXN 133 23
7	C-DL-0064M	TXN 133 54
8	C-DM-0006M-ILED	TXN 133 46
9	C-DM-0006M-ULED	TXN 133 45
10	C-DM-0402M-RLC	TXN 133 58
11	C-HC-0201F-E	TXN 133 48
12	C-HM-0308M	TXN 133 24
13	C-HM-1113M	TXN 133 10
14	C-HM-1121M	TXN 133 11
15	C-IB-1800M	TXN 133 06
16	C-IR-0202S	TXN 133 25
17	C-IR-0203M	TXN 133 59
18	C-IT-0100H-A	TXN 133 17
19	C-IT-0100H-P	TXN 133 16
20	C-IT-0200I	TXN 133 09
21	C-IT-0200R	TXN 133 19
22	C-IT-0200S	TXN 133 29
23	C-IT-0504S	TXN 133 26
24	C-IT-0908S	TXN 133 52
25	C-OR-0008M	TXN 133 03
26	C-OR-0202B	TXN 133 02
27	C-RC-0002R	TXN 133 33
28	C-RC-0003R	TXN 133 37
29	C-RI-0401S	TXN 133 47
30	C-WG-0503S	TXN 133 53
31	C-WS-0200R	TXN 133 30
32	C-WS-0400R	TXN 133 31
33	C-WS-0200R-Logus	TXN 133 56
34	C-WS-0400R-Logus	TXN 133 57
35	RCM2-1	TXN 131 57

Notes

Notes



teco

Objednávky a informace:

Teco a. s. Havlíčkova 260, 280 58 Kolín 4, tel. 321 737 611, fax 321 737 633

TXV 004 13.01

The manufacturer reserves the right to change the documentation. The last issue is available on the Internet
www.tecomat.cz.